

MINISTRY OF NEW AND RENEWABLE ENERGY

SPECIFICATION FOR SOLAR PHOTOVOLTAIC WATER PUMPING SYSTEMS

1. SCOPE

These specification covers design qualifications and performance specifications for Centrifugal Solar Photo Voltaic (SPV) Water Pumping Systems to be installed on a suitable bore-well, open well, water reservoir, water stream, etc., and specifies the minimum standards to be followed under New Scheme for Farmers launched by Government of India on 8.3.2019.

2. TERMINOLOGY

In addition to the terminology specified in 3 of IS 5120 and IEC 62253, the following shall also apply.

2.1 Static Water Depth — It is the depth of water level below the ground level when the pump is not in operation.

2.2 Draw-Down — It is the elevation difference between the depth of static water level and the consistent standing water level in tube well during operation of pump set.

2.3 Submergence — It is the minimum height of water level after drawdown above the pump suction casing.

2.4 Manometric Suction Lift — Manometric suction lift is the vacuum gauge/suction manometer reading in meter of water column when pump operates at suction lift.

2.5 Static Suction Lift — Static suction lift/head is the vertical distance between sump water level and center of pump inlet.

2.6 Daily Water Output — It is the total water output on a clear sunny day with three times tracking SPV panel, under the “Average Daily Solar Radiation” condition of 7.15 KWh / m² on the surface of SPV array (i.e. coplanar with the SPV Modules).

2.7 Wire to Water Efficiency — It is the combined system efficiency of SPV Converter/Controller with Inbuilt MPPT mechanism, Pump set and piping.

2.8 SPV Controller — Pump Controller converts the DC voltage of the SPV array into a suitable DC or AC, single or multi-phase power and may also include equipment for MPPT, remote monitoring, and protection devices.

2.9 Maximum Power Point Tracker (MPPT) — MPPT is an algorithm that is included in the pump controller used for extracting maximum available power from SPV array under a given condition. The voltage at which SPV array can produce maximum power is called 'maximum power point' voltage (or peak power voltage).

3. CONSTRUCTIONAL FEATURES

3.1 General

3.1.1 SPV Water Pumping System set uses the irradiance available through SPV array. The SPV array produces DC power, which can be utilized to drive a DC or an AC pump set using pump controller.

3.2 A SPV Water Pumping system typically consists of:

3.2.1 Pump Set

Pump set may be of any one of the following types:

- i) Mono-set pump;
- ii) Open well submersible pump;
- iii) Submersible pump;

3.2.2 Motor

The motor of the pump set may be of the following types:

- i) AC Induction Motor.
- ii) DC Motor [PMSM/BLDC/SRM (with brush or brushless)].

3.2.3 SPV Controller See 2.8

Note: Some controllers are inbuilt in the motors

3.2.4 Provision for remote monitoring for the pumps must be made in the pump controller through an integral arrangement having following basic functions:

- Controller must be assigned with a unique serial number and its live status must be observed remotely on online portal through login credentials.
- Live status must indicate whether controller is ON/ OFF
- The parameter i.e. the water output, water flow rate, in fault condition, array input voltage/ current, power and motor frequency should at logged at an interval of 10 minutes
- Controller must have a back up to store the data locally (at least for 1 year)

3.3 Solar Photo Voltaic (SPV) Array

3.3.1 SPV arrays contains specified number of same capacity, type and specification modules connected in series or parallel to obtain the required voltage or current output. The SPV water pumping system should be operated with a PV array minimum capacity in the range of **900 Watts peak to 9000 Watts peak**, measured under Standard Test Conditions (STC). Sufficient number of modules in series and parallel could be used to obtain the required voltage or current output. The power output of individual PV modules used in the PV array, under STC, should be a minimum of 200 Watts peak, with adequate provision for measurement tolerances. Use of PV modules with higher power output is preferred.

3.3.2 Modules supplied with the SPV water pumping systems shall have certificate as per IS14286/IEC 61215 specifications or equivalent National or International/ Standards. STC performance data supplied with the modules shall not be more than one year old.

3.3.3 Modules must qualify to IS/IEC 61730 Part I and II for safety qualification testing.

3.3.4 The minimum module efficiency should be minimum 15 percent and fill factor shall be more than 70 percent.

3.3.5 Modules must qualify to IEC TS 62804-1:2015 for the detection of potential-induced degradation - Part 1: Crystalline silicon (Mandatory in case the SPV array voltage is more than 600 V DC)

3.3.6 In case the SPV water pumping systems are intended for use in coastal areas the solar modules must qualify to IEC TS 61701:2011 for salt mist corrosion test.

3.3.7 The name plate shall conform the IS 14286/IEC 61215

3.3.8 Module to Module wattage mismatch in the SPV array mismatch shall be within ± 3 percent.

3.3.9 Variation in overall SPV array wattage from the specified wattages shall be within zero percent to +10 percent.

3.3.10 The PV Modules must be warranted for output wattage, which should not be less than 90% of the rated wattage at the end of 10 years and 80% of the rated wattage at the end of 25 years.

3.4 Motor-Pump Set

3.4.1 The SPV water pumping systems may use any of the following types of motor pump sets:

- a) Surface mounted motor-pump set
- b) Submersible motor-pump set
- c) Floating motor-pump set
- d) Any other type of motor pump set after approval from Ministry.

3.4.2 The “Motor-Pump Set” should have a capacity in the range of 1 HP to 10 HP and should have the following features:

- a) The mono block DC/ AC centrifugal motor pump set with the impeller mounted directly on the motor shaft and with appropriate mechanical seals which ensures zero leakage.
- b) The motor of the capacity ranging from 1 HP to 10 HP should be AC/DC. The suction and delivery head will depend on the site specific condition of the field.
- c) Submersible pumps could also be used according to the dynamic head of the site at which the pump is to be used.

3.4.3 The pump and all external parts of motor used in submersible pump which are in contact with water, should be of stainless steel of grade 304 or higher as required. The motor-pump set should have a 5 years warranty and therefore, it is essential that the construction of the motor and pump should be made using parts which have a much higher durability and do not need replacement or corrode for at least 5 years of operation after installation.

3.4.5 The suction/ delivery pipe shall be of HDPE or uPVC column pipes of appropriate size, electric cables, floating assembly, civil work and other fittings required to install the Motor Pump set. In case of HDPE pipes the minimum pressure rating of 8 kg/sqcm-PE100 grade for pumps up to 3 HP, 10 kg/sqcm-PE100 grade for 5 HP pumps and further higher minimum pressure rating for above 5 HP as appropriate shall be used.

3.5 Module Mounting Structures and Tracking System

3.5.1 The PV modules should be mounted on metallic structures of adequate strength and appropriate design, which can withstand load of modules and high wind velocities up to 150 km per hour. The raw material used and process for manufacturing of module mounting structure including welding of joints should conform to applicable IS. The module mounting structure should be hot dip galvanized according to IS 4759. Zinc content in working area of the hot dip galvanizing bath should not be less than 99.5% by mass.

3.5.2 To enhance the performance of SPV water pumping systems arrangement for seasonal tilt angle adjustment and three times manual tracking in a day should be provided. In order to make structure rigid, the gap between Telescopic pattern supports should be minimal, further, for bearing of center load of whole structure only pins should be used instead of threaded bolts.

3.5.3 The general hardware for structure fitment should be either SS 304 or 8.8 grade. Modules should be locked with antitheft bolts of SS 304 Grade. Foundation should be as per the site condition, based on the properties of Soil. Foundation can be done either with the help of 'J Bolt' (refer IS 5624 for foundation hardware) or direct piling, it should be decided as per the site and relevant IS i.e. IS 6403 / 456 / 4091 / 875 should be referred for foundation design.

3.5.4 Details of Module Mounting Structure for different capacity of SPV pumps are attached at Annexure-I. These are indicative of minimum standards and an Implementing Agency may specify higher standards.

3.6 SPV Controller

3.6.1 Maximum Power Point Tracker (MPPT) shall be included to optimally use the power available from the SPV array and maximize the water discharge.

3.6.2 The SPV Controller must have IP (65) protection or shall be housed in a cabinet having at least IP (65) protection.

3.6.3 Adequate protections shall be provided in the SPV Controller to protect the solar powered pump set against the following:

- a) Dry running;
- b) Open circuit;
- c) Accidental output short circuit;
- d) Under voltage;
- e) Reverse polarity;
- f) SPD to arrest high current surge; and
- g) Lightning arrestor.

3.6.4 A good reliable DC Circuit Breaker as per IS/IEC 60947-2 suitable for switching DC power ON and OFF shall be provided in the SPV Controller.

3.6.5 All cables used shall be as per IS 694. Suitable size of cable shall be used in sufficient length for inter-connection between the SPV array to SPV Controller and the SPV Controller to solar powered pump set. Selection of the cable shall be as per IS 14536.

3.6.6 Controller shall be integrated with GSM/GPRS Gateway with Geo tagging. GSM/GPRS Charges to be included in the Costing till the end of Warranty period of the Pump set.

3.7 Earthing Arrangement

3.7.1 Earthing of the motor shall be done as per IS 9283 in accordance with the relevant provisions of IS 3043. Separate earthing shall be provided for Controller, pump and SPV array.

3.7.2 For safety purpose, it shall be ensured during installation that the earthing is capable of taking care of leakage current.

3.7.3 In case of uPVC/HDPE pipes used as discharge pipe, a separate non-corrosive, low resistance conductor from motor earth terminal to control panel earth terminal shall be provided for earthing.

3.7.4 A lightening arrestor shall be provided with every SPV Water Pumping System.

3.8 Use of indigenous components

It will be mandatory to use indigenously manufactured solar modules with indigenous mono/multi crystalline silicon solar cells. Further, the motor-pump-set, controller and balance of system should also be manufactured indigenously. The vendor has to declare the list of imported components used in the solar water pumping system.

4. PERFORMANCE REQUIREMENTS

4.1 Under the “Average Daily Solar Radiation” condition of 7.15 KWh / sq.m. on the surface of PV array (i.e. coplanar with the PV Modules), the minimum water output from a Solar PV Water Pumping System at different “Total Dynamic Heads” should be as specified below :

For D.C. Motor Pump Set:

- i) 110 liters of water per watt peak of PV array, from a Total Dynamic Head of 10 meter (Suction head, if applicable, maximum of 7 meter) and with the shut off head being at least 12 meter.
- ii) 55 liters of water per watt peak of PV array, from a Total Dynamic Head of 20 meter (Suction head, if applicable, up to a maximum of 7 meters) and with the shut off head being at least 25 meter.
- iii) 38 liters of water per watt peak of PV array, from a Total Dynamic Head of 30 meters and the shut off head being at least 45 meter.
- iv) 23 liters of water per watt peak of PV array, from a Total Dynamic Head of 50 meter and the shut off head being at least 70 meter.

- v) 15 liters of water per watt peak of PV array, from a Total Dynamic Head of 70 meters and the shut off head being at least 100 meter.
- vi) 10.5 liters of water per watt peak of PV array, from a Total Dynamic Head of 100 meters and the shut off head being at least 150 meter.

The actual duration of pumping of water on a particular day and the quantity of water pumped could vary depending on the solar intensity, location, season, etc.

Indicative performance specifications for the Shallow and Deep well SPV Water Pumping Systems are given in the Annexure II.

For A.C. Induction Motor Pump Set:

- i) 99 liters of water per watt peak of PV array, from a Total Dynamic Head of 10 meter (Suction head, if applicable, maximum of 7 meters) and with the shut off head being at least 12 meter.
- ii) 49 liters of water per watt peak of PV array, from a Total Dynamic Head of 20 meter (Suction head, if applicable, up to a maximum of 7 meters) and with the shut off head being at least 25 meter.
- iii) 35 liters of water per watt peak of PV array, from a Total Dynamic Head of 30 meter and the shut off head being at least 45 meter.
- iv) 21 liters of water per watt peak of PV array, from a Total Dynamic Head of 50 meter and the shut off head being at least 70 meter.
- v) 14 liters of water per watt peak of PV array, from a Total Dynamic Head of 70 meter and the shut off head being at least 100 meter.
- vi) 9 liters of water per watt peak of PV array, from a Total Dynamic Head of 100 meter and the shut off head being at least 150 meter.

The actual duration of pumping of water on a particular day and the quantity of water pumped could vary depending on the solar intensity, location, season, etc.

Indicative performance specifications for the Shallow and Deep well SPV Water Pumping Systems are given in the Annexure III.

5. TESTS FOR HYDRAULIC AND ELECTRICAL PERFORMANCE OF PUMPSET

5.1 The motor-pump set shall be tested independently for hydraulic and electrical performance as per the relevant IS specification including following test

- a) Constructional requirements/features
- b) General requirements
- c) Design features
- d) Insulation resistance test

- e) High voltage test
- f) Leakage current test

5.2 Testing of SPV Water Pumping Systems shall be done as per procedure specified by the MNRE.

6. GUARANTEE OF PERFORMANCE

6.1 The SPV Water Pumping Systems shall be guaranteed for their performance of the nominal volume rate of flow and the nominal head at the guaranteed duty point as specified in 7.1 under the “Average Daily Solar Radiation” condition of 7.15 KWh/m² on the surface of SPV array (i.e. coplanar with the Photo Voltaic (PV) Modules). The actual duration of pumping of water on a particular day and the quantity of water pumped could vary depending on the solar intensity, location, season, etc.

6.2 Solar Photo Voltaic Water Pumping Systems shall be guaranteed by the manufacturer against the defects in material and workmanship under normal use and service for a period of at least 60 months from the date of commissioning.

6.3 Sufficient spares for trouble free operation during the Warrantee period should be made available as and when required

7. MARKING AND PARAMETERS TO BE DECLARED BY THE MANUFACTURER

7.1 The motor pump-set and Controller used in SPV Water Pumping Systems shall be securely marked with the following parameters declared by the manufacturer:

7.1.1 Motor Pump-set

- a) Manufacturer's name, logo or trade-mark;
- b) Model, size and SI No of pump-set;
- c) Motor Rating (kW / HP);
- d) Total head, m, at the guaranteed duty point;
- e) Capacity (LPD) at guaranteed head;
- f) Operating head range, m;
- g) Maximum Current (A);
- j) Voltage Range (V) and;
- k) Type - AC or DC Pump set; &
- l) Photo Voltaic (PV) Array Rating in Watts peak (W_p)

7.1.2 Controller

- a) Manufacturer's name, logo or trade-mark;
- b) Model Number;
- c) Serial Number;

- d) Voltage Range;
- e) Power Range in kW for Controller; and
- f) Current rating (A)

8. OPERATION AND MAINTENANCE MANUAL

8.1 An Operation and Maintenance Manual, in English and the local language, should be provided with the solar PV pumping system. The Manual should have information about solar energy, photovoltaic, modules, DC/AC motor pump set, tracking system, mounting structures, electronics and switches. It should also have clear instructions about mounting of PV module, DO's and DONT's and on regular maintenance and Trouble Shooting of the pumping system. Helpline number and Name and address of the Service Centre and contact number of authorized representative to be contacted in case of failure or complaint should also be provided. A warranty card for the modules and the motor pump set should also be provided to the beneficiary.

**Specifications for Dual Axis Manual Tracking Type
Module Mounting Structure (MMS) for Solar Water Pumping System**

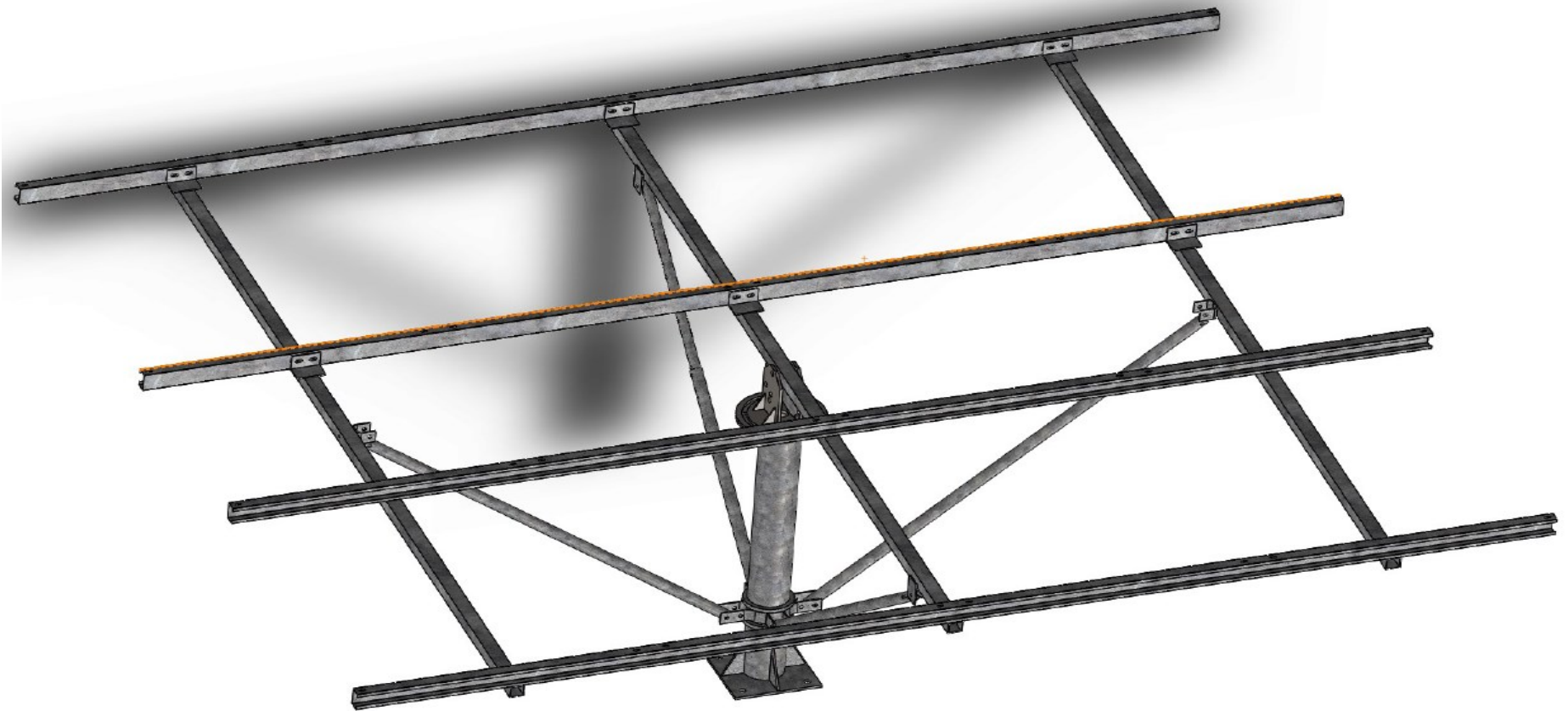

Standard MMS for 4, 6 and 8 solar modules have been specified. These standard MMS may be used in combinations for different capacities of solar water pumping systems as follows:

1. Standard MMS of 4 Modules for 1 HP
2. Standard MMS of 6 Modules for 2 HP
3. Combination of standard MMS of 4 Modules and 6 Modules for 3 HP
4. Combination of two standard MMS of 8 Modules for 5 HP
5. Combination of three standard MMS of 8 Modules for 7.5 HP

and so on....

Specifications of main parts used in MMS are given below:

1. Centre Shaft: - Centre shaft used in structure should be of minimum 139 OD with minimum thickness of 4 mm with base plate minimum 10 mm thickness if used and foundation hardware should be as per IS 5624. For system without base plate i.e. direct piling is should be as per the site condition based on the properties of Soil and refer (IS 6403 / 456 / 4091 / 875) for foundation design.
2. Rafters: - The Main and secondary rafter used in structure should be of either SHS & RHS pipe sections.
3. Purlin: - Mounting Purlins used in the structure should be made of Cold form steel section as per IS 1079 with minimum thickness of 2mm.

4. Provision for Seasonal Tilt: - In one structure at least four telescopic supports (three may be used in MMS for 4 modules) either round hollow sections or square hollow section to be provided to support the mounting structure.
5. Provision for Daily Tracking: - Provision for Daily tracking should be provided by the way of providing min. 8 mm thick metal sheet with precision cut grooves.
6. Module Locking System: - Modules should be locked with antitheft bolts of SS 304 Grade.
7. General Hardware for Structure Fitment: - Either SS 304 or 8.8 grade hardware should be used for fitment.
8. Hot Dip Galvanizing: - All structure parts should be hot dip galvanized according to IS 4759.
9. Tolerance for fabrication: - Tolerance for fabrication of steel structure should as per IS 7215.
10. Welding: - Welding should be done as per IS: - 822 & grade of welding wire should be (ER70S-6).

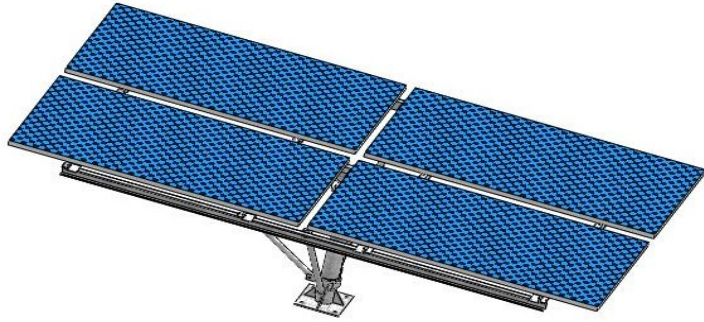

4 Module MMS

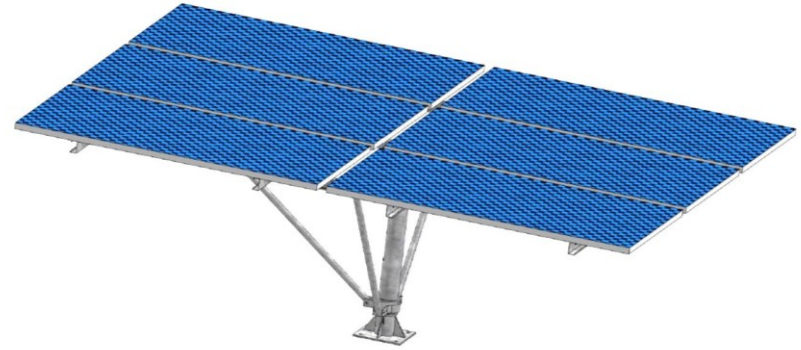

6 Module MMS



8 Module MMS

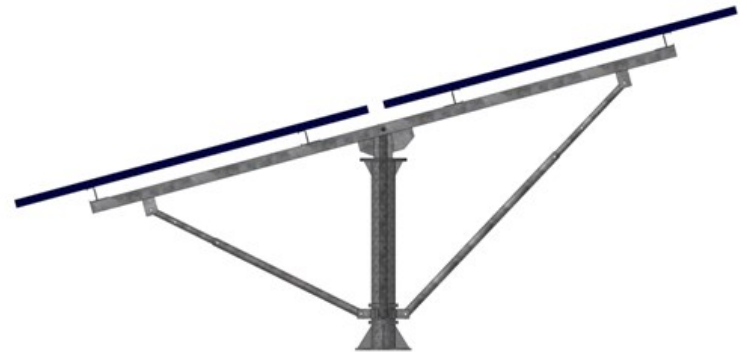

Side view

Raw material test certificates (MTC) of all types of raw material used in dual axis manual tracking type MMS as per appropriate IS code should be submitted along with dispatch documents.

Tests to be performed on Dual Axis Manual Tracking Type MMS for Solar Water Pumping System: -

1. For ascertaining proper welding of structure part following should be referred.
 - a. Weld wire grade should be of grade **(ER 70 S - 6)**
 - b. D.P. Test (Pin Hole / Crack) **(IS 822)**
2. For ascertaining hot dip galvanizing of fabricated structure following should be referred: -
 - a. Min coating required should be as per IS 4759.
 - b. Testing of galvanized material.
 - i. Preece Test (CuSO₄ Dip Test) **(IS 2633)**
 - ii. Mass of Zinc **(IS 6745)**
 - iii. Adhesion Test **(IS 2629)**

Part1 – Mail Column

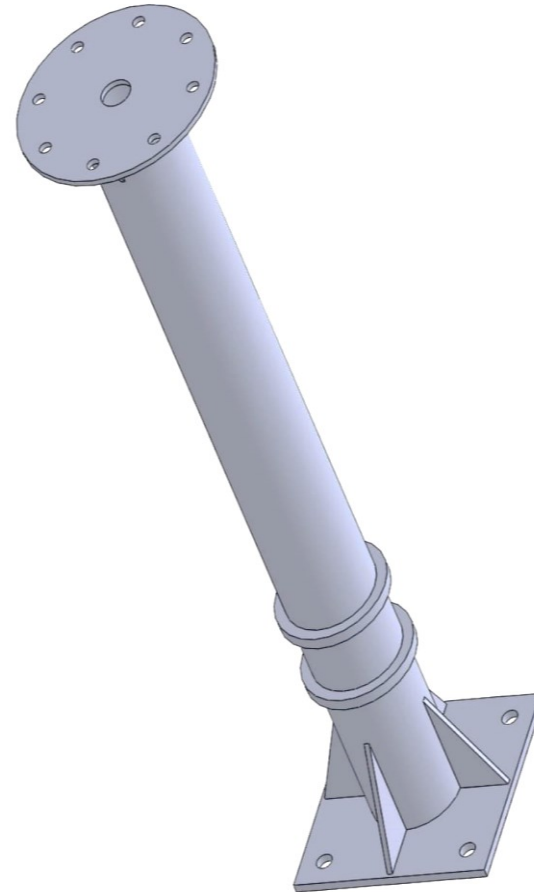
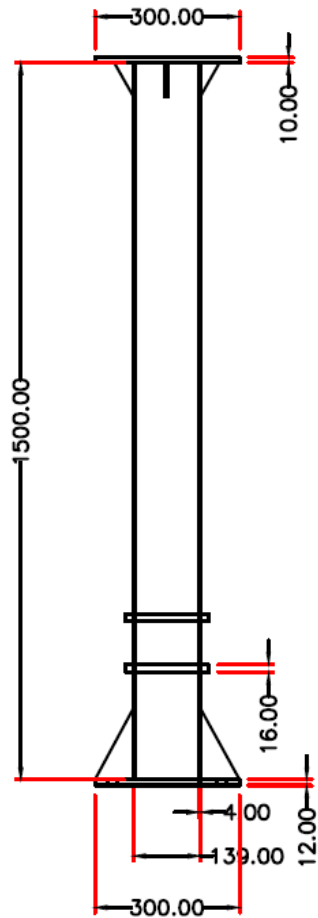

Notes: -

1. All Dimensions are in mm.
2. Main Column material grade should be YST - 240 as per: -IS: 1161 / 1239 & E250 as per: - IS: 1079 / 2062.

Part 2 – Top Plate

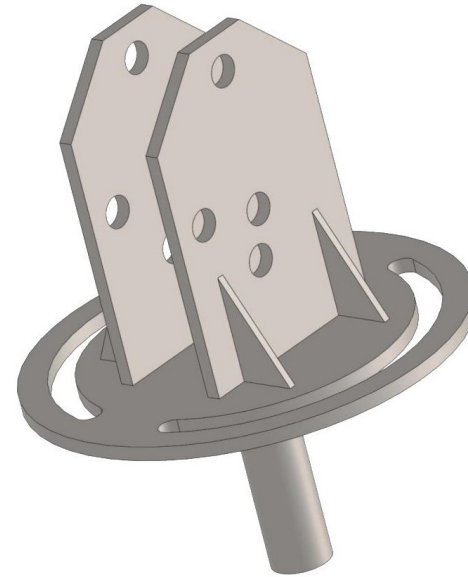
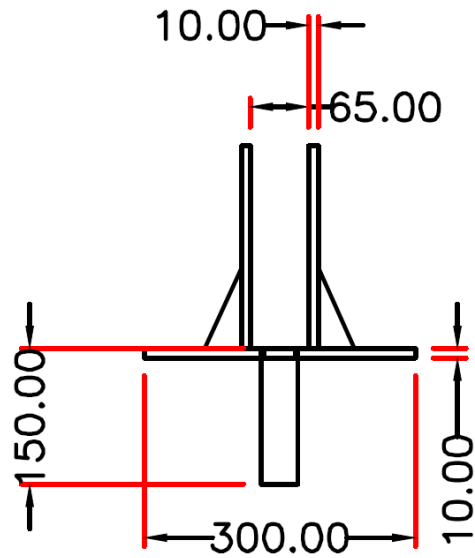

Notes: -

1. All Dimensions are in mm.
2. Top Plate material grade should be YST - 240 as per: -IS: 1161 / 1239 & E250 as per: - IS: 1079 / 2062.

Part 3 – Main Tube

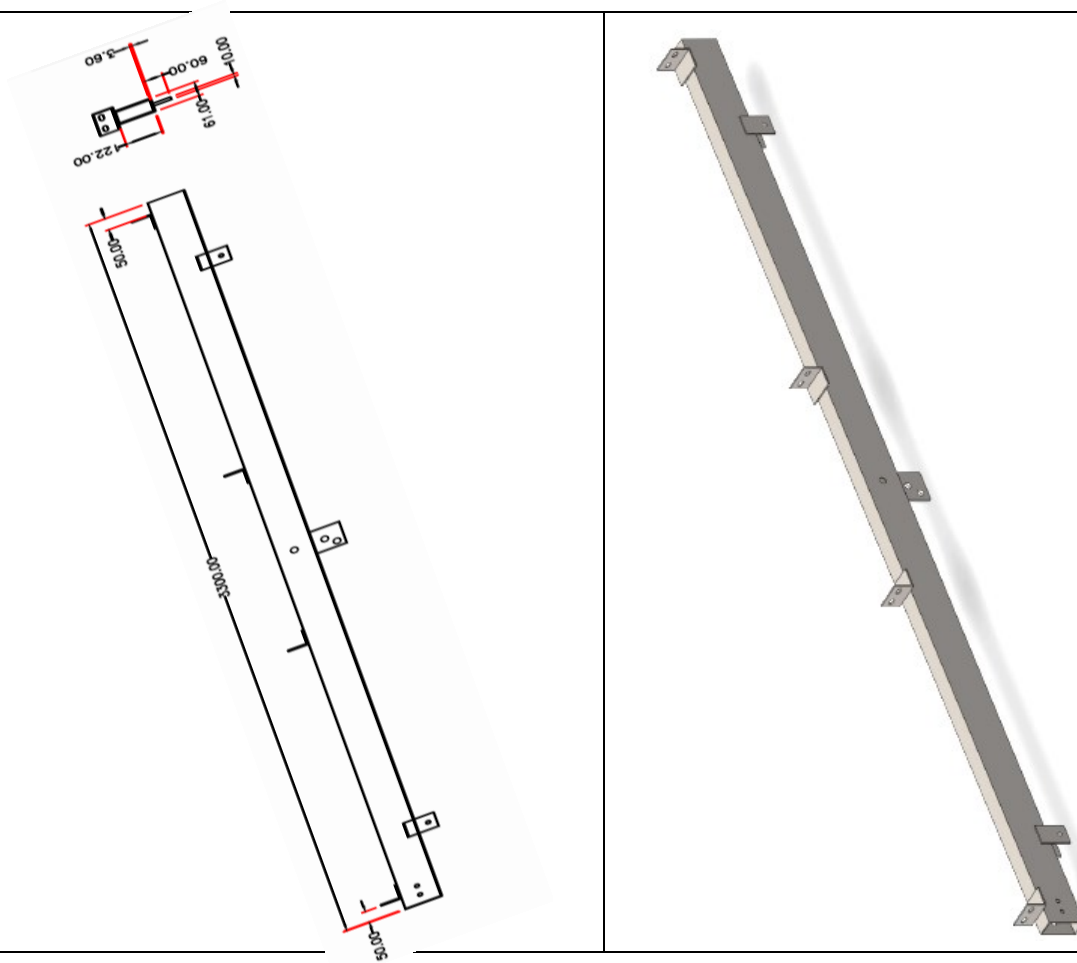

Notes: -

1. All Dimensions are in mm.
2. Main Tube material grade should be YST - 240 as per: -IS: 1161 / 1239 & E250 as per: - IS: 1079 / 2062.

Part 4 – Side Tube

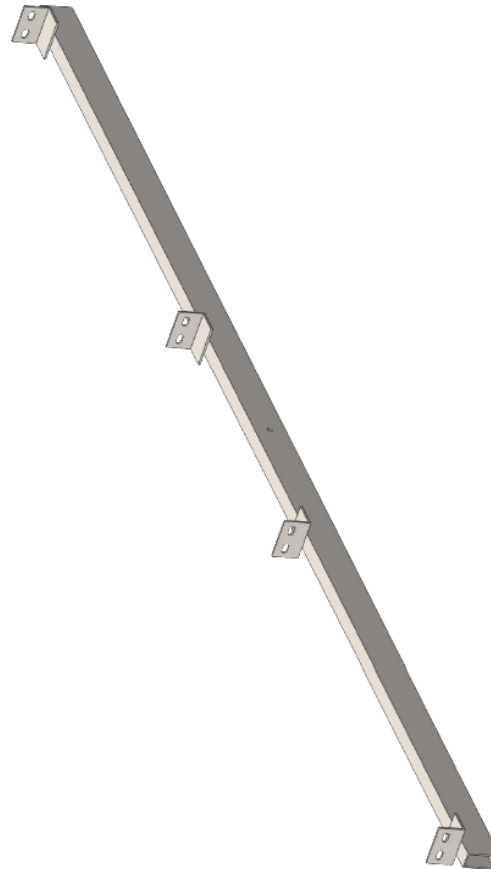
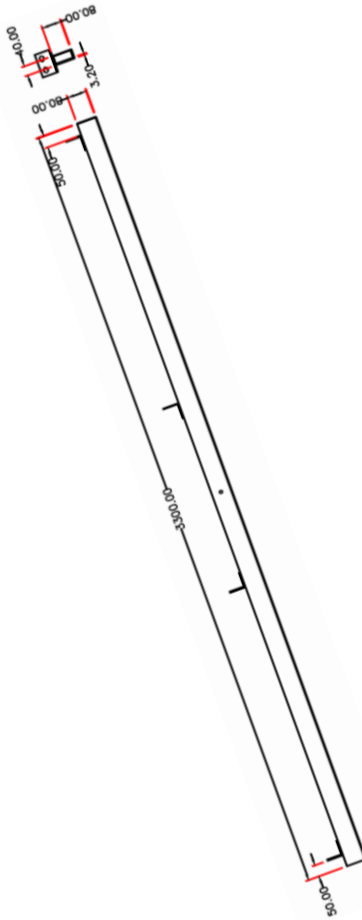

Notes: -

1. All Dimensions are in mm.
2. Side Tube material grade should be YST - 240 as per: -IS: 1161 / 1239 & E250 as per: - IS: 1079 / 2062.

Part 5 – Purlin

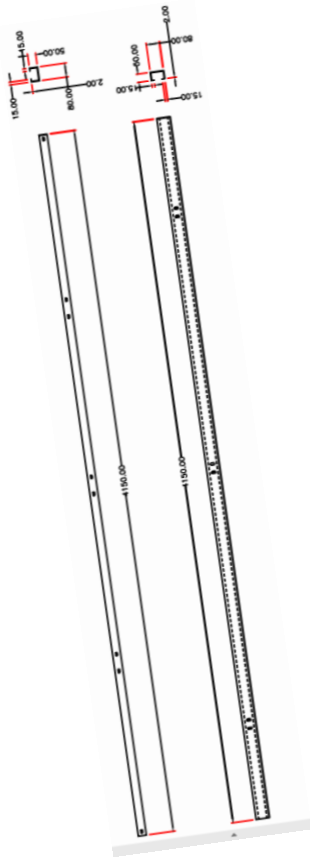

Notes: -

1. All Dimensions are in mm.
2. Mounting Purlin material grade should be E250 as per: - IS: 1079 / 2062 & IS: 811.

Part 6 – Clamp with Blade

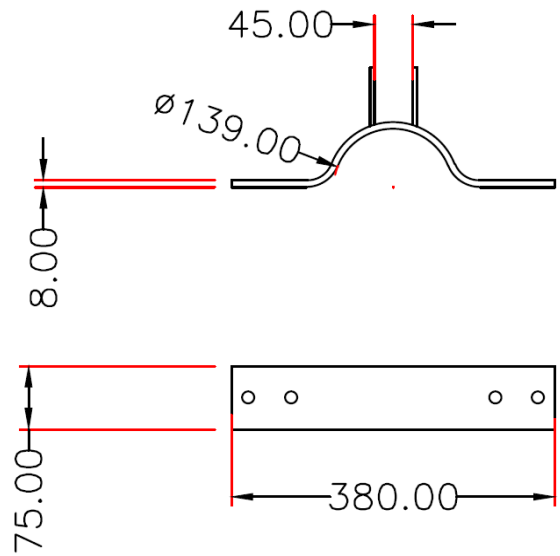

Notes: -

1. All Dimensions are in mm.
2. Clamp with Blade material grade should be as per: - IS: 1079 & E250 as per: - IS: 2062.

Part 7 – Supporting Pipes

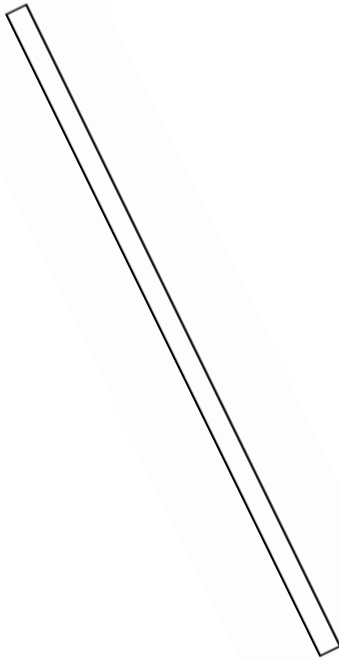

Notes: -

1. All Dimensions are in mm.
2. Supporting Pipes material grade should be YST - 240 as per: -IS: 1161 / 1239 & E250 as per: - IS: 1079 / 2062.

Bill of Quantity for main parts of MMS for Solar Water Pumping System

SR. NO.	PART NAME	CROSS SECTION DETAIL	LENGTH (MM)	QUANTITY PER SET
A	Common for MMS for 4, 6 and 8 Modules			
1.	MAIN POLE	139 OD	1500	1
2.	TOP PLATE	300 OD	--	1
3.	CLAMP WITH BLADE	75X8	380	2
4.	SUPPORTING PIPES	41 OD & 33 OD	--	6
B	Different for MMS for 4, 6 and 8 Modules			
5.	MAIN TUBE			
	4 and 6 Module	60X60X3.6	3300	1
	8 Modules	122X61X3.6	3300	1
6.	SIDE TUBE			
	4 and 6 Module	50X50X3.6	3300	2
	8 Modules	80X40X3.2	3300	2
7.	MOUNTING PURLIN			
	4 Module	80X50X15X2	2050	4
	6 Module	80X50X15X2	3100	4
	8 Modules	80X50X15X2	4150	4

FOUNDATION DESIGN FOR 4/6 MMS

BOM

TMT BAR	LENGTH	WEIGHT	QUANTITY	TOTAL WEIGHT
16 MM	1000 MM	1.578 KG	8 PCS	12.6 KG
8 MM	2400 MM	0.950 KG	4 PCS	3.8 KG
8 MM	1250 MM	0.500 KG	4 PCS	2 KG

BOM

BLOCK	WIDTH	LENGTH	HEIGHT	VOLUME
RCC COLUMN	0.600 M	0.600 M	0.900 M	0.324 CU.M
PCC	0.900 M	0.900 M	0.200 M	0.162 CU.M

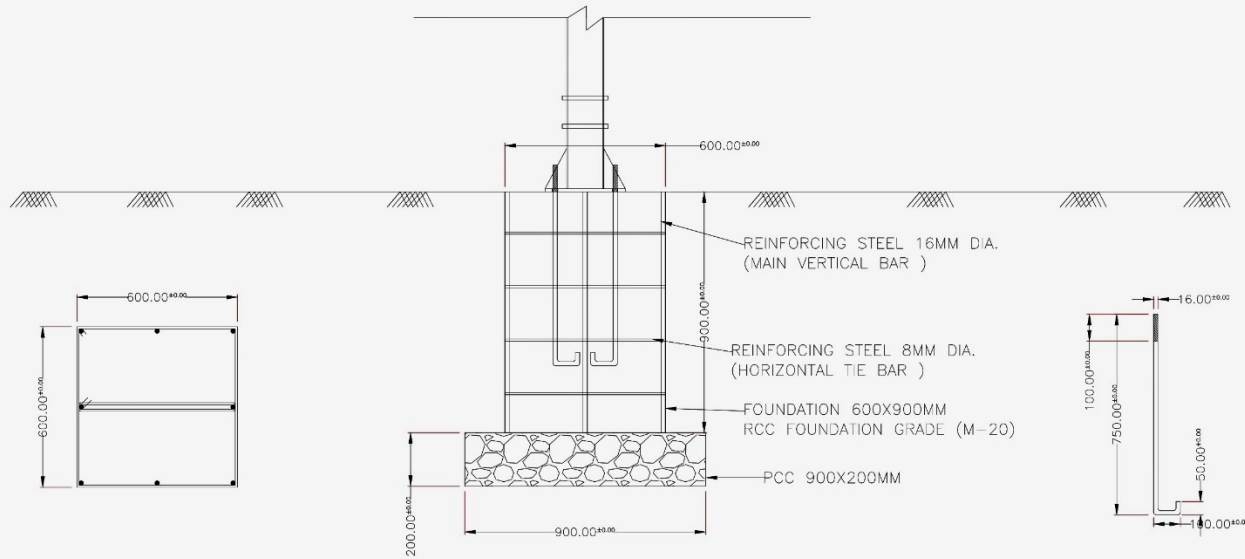

Note:-All dimensions are critical & in mm. Please maintain the dimensions. Welding dimension should be maintained 5 mm.

FOUNDATION DESIGN FOR 8 MMS

BOM

TMT BAR	LENGTH	WEIGHT	QUANTITY	TOTAL WEIGHT
16 MM	1300 MM	2.05 KG	8 PCS	16.4 KG
8 MM	2400 MM	0.950 KG	6 PCS	5.7 KG
8 MM	1250 MM	0.500 KG	6 PCS	3 KG

BOM

BLOCK	WIDTH	LENGTH	HEIGHT	VOLUME
RCC COLUMN	0.600 M	0.600 M	1.20 M	0.432 CU.M
PCC	0.900 M	0.900 M	0.200 M	0.162 CU.M

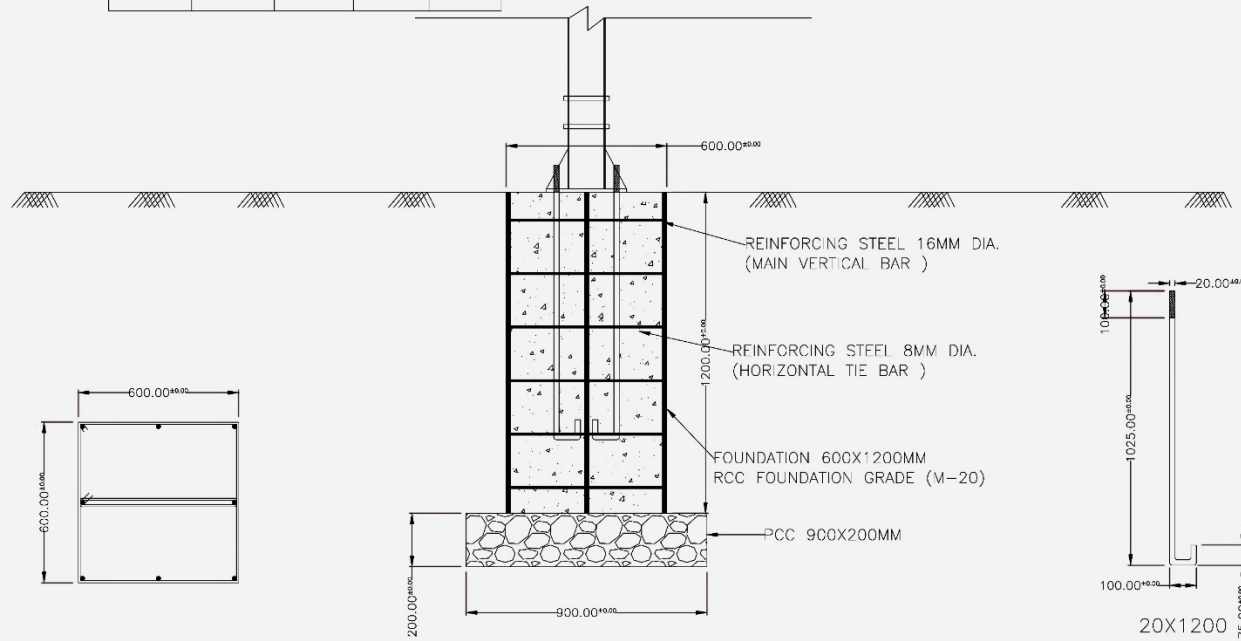

Note:-All dimensions are critical & in mm. Please maintain the dimensions. Welding dimension should be maintained 5 mm.

ANNEXURE – II

Indicative Technical Specifications of Shallow Well (Surface) Solar Pumping Systems with D.C. Motor Pump Set with Brushes or Brushless D.C. (B.L.D.C.)

Description	Model-I	Model-II	Model-III	Model-IV	Model-V	Model-VI	Model-VII	Model-VIII	Model-IX	Model-X	Model-XI	Model-XII	Model-XIII
PV array (Wp)	900	1800	2700	2700	4800	4800	4800	6750	6750	6750	9000	9000	9000
Motor Pump-set capacity (HP)	1	2	3	3	5	5	5	7.5	7.5	7.5	10	10	10
Shut Off Dynamic Head (meters)	12	12	12	25	12	25	45	12	25	45	12	25	45
Water output * (Liters per day)	99000 (from a total head of 10 meters)	198000 (from a total head of 10 meters)	297000 (from a total head of 10 meters)	148500 (from a total head of 20 meters)	528000 (from a total head of 10 meters)	264000 (from a total head of 20 meters)	182400 (from a total head of 30 meters)	742500 (from a total head of 10 meters)	371250 (from a total head of 20 meters)	256500 (from a total head of 30 meters)	990000 (from a total head of 10 meters)	495000 (from a total head of 20 meters)	342000 (from a total head of 30 meters)

* Water output figures are on a clear sunny day with three times tracking of SPV panel, under the “Average Daily Solar Radiation” condition of 7.15 kWh/ sq.m. on the surface of PV array (i.e. coplanar with the PV Modules).

Notes:

1. Suction head, if applicable, maximum 7 meters.
2. For higher or lower head / PV capacity, or in between various models; water output could be decided as per the clause 4 (i.e. Performance Requirements) specified earlier.
3. If submersible pumps are used in lieu of surface pumps, the water output must match that of the surface pumps as specified in this table.

ANNEXURE – II (CONTD.)

Indicative Technical Specifications of Solar Deep well (submersible) Pumping Systems with D.C. Motor Pump Set with Brushes or Brushless D.C. (B.L.D.C.)

Description	Model-I	Model-II	Model-III	Model-IV	Model-V	Model-VI	Model-VII	Model-VIII	Model-IX	Model-X	Model-XI	Model-XII	Model-XIII	Model-XIV
PV array (Wp)	1200	1800	3000	3000	3000	4800	4800	4800	6750	6750	6750	9000	9000	9000
Motor Pump-set capacity (HP)	1	2	3	3	3	5	5	5	7.5	7.5	7.5	10	10	10
Shut Off Dynamic Head (meters)	45	45	45	70	100	70	100	150	70	100	150	70	100	150
Water output * (Liters per day)	45600 (from a total head of 30 meters)	68400 (from a total head of 30 meters)	114000 (from a total head of 30 meters)	69000 (from a total head of 50 meters)	45000 (from a total head of 70 meters)	110400 (from a total head of 50 meters)	72000 (from a total head of 70 meters)	50400 (from a total head of 100 meters)	155250 (from a total head of 50 meters)	101250 (from a total head of 70 meters)	70875 (from a total head of 100 meters)	207000 (from a total head of 50 meters)	135000 (from a total head of 70 meters)	94500 (from a total head of 100 meters)

* Water output figures are on a clear sunny day with three times tracking of SPV panel, under the “Average Daily Solar Radiation” condition of 7.15 kWh/ sq.m. on the surface of PV array (i.e. coplanar with the PV Modules).

Notes:

1. For higher or lower head / PV capacity, or in between various models; water output could be decided as per the clause 4 (i.e. Performance Requirements) specified earlier.
2. If surface pumps are used in lieu of submersible pumps, the water output must match that of the submersible pumps as specified in this table.

ANNEXURE – III

Indicative Technical Specifications of Shallow Well (Surface) Solar Pumping Systems with A.C. Induction Motor Pump Set

Description	Model-I	Model-II	Model-III	Model-IV	Model-V	Model-VI	Model-VII	Model-VIII	Model-IX	Model-X	Model-XI	Model-XII	Model-XIII
PV array (Wp)	900	1800	2700	2700	4800	4800	4800	6750	6750	6750	9000	9000	9000
Motor Pump-set capacity (HP)	1	2	3	3	5	5	5	7.5	7.5	7.5	10	10	10
Shut Off Dynamic Head (meters)	12	12	12	25	12	25	45	12	25	45	12	25	45
Water output * (Liters per day)	89100 (from a total head of 10 meters)	178200 (from a total head of 10 meters)	267300 (from a total head of 10 meters)	132300 (from a total head of 20 meters)	475200 (from a total head of 10 meters)	235200 (from a total head of 20 meters)	168000 (from a total head of 30 meters)	641025 (from a total head of 10 meters)	330750 (from a total head of 20 meters)	236250 (from a total head of 30 meters)	890000 (from a total head of 10 meters)	441000 (from a total head of 20 meters)	324000 (from a total head of 30 meters)

* Water output figures are on a clear sunny day with three times tracking of SPV panel, under the “Average Daily Solar Radiation” condition of 7.15 kWh/ sq.m. on the surface of PV array (i.e. coplanar with the PV Modules).

Notes:

1. Suction head, if applicable, maximum 7 meters.
2. For higher or lower head / PV capacity, or in between various models; water output could be decided as per the clause 4. (i.e. Performance Requirements) specified earlier.
3. If submersible pumps are used in lieu of surface pumps, the water output must match that of the surface pumps as specified in this table.

ANNEXURE – III (CONTD.)

Indicative Technical Specifications of Solar Deep well (submersible) Pumping Systems with A.C. Induction Motor Pump Set

Description	Model-I	Model-II	Model-III	Model-IV	Model-V	Model-VI	Model-VII	Model-VIII	Model-IX	Model-X	Model-XI	Model-XII	Model-XIII	Model-XIV
PV array (Wp)	1200	1800	3000	3000	3000	4800	4800	4800	6750	6750	6750	9000	9000	9000
Motor Pump-set capacity (HP)	1	2	3	3	3	5	5	5	7.5	7.5	7.5	10	10	10
Shut Off Dynamic Head (meters)	45	45	45	70	100	70	100	150	70	100	150	70	100	150
Water output * (Liters per day)	42000 (from a total head of 30 meters)	63000 (from a total head of 30 meters)	105000 (from a total head of 30 meters)	63000 (from a total head of 50 meters)	42000 (from a total head of 70 meters)	100800 (from a total head of 50 meters)	67200 (from a total head of 70 meters)	43200 (from a total head of 100 meters)	141750 (from a total head of 50 meters)	94500 (from a total head of 70 meters)	60750 (from a total head of 100 meters)	189000 (from a total head of 50 meters)	126000 (from a total head of 70 meters)	81000 (from a total head of 100 meters)

* Water output figures are on a clear sunny day with three times tracking of SPV panel, under the “Average Daily Solar Radiation” condition of 7.15 kWh/ sq.m. on the surface of PV array (i.e. coplanar with the PV Modules).

Notes:

1. For higher or lower head / PV capacity, or in between various models; water output could be decided as per the clause 4 (i.e. Performance Requirements) specified earlier.
2. If surface pumps are used in lieu of submersible pumps, the water output must match that of the submersible pumps as specified in this table.