



ENERGY EFFICIENCY SERVICES LIMITED
(A JV of PSUs of Ministry of Power, Govt. of India)

(CONTRACTS DEPARTMENT)
(OPEN TENDER)

SECTION-1

DETAILED INVITATION FOR BIDS (IFB)

FOR

Name of the Work: Design, Manufacture, Supply, Transport, Installation, Testing and Commissioning of approximate 1,75,000 numbers of Off Grid Solar Photovoltaic Water Pumping Systems in selected States on PAN India basis, including complete system warranty and its repair and maintenance for 5 Years under MNRE off-grid and decentralized solar PV applications scheme on behalf of State Nodal Agencies (SNAs).

NIT/Bid Document No.: EESL/06/2019-20/KUSUM/SWPS /Phase-1/Off Grid//192007012

Dated: 21-08-2019

EESL invites E-bids from eligible bidders for the aforesaid work under Single-stage Three-envelope Bidding Process **THROUGH E-TENDERING***. For details about the IFB, please refer to the details that follow. Any amendment(s)/corrigendum/clarification(s) with respect to this Tender shall be uploaded on the E-Procurement website only. The bidders should keep themselves updated by regularly visiting the E-Procurement website of EESL for any amendment/corrigendum/ clarification in regard to this Tender.

Thanking you,

Yours faithfully,
for & on behalf of EESL

(Deepak Mittal)
Officer (SCM)

*The bids for E-tenders will be submitted online on the web site <https://eesl.eproc.in>. Oral, telephonic, telegraphic bids or those submitted in hard copies/physical form will not be entertained. In case, anything to the contrary is mentioned anywhere in the Tender, the same should be ignored.

NIT/Bid Document No.: EESL/06/2019-20/KUSUM/SWPS /Phase-1/Off
Grid//192007012

Signature :-
CN=DDEEPAK MITTAL, ST=DELHI, OID.2.5.4.17=110003, OU=CONTRACTS AN
PROCUREMENT, O=ENERGY EFFICIENCY SERVICES LIMITED, C=IN
User ID : deepak.mittal
Serial No : F3FA77

SECTION-1 (IFB)

Page 1 of 5



BID DETAILS

NIT/Bid Document No.	EESL/06/2019-20/KUSUM/SWPS /Phase-1/Off Grid//192007012	
Bidding Document Cost	Rs. 25,000/- (Rupees Twenty Five Thousand Only) (non-refundable & non-adjustable).	
Earnest Money Deposit (EMD)/ Bid Security	State	EMD amount (in Crores)
	Andhra Pradesh	3.05
	Telangana	0.12
	Chhattisgarh	1.83
	Madhya Pradesh	1.54
	Rajasthan	3.05
	Tamil Nadu	3.05
	Haryana	1.83
	Punjab	0.55
	Bihar	0.31
	West Bengal	0.09
	Odisha	0.31
	Gujarat	0.50
	Maharashtra	1.1
	Jharkhand	1.22
	Uttar Pradesh	1.83
	Himachal Pradesh	0.23
	Jammu & Kashmir	0.15
	Uttarakhand	0.04
	Meghalaya	0.23
Mizoram	0.03	
Tripura	0.17	
Assam	0.09	
	<p>If bidder wants to participate in more than one Cluster, then EMD shall be as total of EMD required for respective states. For e.g. If bidder is willing to participate in AP and Telangana then EMD submitted shall be (Rs. 3.05 Cr + Rs. 0.12 Cr) = Rs. 3.17 Cr.</p> <p><u>Bidders/s to ensure the fulfilment of EMD requirement. In case bidder/s quoted for multiple Clusters and the EMD requirement of the multiple Clusters is not meeting as per above table, the bid of that bidder will be summarily rejected with no correspondence/ clarification in this regard.</u> (EMD to be valid up to 225 days beyond the date of techno-commercial bid opening).</p>	
Security Deposit/ Contract Performance Guarantee/Security	Please refer section 4 for the same	
Document Sale Date & Timing, i.e., Last date & time for	From 21/08/2019 to 11/09/2019 (up to 1100 hours IST).	



downloading RfP from website	
Online Bid Submission Period	From 21/08/2019 to 11/09/2019 (up to 1130 hours IST).
Techno-commercial E-bid Opening Date & Time	11/09/2019, at 1200 hrs. IST.
Pre-bid Meeting	28/08/2019 at 1130 hrs. IST.
Bid Validity Duration	180 days from the date of opening of techno-commercial bid.
Bid Documents Sections in this Tender	Section-2 – Information to Bidders (ITB). Section-3 – General Conditions of Contract (GCC). Section-4 – Technical Specification and Special Conditions of Contract (SCC). Section-5 – Measurement and Verification. Section-6 – Forms & Procedures.
Contact Person for Technical Queries (Copy of the query to be marked to Contracts Dept.)	Mr. Gaurav Kapoor AM (Technical) (gkapoor@eesl.co.in) Mr. Rajneesh Rana GM (Solar) (rana@eesl.co.in)
Contact Person(s) for Tender-related Queries	Mr. Deepak Mittal, Officer (SCM) (dmittal@eesl.co.in) Mr. Yogesh Gujar, AGM (SCM) (ygujar@eesl.co.in)
RfP to be addressed to	CGM (SCM), Energy Efficiency Services Limited,

Other Terms and Condition:

1.0 All the bids must be accompanied by the Bidding Document Cost and the EMD, as mentioned above. **Bids not accompanied by the Bidding Document Cost and EMD, or those accompanied by these instruments of inadequate value, shall not be entertained and in such cases, the bids shall not be opened.**

The Bidding Document Cost has to be necessarily submitted in the form of Demand Draft (DD)/Pay Order/Banker's Cheque in favor of "Energy Efficiency Services Limited", issued by any scheduled/nationalized bank and payable at NOIDA/New Delhi.

The EMD could, at the bidder's option, be in the form of a Pay Order / Banker's Cheque/DD in favour of "Energy Efficiency Services Limited" payable at NOIDA/New Delhi or in the form of a Bank Guarantee (BG) **strictly** as per format at Attachment-2 in Section-6. The BG must be issued only by any of the banks named in Annexure-I of the Attachment-2. The EMD must remain valid for a duration of 45 days beyond the original bid validity duration of 180 days, i.e., 225 days from date of techno-commercial bid opening. If any extension in bid validity is sought by EESL, the bidder may be asked to extend the validity of EMD, which the bidder shall have to do without any cost implications to EESL.

The Bidding Document Cost and the EMD must reach the following address in a sealed envelope superscribed "**EMD and Bidding Document Fee for NIT/Bid Document No. EESL/06/2019-20/KUSUM/SWPS /Phase-1/Off Grid//192007012**" before the submission date & time mentioned above.

CGM (SCM),
Energy Efficiency Services Limited,
Core-3, 6th Floor,
SCOPE Complex,
Lodhi Road, New Delhi-110003

NIT/Bid Document No.: EESL/06/2019-20/KUSUM/SWPS /Phase-1/Off
Grid//192007012

Signature :-
User : CN=DEEPAK MITTAL, ST=DELHI, OID.2.5.4.17=110003, OU=CONTRACTS AN
PROCUREMENT, O=ENERGY EFFICIENCY SERVICES LIMITED, C=IN
User ID : deepak.mittal
Serial No : F3FA77

SECTION-1 (IFB)

Page 3 of 5





The details of the instruments of Bidding Document Cost and the EMD (DD/BG, etc. as applicable) have to be entered online in relevant fields/columns of the module while submitting the E-bid. It must be ensured by the bidder that the original instruments towards Bidding Document Cost and EMD are received by EESL before opening time of the techno-commercial bids for verification of the details of the same as given online by the bidder. Failure to comply with this would render the bid liable for rejection and the bid will not be opened online. EESL will not be responsible for any delay, loss or non-receipt of Bidding/RfP Document Cost or EMD sent by post/courier.

Any relaxation/exemption sought by bidders in accordance with Clause no. 2.4 of Section-2 (ITB) regarding submission of EMD shall only be considered from NSIC Single Point Registered firms and shall be subject to fulfilment of conditions defined in the said Clause. Since all the conditions explained in the said Clause for seeking exemption from submission of Bidding Document Cost and EMD are self-explanatory, bidders should ascertain about their fulfilment of all conditions and submit their bid accordingly. If at any stage, it is found that false information is furnished or non-compliance of any of the conditions defined at the said Clause, the bid/offer shall be considered as non-responsive and would not be considered for further evaluation. Bidder seeking exemption from submission of the Bidding Document Cost and the EMD has to mandatorily submit/upload the scanned copy of their valid original NSIC certificate along with other relevant documents as part of their online bid. Please note that no part exemption is allowed.

2.0 EESL reserves the right to cancel / withdraw the IFB without assigning any reason whatsoever and in such a case, no bidder / intending bidder shall have any claim arising out of such action.

3.0 The subject procurement will be done through e-tendering. The NIT is available on the website <https://eesl.eproc.in> or could be viewed after following the link of 'e-Tendering' on EESL's website's Home Page, i.e., <http://eeslindia.org> from where the bidders registered with EESL (registration process is explained at the Home Page) will be able to download the Tender documents and submit their bids online. The Tender submission, Tender closing and opening will be done electronically and online. Tender information is also available on <https://eprocure.gov.in>

4.0 For start-up firms, regarding the Qualifying Requirements, Gazette Notification dtd. 17-Feb-2016, G.S.R. 180 (E) and subsequent guidelines will be considered.

5.0 EESL reserves the right of reverse bidding on the prospective L-1 price in each Package. In case the discovered L-1 price of any Package is higher than the EESL-estimated cost or higher than the prevailing market price, EESL at its own discretion may go for reverse auctioning among the 60% of participant bidders of that Package in the order of L-1, L-2,..., L-7, subject to a maximum seven nos. of bidders.

NOTE: EESL has appointed M/s. C1 India Pvt. Ltd., NOIDA as implementation agency for carrying out e-Procurement. Also, as per IT ACT 2000, use of Digital Signature Certificate (DSC) is mandatory for participating in the E-tendering process. New bidders should register on the website <https://eesl.eproc.in> by payment of one-time registration fee of Rs. 5,000/- through DD in favor of "Energy Efficiency Services Limited".

Bidders are requested to visit "e-Tendering" section at EESL website, www.eeslindia.org for instructions and registration on E-tendering portal.

Steps for Registration on EESL's E-Procurement Portal

- (i) Open portal by entering URL <https://eesl.eproc.in> in internet explorer.
- (ii) Download and read 'System Requirement Manual' and Registration Manual from our e-tendering portal <https://eesl.eproc.in>
- (iii) Click on 'Login/Sign Up' link and then Registration link for new registration.
- (iv) Fill all mandatory fields and click on submit button.
- (v) Login with the user id and password you have created. You will be redirected to a page where you have to enter your challenge phrase which is received in your registered email id.
- (vi) Register your class-III Signing and Encryption Digital Signature Certificate (DSC).

NIT/Bid Document No.: EESL/06/2019-20/KUSUM/SWPS /Phase-1/Off

Grid/1920070

Signature :
Procurement : CN=DEEPAK MITTAL, ST=DELHI, OID.2.5.4.17=110003, OU=CONTRACTS AND
PROCUREMENT, O=ENERGY EFFICIENCY SERVICES LIMITED, C=IN
User ID : deepak.mittal
Serial No : F3FA77

SECTION-1 (IFB)

Page 4 of 5





- (vii) Fill all mandatory fields of Common Info form and upload scan copy of your DD (in favour of "Energy Efficiency Services Limited", Noida) in PDF format of INR 5,000/- and click on save and send the original DD to EESL, Noida office, Covering Letter on your letter head pad and print out of page regarding registration of approval (automatically generated on screen).
- (viii) Also read the instructions given under E-tendering link available at home page of EESL website www.eeslindia.org.

Note: Online registration shall be done on e-tendering website, i.e., <https://eesl.eproc.in> & in general, activation of registration may take 24 hours subject to the submission of original DD. It is sole responsibility of the bidder to register in advance.

A. Digital Signature Certificate:

It is mandatory for all the bidders to have class-III Digital Signature Certificate (DSC) with signing and Encryption certificate (in the name of person who will sign the BID) from any of the licensed Certifying Agency (Bidders can see the list of licensed CAs from the link www.cca.gov.in) to participate in e-tendering of EESL.

B. EESL Global Support Telephones and e-mail id

Contact Details: +91-124-4302033/36/37, +91-8826814007
eeslsupport@c1india.com, sandeep.bhandari@c1india.com

NIT/Bid Document No.: EESL/06/2019-20/KUSUM/SWPS /Phase-1/Off

Grid/192007042

Signature :-
Proc : CN=DEEPAK MITTAL, ST=DELHI, OID.2.5.4.17=110003, OU=CONTRACTS AN
PROCUREMENT, O=ENERGY EFFICIENCY SERVICES LIMITED, C=IN
User ID : deepak.mittal
Serial No : F3FA77

SECTION-1 (IFB)

Page 5 of 5



SECTION-2

INSTRUCTIONS TO THE BIDDER (ITB) / CONSORTIUM OF BIDDERS

Topics	Page No.
<u>A. The Bidding Documents</u>	05
<u>1 The bidding documents includes the following</u>	05
<u>Definitions</u>	05
<u>Interpretations</u>	07
<u>1.2 Clarification on Bidding Documents</u>	07
<u>1.3 Amendment to bidding documents</u>	08
<u>1.4 Cost of tender Documents</u>	08
<u>B. Preparation of Bids</u>	09
<u>2.1 Procedure for Submission of Bid/RfP.</u>	09
<u>2.2 Cost of Bid/ RfP</u>	10
<u>2.3 Language of Bids</u>	10
<u>2.4 Bid Security/Earnest Money Deposit (EMD) as attachment 2 in First Envelope:</u>	11
<u>2.5 Power of Attorney</u>	11
<u>2.6 Certificate regarding Acceptance of Important Conditions</u>	12
<u>2.7 Deviations.</u>	12
<u>2.8 Bid prices</u>	12
<u>2.9 Price Basis</u>	12
<u>2.10 Period of Validity of Bid</u>	13
<u>2.11 Format and Signing of Bid</u>	13
<u>2.12 Contents of the RfP/Bid</u>	13
<u>2.13 Conflict of Interest</u>	13
<u>2.14 Disclaimer</u>	14
<u>2.15 Authorized Signatory (Bidder or Consortium of bidders)</u>	14
<u>2.16 Consortium related conditions</u>	14
<u>2.17 Contact details of the Bidder or Consortium of bidders</u>	14
<u>2.18 Inspection / Checking / Testing</u>	14
<u>2.19 Removal of Rejected Goods and Replacement</u>	14

Signature :
Subject : CN=DEEPAK MITTAL, ST=DELHI, OID.2.5.4.17=110003, OU=CONTRACTS AN
PROCUREMENT, O=ENERGY EFFICIENCY SERVICES LIMITED, C=IN
User ID : deepak.mittal
Serial No. : 13437

<u>2.20 Access to Bidders Premises</u>	15
<u>2.21 Taxes, Levies and Duties</u>	15
<u>2.22 Terms of Payment</u>	15
<u>2.23 Delivery Schedule</u>	15
<u>2.24 Source of Supply</u>	15
<u>2.25 Patent Indemnity</u>	15
<u>2.26. Force Majeure</u>	16
<u>2.27 Limitation of Liability</u>	16
<u>C. Submission of Bids</u>	16
<u>3.1 Sealing and Marking of Bids</u>	16
<u>3.2 Deadline for submission of bids</u>	16
<u>3.3 Late Bids:</u>	17
<u>D Bid Opening and Evaluation</u>	17
<u>4.1 Bid Opening Process</u>	17
<u>4.2 Clarification on Bids</u>	17
<u>4.3 Preliminary Examination of Bids.</u>	17
<u>4.4 Arithmetical errors rectification process</u>	17
<u>4.5 Preliminary Evaluation</u>	17
<u>4.6 Acceptance of Important Condition</u>	18
<u>4.7 Technical Evaluation</u>	18
<u>4.8 Commercial Evaluation</u>	19
<u>4.9 Evaluations of Deviations:</u>	19
<u>a) Technical and Commercial Deviations</u>	20
<u>b) Time schedule (program of performance)</u>	20
<u>c) Functional Guarantees of the facilities</u>	20
<u>d) Work, services, facilities etc., to be provided by the EESL</u>	20
<u>4.10 Illustrative Method of Evaluation</u>	20
<u>4.11 Contacting the Employer</u>	20
<u>E Award of Contract</u>	21
<u>5.1 Post qualification</u>	21
<u>5.2 Award criteria.</u>	21

Signature :-
Subject : CN=DEEPAK MITTAL, ST=DELHI, OID.2.5.4.17=110003, OU=CONTRACTS AN
PROCUREMENT, O=ENERGY EFFICIENCY SERVICES LIMITED, C=IN
User ID : deepak.mittal
Serial No : 13443

<u>5.3 Quantity Variation</u>	22
<u>5.4 Additions / Alterations / Modifications</u>	22
<u>5.5 EESL's right to accept any bid and to reject any or all bids</u>	22
<u>5.6 Letter of Intent / Letter of Award</u>	22
<u>5.7 Cancellation</u>	22
<u>5.8 Modifications</u>	22
<u>5.9 Performance security</u>	23
<u>5.10 Corrupt or Fraudulent practices:</u>	23
<u>5.11 Ineligibility for Future Tenders</u>	23
<u>6.0 Liquidated Damages</u>	24
<u>7.0 Governing Law</u>	24
<u>8.0 Tax and Duties</u>	24
<u>9.0 Completion Time Guarantee:</u>	25
<u>10.0 Defect Liability</u>	25
<u>11.0 Functional Guarantees</u>	26
<u>12.0 Inspections and Tests</u>	26
<u>13.0 Insurance</u>	27
<u>14.0 Transportation, Demurrage Wharfage, Etc.</u>	27
<u>15.0 Warranty</u>	27
<u>16.0 Termination for Default</u>	28
<u>17.0. Settlement of Disputes</u>	28
<u>18.0 MSME Bidder</u>	29
<u>19.0 Third-Party Consultancy Services</u>	30
<u>20.0 Scope of Services</u>	30
<u>20.1 Standard and Special Services</u>	30
<u>20.2 Due Diligence</u>	30
<u>20.3 Reporting</u>	30
<u>20.4 Staffing</u>	30
<u>20.5 Contact Person of the Consultant</u>	31
<u>21.0 Independence of the Consultant</u>	31
<u>22.0 Commencement and Completion</u>	31
<u>23.0 Force Majeure</u>	31

Signature
Subject : CN=DEEPAK MITTAL, ST=DELHI, OID.2.5.4.17=110003, OU=CONTRACTS AN
PROCUREMENT, O=ENERGY EFFICIENCY SERVICES LIMITED, C=IN
User ID : deepak.mittal
Serial No : 131437

<u>24.0 Suspensions or Termination</u>	32
<u>25.0 Remuneration of the Consultant</u>	32
<u>26.0 Terms of Payment</u>	32
<u>27.0 Method of Payment</u>	32
<u>28.0 Insurance against Liability and Damages</u>	32
<u>LIST OF ACRONYMS</u>	32

Signature :-
Subject : CN=DEEPAK MITTAL, ST=DELHI, OID.2.5.4.17=110003, OU=CONTRACTS AND
PROCUREMENT, O=ENERGY EFFICIENCY SERVICES LIMITED, C=IN
User ID : deepak.mittal
Serial No. : 130433

SECTION-2

INSTRUCTIONS TO THE BIDDER (ITB) / CONSORTIUM OF BIDDERS

Name of the Work: Design, Manufacture, Supply, Transport, Installation, Testing and Commissioning of approximate 1,75,000 numbers of Off Grid Solar Photovoltaic Water Pumping Systems in selected States on PAN India basis, including complete system warranty and its repair and maintenance for 5 Years under MNRE off-grid and decentralized solar PV applications scheme on behalf of State Nodal Agencies (SNAs).

NIT/Bid Document No.: EESL/06/2019-20/KUSUM/SWPS /Phase-1/Off Grid//192007012

Dated: - 21.08.2019

A. The Bidding Documents

1.1 The bidding documents include the following

Section-1	Invitation for Bids (IFB)
Section-2	Instructions to Bidder / Consortium of Bidders
Section-3	General Conditions of Contract
Section-4	Special Conditions of Contract explaining in detail technical specifications, scope of work for supply/supply and installation & Commissioning/Consultancy, drawings, documents in support of bidder's qualifications (Qualifying Requirement), and Online Price Bid format.
Section-5	Measurements and Verification
Section-6	Forms & Procedure Format of Bid Form. Format for submitting BG format in lieu of EMD. Format for Power of Attorney. Format for Certificate regarding acceptance of important terms and conditions. Format for Deviations Statement. Format for submission of Contract Performance Guarantee (CPG). Form of acceptance of Fraud Prevention Policy. Format for submitting BG for Advance Payment, wherever applicable. Format for RTGS/NEFT payments. Format for Declaration of quantity.

The bidder is expected to examine all the instructions, forms, terms, specifications and other information in the bidding documents. Failure to furnish all information required by the bidding documents or submission of a bid not substantially responsive to the bidding documents in every respect will be at the bidder's risk and may result in rejection of bid.

Definitions

In the "Bid / Tender / Contract Document" as herein defined where the context so admits, the following words and expression will have the following meaning:

1. "Affiliate" shall mean a company that either directly or indirectly
 - i) controls or
 - ii) is controlled by or
 - iii) is under common control with

a Bidding Company (in the case of a single company) and "control" means ownership by one company

2. "B.I.S" shall mean specifications of Bureau of Indian Standards (BIS);
3. "Bid / Tender" shall mean the Techno Commercial and the Price Bid submitted by the Bidder along with all documents/credentials/attachments, formats, etc., in response to this Bid Document, in accordance with the terms and conditions hereof.
4. "Bidder / Tenderer" shall mean Bidding Company submitting the Bid. Any reference to the Bidder includes Bidding Company including its successors, executors and permitted assigns jointly and severally, as the context may require";
5. "Bid Security" shall mean the unconditional and irrevocable bank guarantee/ demand draft to be submitted along with the Bid by the Bidder under ITB Clause 2.4 of this Bid;

Subject: CN=DEEPAK MITTAL, OU=DELHI, OID.2.5.4.217=110403, OU=CONTRACTS AN
PROCUREMENT, O=ENERGY EFFICIENCY SERVICES LIMITED, C=IN
User ID : deepak.mittal
Serial No. : 33437

6. "Bidding Company" shall refer to such single/consortium company that has submitted the Bid in accordance with the provisions of this Bid;
7. "Bid Deadline" shall mean the last date and time for submission of Bid in response to this Bid as specified in Bid information Sheet and as specified in ITB Clause 3.2 of this Bid document including all amendments thereto;
8. "Bid Document" shall mean all Definitions, Sections, Layouts, Drawings, Photographs, Formats & Annexures etc. as provided in this bid including all the terms and conditions hereof.
9. "Chartered Accountant" shall mean a person practicing in India or a firm whereof all the partners practicing in India as a Chartered Accountant(s) within the meaning of the Chartered Accountants Act, 1949;
10. "Competent Authority" shall mean Managing Director (MD) of EESL himself and/or a person or group of persons nominated by MD for the mentioned purpose herein;
11. "Company" shall mean a body incorporated in India under the Companies Act, 1956;
12. "Contract" means the agreement entered into between the Employer and the Contractor, as recorded in the Contract Form signed by the parties, including all the attachments and appendices thereto and all documents incorporated by reference therein;
13. "Contract Price / Contract Value" shall mean the sum accepted or the sum calculated in accordance with the prices accepted in Bid and/or the Contract rates as payable to the Contractor for the entire execution and full completion of the Work (Price for Supply, Transportation(including loading, unloading and transfer to Site), Insurance including change order.
14. "Completion of Work" means that the Project/Works have been completed operationally and structurally and Commissioning has been attained as per Technical Specifications.
15. "Commissioning" means successful operation of the Project/Works by the Contractor, for the purpose of carrying out Guarantee Test(s).
16. "Contract Document" shall mean collectively the Bid Document, Design, Drawings, and Specifications, Annexures, agreed variations, if any, and such other documents consisting the bid and acceptance thereof;
17. "Contractor's Equipment" means all plant, Works, equipment, machinery, tools, apparatus, appliances or things of every kind required in or for installation, completion and maintenance of Works that are to be provided by the Contractor, but does not include plant and equipment, or other things intended to form or forming part of the Works.
18. "Day" means calendar day;
19. "Defect Liability Period" means the period of validity of the warranties given by the Contractor (commencing at Completion of the Project/Works, during which the Contractor is responsible for defects with respect to the Project/Works.
20. "Employer" or "EESL" shall mean Energy Efficiency services Limited, New Delhi.
21. "Eligibility Criteria" shall mean the Eligibility Criteria as set forth in Section 3: Technical & Special Conditions of Contract of this BID;
22. "Engineer-in-Charge" shall mean the person designated from time to time by the Employer and shall include those who are expressly authorized by him to act for and on his behalf for operation of this Contract;
23. "Effective Date" means the date from which the Time for Completion shall be determined;
24. "GCC" means the General Conditions of Contract contained in this section;
25. "GHI" shall mean Global Horizontal Irradiation.
26. "Goods" means permanent plant, equipment, machinery, apparatus, articles and things of all kinds to be provided and incorporated in the Works by the Contractor under the Contract but does not include Contractor's Equipment;.
27. "Guarantee Test(s)" means the test(s) specified in the Technical Specification to be carried out to ascertain whether the Project/Works is able to attain the functional requirements specified in the Technical Specifications.
28. "The Government" means the Government of India.
29. "IEC" shall mean specifications of International Electro-technical Commission;
30. "EESL" shall mean Energy Efficiency Services Limited;
31. "Mobilization" shall mean establishment of adequate infrastructure by the Contractor at Site comprising of construction equipment's, aids, tools tackles, offices with facilities such as power, water, communication etc. including manpower comprising of Engineers, Supervising personnel and an adequate strength of skilled, semi-skilled and un-skilled workers, who with the so established infrastructure shall be in a position to commence execution of Work at site(s), in accordance with the agreed Time Schedule of Completion of Work.
32. "O&M/ AMC" shall mean Operation & Maintenance(O& M)/ Annual Maintenance

Signature :
 Subject : CN=DEEPAK MITTAL, ST=DELHI, OID.2.5.4.17=110003, OU=CONTRACTS AN
 PROCUREMENT, O=ENERGY EFFICIENCY SERVICES LIMITED, C=IN
 User ID : deepak.mittal
 Serial No. : 33437

- Contract (AMC) of the supplied equipments;
33. "Parent Company" shall mean a company that holds paid-up equity capital directly or indirectly in the Bidding Company, as the case may be;
 34. "Price Bid" shall mean separate Envelope, containing the Bidder's Quoted Price as per the format prescribed in Section-4 (Technical & Special Conditions of Contract) of this BID;
 35. "Qualified Bidder" shall mean the Bidder(s) who, after evaluation of their Techno Commercial Bid as per Eligibility Criteria set forth in Section 3: Technical & Special Conditions of Contract of this BID stand qualified for opening and evaluation of their Price Bid;
 36. "SNA" shall mean State Nodal Agency.
 37. "SCC" means the Special Conditions of Contract.
 38. "Statutory Auditor" shall mean the auditor of a Company appointed under the provisions of the Companies Act, 1956 or under the provisions of any other applicable governing law;
 39. "Services" means all those services ancillary to the supply of the Works, to be provided by the Contractor under the Contract; e.g. transportation(including loading, unloading and transfer to Site) and provision of marine or other similar insurance, inspection, expediting, Site preparation works (including the provision and use of Contractor's Equipment and the supply of all civil, structural and construction materials required), installation, /Pre-commissioning, commissioning, carrying out guarantee tests, operations, maintenance, the provision of operations and maintenance manuals, training of Employer's personnel and one or two persons from the beneficiaries groups are imparted trainings etc.
 40. "Successful Bidder(s) / Contractor(s)" shall mean the Bidder(s) selected by Employer pursuant to this Bid i.e. on whom award is made. They are also called as implementing partner which includes Consultants also.
 41. "Site" means the Land and other places upon which the Works are to be installed, and such other land or places as may be specified in the Contract as forming part of the Site. The details of the Site are as contained in Section 3: Technical & Special Conditions of Contract of this BID.
 42. "Sub-Contractor" means any person or firm or Company (other than the Contractor) to whom any part of the Work has been entrusted by the Contractor, with the written consent of the Engineer-in-Charge, and the legal representatives, successors and permitted assigns of such person, firm or company.
 43. "Standards" shall mean the standards mentioned in the technical specification of the goods and equipment utilized for the Work or such other standard which ensure equal or higher quality and such standards shall be latest issued by the concerned institution like Bureau of Indian standards(BIS), MNRE, etc.
 44. "Time for Completion" means the time within which Completion of the Project/Works is to be attained in accordance with the stipulations in the SCC and the relevant provisions of the Contract;
 45. "Work" means the "Goods" to be supplied and installed, as well as all the "Services" to be carried out by the Contractor under the Contract;
 46. "Wp" shall mean Watt Peak.
 47. Third Parties means to which employer has awarded some work and consultant may be required to co-ordinate with third parties as per scope of work.
 48. Agreed Remuneration means the fee to which consultant is entitled as per their quoted and agreed price according to the contract.
 49. Consultant: The consultant shall be the professional undertaking or the professional individual named in the contract who is appointed by the employer to perform the services.

Interpretations

1. Words comprising the singular shall include the plural & vice versa
2. An applicable law shall be construed as reference to such applicable law including its amendments or re-enactments from time to time.
3. A time of day shall save as otherwise provided in any agreement or document be construed as a reference to Indian Standard Time.
4. Different parts of this contract are to be taken as mutually explanatory and supplementary to each other and if there is any differentiation between or among the parts of this contract, they shall be interpreted in a harmonious manner so as to give effect to each part.
5. The table of contents and any headings or sub headings in the contract has been inserted for case of reference only & shall not affect the interpretation of this agreement.

1.2 Clarification on Bidding Documents

Signature :-
 Subject : CN=DEEPAK MITTAL, ST=DELHI, OID.2.5.4.17=110003, OU=CONTRACTS AND
 PROCUREMENT, O=ENERGY EFFICIENCY SERVICES LIMITED, C=IN
 User ID : deepak.mittal
 Serial No. : 33437

A prospective Bidder requiring any clarification to the bidding documents may notify the EESL in writing or by post or by telex or telefax) at the EESL's mailing address indicated below. The EESL will respond in writing to any request for clarification or modification of the bidding documents that it receives no later than ten (10) days prior to the deadline for submission of bids prescribed by the EESL. Written copies of the EESL's response (including an explanation of the query but not identification of its source) will be sent to all prospective Bidders that have received the bidding documents.

The address of EESL, for communication:

CGM (SCM),
Energy Efficiency Services Limited,
Core-3, 6th Floor,
SCOPE Complex,
Lodhi Road, New Delhi-110003

The Bidder is advised to visit and examine the site where the facilities are to be installed and its surroundings and obtain for itself on its own responsibility all information that may be necessary for preparing the bid and entering into a contract for supply and installation of the facilities. The costs of visiting the site shall be borne by the bidder fully.

EESL will also facilitate the bidder and any of its personnel or agents for getting permission from the authorities, where actual work is to be executed, to enter upon its premises and lands for the purpose of such inspection, but only upon the express condition that the Bidder, its personnel and agents will release and indemnify the EESL and also the authorities, where work is to be executed, and its personnel and agents from and against all liability in respect thereof and will be responsible for death or personal injury, loss of or damage to property and any other loss, damage, costs and expenses incurred as a result of the inspection.

Whenever the bidder is silent about the acceptance of RfP/IFB conditions such as bank guarantee, warranty period, liquidated damages, certification of relation clause no.2.13 [Conflict of Interest] etc. it shall be presumed that the bidder has accepted and certified RfP/IFB conditions and no further correspondence seeking specific confirmation about acceptance of these conditions shall be made.

The Bidder shall be deemed to have examined the Bid document, to have obtained his own information in all matters whatsoever that might affect carrying out the Works in line with the Technical specifications and Scope of Work specified in the document at the offered rates and to have satisfied himself to the sufficiency of his Bid. The bidder shall be deemed to know the scope, nature and magnitude of the work and requirement of materials, equipment, tools and labour involved, local and national wage structures and as to what all works he has to complete in accordance with the Bid documents irrespective of any defects, omissions or errors that may be found in the Bid documents

1.3 Amendment to bidding documents

At any time prior to the deadline for submission of bids, the EESL may, for any reason, whether at its own initiative, or in response to a clarification requested by a prospective Bidder, amend the bidding documents.

The amendment will be notified in writing or by cable to all prospective bidders who have purchased the bidding documents and will be binding on them. Bidders are required to immediately acknowledge receipt of any such amendment, and it will be assumed that the information contained therein have been taken into account by the Bidder in its bid.

In order to afford prospective Bidders reasonable time in which to take the amendment into account in preparing their bid, the EESL may, at its discretion, extend the deadline for the submission of bids.

1.4 Cost of tender Documents

Interested bidder/consortium of bidders may download the RfP/ Tender documents from the website www.eeslindia.org or may purchase the detailed RfP from the EESL office, address of which is given above at 1.2, between 0900 hrs. and 1730 hrs. on working days on payment of amount as mentioned in Section-1. The payment would be accepted in the form of crossed Demand Draft (DD)/Pay

Signature :
Subject : CN=DEEPAK MITTAL, ST=DELHI, OID.2.5.4.17=110003, OU=CONTRACTS AND
PROCUREMENT, O=ENERGY EFFICIENCY SERVICES LIMITED, C=IN
User ID : deepak.mittal
Serial No : 131477

Order/Banker's Cheque, drawn from any Scheduled Bank, payable at par at NOIDA, in favour of "Energy Efficiency Services Limited".

While submitting the bid (in case tender documents are downloaded from EESL website), bidder shall submit Tender Document Cost as mentioned in Section-1 in the form of DD/Pay Order/Banker's Cheque in favour of "Energy Efficiency Services Limited" payable at NOIDA along with the bid. However bidders who directly purchase the tender documents from EESL can do so by payment of requisite bid document fee at EESL office in the form of DD/Pay order or Banker's Cheque.

B. Preparation of Bids

2.1 Procedure for Submission of Bid/RfP.

Single Stage Single Envelope Bidding Process:

The Bidder or Consortium of bidders should submit hard copy of the offer, i.e. Techno Commercial and Price Bid together in a single sealed envelope superscripted with Bid/RfP number and date, content of envelope, name of work and Bid opening date. Bid-Form, Power of Attorney, Certificate regarding acceptance of important terms and conditions, Deviations Statement, Form of acceptance of Fraud Prevention Policy, etc. as per format defined in Section-6 (Forms & Procedures) shall also be submitted in the same envelope.

Single Stage Two Envelope Bidding Process:

The Bidder shall seal the proposal in one outer and two inner envelopes labeled as Envelope-I and Envelope-II. Two Envelopes should contain the details of the offer as follows:

Envelope-I should contain (This envelope appear ONLINE in dynamic form in case of E-tenders)

- i. Tender Document Cost in the form of DD/Pay Order/Banker's Cheque (wherever applicable).
- ii. Bid Security/Earnest Money Deposit in the form of Banker's Cheque/Demand Draft/Pay order in favor of "Energy Efficiency Services Limited" or in the form of Bank Guarantee as prescribed format as Attachment-2 of Section-6 (Forms & Procedures). **(Only EMD and Bid document fee related document to be submitted by post in sealed envelope superscribed with RfP/Tender reference in case of e-tender).**
- iii. Power of attorney to sign the bid as Attachment-3 of Section-6 (Forms & Procedures). Bidders to use their own format.
- iv. Certificate regarding acceptance of important terms and conditions as per ITB Clause No. 4.6 as Attachment-4 of Section-6 (Forms & Procedures).
- v. Letter of the bidder submitting the bid in the form as stipulated in the bid document, i.e., as per Bid Form as Attachment-1 of Section-6 (Forms & Procedures).
- vi. Deviation statement as per Attachment-5 of Section-6 (Forms & Procedures).
- vii. Form of acceptance of EESL fraud prevention policy as per Attachment-7 of Section-6 (Forms & Procedures).
- viii. Techno-commercial bid as indicated in bid document. Documentary evidence regarding bidder's qualifications to perform the contract as required in qualifying Requirement.

Envelope-II should contain Price Bid, to be submitted in 2nd inner sealed envelope, shall comprise of: (In case of E-tender Price bid is to be submitted ONLINE)

- i. Price Bid in the format prescribed in the tender document.

The entire two separately sealed envelopes will then be placed in one outer envelope, sealed and marked properly and submitted to the EESL office on or before the deadline for submission of the bid. Every envelope (2 inner and 1 outer) should be super-scribed with Bid/RfP number and date, content of envelope i.e. bid security/price bid etc., name of work and Bid opening date.

Single Stage Three Envelope Bidding Process:

The Bidder shall seal the proposal in one outer and three inner envelopes labeled as Envelope-I, Envelope-II and Envelope-III. Three Envelopes should contain the details of the offer as follows:

Envelope-I should contain (This envelope appear ONLINE in dynamic form in case of E-tenders).

Signature :
Subject : CN=DEEPAK MITTAL, ST=DELHI, OID.2.5.4.17=110003, OU=CONTRACTS AN
PROCUREMENT, O=ENERGY EFFICIENCY SERVICES LIMITED, C=IN
User ID : deepak.mittal
Serial No : 13437

 Bid Document No. EESL/06/2019-20/KUSUM/SWPS /Phase-1/Off
Id//192007012

SECTION - 2 (ITB)

Page 9 of 33

- i. Bid document fee/cost of tender documents inform of DD/Pay order or banker's cheque [wherever applicable].
- ii. Bid Security fees/Earnest Money Deposit in form of Banker's Cheque/Demand Draft/Pay order in favor of "Energy Efficiency Services Limited" or in the form of Bank Guarantee as prescribed format [attachment 2 of section - 6, Forms & Procedure]. **(Only EMD and Bid document fee related document to be submitted by post in sealed envelope superscripted with RfP/Tender reference in case of e-tender)**
- iii. Letter of the bidder submitting the bid in the form as stipulated in the bid document i.e., as per Bid Form as attachment 1 of section - 6, Forms & Procedure.
- iv. Power of attorney to sign the bid as attachment 3 of section - 6, Forms & Procedure. Bidders to use their own format.
- v. Certificate regarding acceptance of important terms and conditions as per ITB clause 4.6 as attachment 4 of section – 6 (Forms & Procedures).
- vi. Form of acceptance of EESL fraud prevention policy as per attachment 7 of section-6 (Forms & Procedures).

Envelope-II i.e. Techno commercial Proposal of the bid, to be submitted in 2nd inner sealed envelope, shall comprise of: (This envelope appear ONLINE in dynamic form in case of e tenders)

- i. Deviation statement as per attachment 5 of section - 6, Forms & Procedures.
- ii. Techno-commercial bid as indicated in bid document. Documentary evidence regarding bidder's qualifications to perform the contract as required in qualifying Requirement.

Envelope-III should contain Price Bid, to be submitted in 3rd inner sealed envelope, shall comprise of: (In case of e tender Price bid is to be submitted ONLINE)

- i. Price Bid in the format prescribed in the tender document.

The entire three separately sealed envelopes will then be placed in one outer envelope, sealed and marked properly and submitted to the EESL office on or before the deadline for submission of the bid. Every envelope (3 inner and 1 outer) should be superscripted with Bid/RfP number and date, content of envelope i.e. bid security/price bid etc , name of work and Bid opening date.

Copy of Bid/RfP should be a complete document and should be bound as a volume separately. The document should be page numbered and appropriately flagged and contain the list of contents with page numbers. The deficiency in documentation may result in the rejection of the Bid. All pages of the bid are to be signed by the authorized signatory (authorized through power of attorney) and must be having official seal of the bidder.

Bids not accompanied by cost of tender documents/ Bid Security Fees or EMD etc. shall be out-rightly rejected and treated as non-responsive. Further, their price-bid will be not be opened. For tenders received in unsealed/unstapled/open condition or without any superscription, resulting in opening of tender before due date, the risk and responsibility of losing confidentiality shall rest with the tenderer (applicable for manual tender only)

2.2 Cost of Bid/ RfP

The Bidder or Consortium of bidders shall bear all costs associated with the preparation and submission of its Bid/RfP, including cost of presentation for the purposes of clarification of the bid, if so desired by the EESL. EESL will in no case be responsible or liable for those costs, regardless of the conduct or outcome of the tendering process.

2.3 Language of Bids

The proposal prepared by the bidder/consortium of bidders and all correspondence and documents relating to the Bid/RfP exchanged by the bidder/consortium of bidders and EESL, shall be written in English language, provided that any printed literature furnished by the bidder/consortium of bidders may be written in another language so long the same is accompanied by an English translation in which case, for purposes of interpretation of the bid, the English translation shall govern.

Signature :-
Subject : CN=DEEPAK MITTAL, ST=DELHI, OID.2.5.4.17=110003, OU=CONTRACTS AN
PROCUREMENT, O=ENERGY EFFICIENCY SERVICES LIMITED, C=IN
User ID : deepak.mittal
Serial No. : 13437

2.4 Bid Security/Earnest Money Deposit (EMD) (To be submitted Offline before bid submission time)

Amount of Bid Security: Bid Security/Earnest Money deposit as mentioned in Section I is to be submitted.

The bidder shall furnish, as part of its bid, a bid security in a separate envelope (ITB Clause 2.1). The bid security shall, at the bidder's option, be in the form of a Banker's cheque, Demand Draft in favor of "Energy Efficiency Services Limited" or a bank guarantee as per format in section VI. Bid security/EMD shall remain valid for a period of 45 days beyond the original bid validity period. If there is any extension in bid validity period, then EESL may ask the bidder to extend the validity of bid security.

Any bid not accompanied by an acceptable bid security, shall be rejected by EESL as being non-responsive and returned to the bidder without being opened. The bid security of a consortium must be in the name of all the partners in the consortium submitting the bid. If lead partner is mentioned in case of consortium, then bid security can be in the name of lead partner.

The bid securities of unsuccessful bidders will be returned as promptly as possible after the award is made to lowest evaluated technically acceptable bidder.

The bid security of the successful bidder will be returned when the bidder has signed the contract agreement, and has furnished the required performance security.

Please note that:

- (i) All PSUs and Govt. Department may be exempted from Tender Document Fee and EMD for all Tenders of EESL.
- (ii) Vendors registered with NSIC under single point registration scheme certificate may be given exemption from EMD & Tender Document fee for all tenders of EESL subject to following conditions:
 - (a) NSIC Certificate must be valid for 3 months from the date of Bid-Opening,
 - (b) Monetary Limit of Annual Turnover in NSIC certificate should be Greater than or equal to the Annual Turnover required for that particular project.
 - (c) The supply item for which the tendering is done should be mentioned in the list of items attached with NSIC certificate.

The bid security may be forfeited if:

- a) If the bidder withdraws its bid during the period of bid validity as specified in the bid.
- b) If the bidder does not accept computational/arithmetical error correction made by EESL and as explained in "Financial Evaluation" section of the Bid/ RfP document.
- c) If the bidder does not accept assumptions, estimations etc. used for evaluation of bids as specified by EESL in tender documents and revision of his bid accordingly, in case other assumptions are used. If the bidder does not accept the sharing as specified in the bid.
- d) If the Bidder refuses to withdraw, without any cost to the EESL, any deviation not listed in Attachment 5 but found elsewhere in the bid; or
- e) In the case of successful bidder, if the bidder fails within the specified time limit:
 - To sign the contract agreement within 15 days of placement of Lol/Award letter.
 - To furnish the required performance guarantee, in accordance with the tender document.

2.5 Power of Attorney

Power of Attorney as attachment 3 in first envelope: A power of attorney duly authorized by a notary public, indicating that the person(s) signing the bid has/have the authority to sign the bid and thus the bid is binding upon the bidder during the full period of its validity in accordance with ITB clause 2.10.

2.6 Certificate Regarding Acceptance of Important Conditions

Certificate Regarding Acceptance of Important Conditions as attachment 4 is to be submitted in first envelope.

Signature :
Subject : CN=DEEPAK MITTAL, ST=DELHI, OID.2.5.4.17=110003, OU=CONTRACTS AN
PROCUREMENT, O=ENERGY EFFICIENCY SERVICES LIMITED, C=IN
User ID : deepak.mittal
Serial No : 33437

No deviation, other than mentioned in Deviation statement, is permitted by the EESL, to the provisions of the bidding documents listed in ITB sub-clause 4.6. The Bidders are advised that while making their bid proposals and quoting prices, these conditions may appropriately be taken into consideration. Bidders are required to furnish a certificate indicating their compliance to the provisions relating to the clauses listed in ITB sub-clause 4.6 in Attachment 4. Attachment 4 for acceptance of important conditions duly signed and stamped by the bidder is to be furnished in a separate sealed first envelope/Online. Any bid not accompanied by such certificate in a separate sealed first envelope/such certificate Online shall be rejected by the EESL and returned to the Bidder without being opened.

2.7 Deviations,

Deviations, if any, from the terms and conditions of bidding documents or technical specifications shall be listed only in Attachment 5 to the bid. The Bidder shall also provide the additional price, if any, for withdrawal of the deviations. However, the attention of the bidders is drawn to the provisions of ITB sub-clause 4.6 regarding the rejection of bids that are not substantially responsive to the requirements of the bidding documents.

Bidders may further note that except for the deviations listed in Attachment 5, the bid shall be deemed to comply with all the requirement in the bidding documents and the bidders shall be required to comply with all such requirements of bidding documents and technical specifications without any extra cost to the EESL irrespective of any mention to the contrary, anywhere else in the bid, failing which the bid security of the bidder may be forfeited.

At the time of award of contract, if so desired by the EESL, the bidder shall withdraw these deviations listed in Attachment-5 at the cost of withdrawal stated by him in his bid. In case the bidder does not withdraw the deviations proposed by him, if any, at the cost of withdrawal stated in the bid, his bid will be rejected and bid security forfeited.

2.8 Bid prices

Unless otherwise specified in the technical specifications, bidders shall quote for the entire facilities on a "single responsibility" basis such that the total bid price covers all the contractor's obligations mentioned in or to be reasonably inferred from the bidding documents in respect of the design, manufacture, including procurement and subcontracting (if any), delivery, construction, installation, survey cost, monitoring and verification cost and completion of the facilities including supply of mandatory spares or spares to be supplied during warranty (if any). This includes all requirements under the contractor's responsibilities for testing, pre -commissioning and commissioning of the facilities and, where so required by the bidding documents, the acquisition of all permits, approvals and licenses, etc.; the operation, maintenance and training services and such other items and services as may be specified in the bidding documents, all in accordance with the requirements of the General Conditions of Contract and Technical Specification.

Bidders are required to quote the price for the commercial, contractual and technical obligations outlined in the bidding documents. If a Bidder wishes to make a deviation to the provisions of the bidding documents, such deviations shall be listed in Attachment 5 of its bid. The bidder shall also provide the additional price, if any, for withdrawal of the deviations, pursuant to ITB sub-clause 2.7.

Bidders shall give a breakdown of the prices in the manner and detail called for in the price schedules.

2.9 Price Basis

Price basis of the price quoted shall be on F.O.R (Free on Road) destination basis for site. Price mentioned in the quotation must be firm. Hence prices in Letter of Award shall be firm and not subject to escalation till the execution of the complete order and its subsequent amendments accepted by the bidder even though the completion / execution of the order may take longer time than the delivery period specified and accepted in the Letter of Award.

Statutory variation in applicable taxes & duties (other than excise duty) shall only be on account of Employer in case bidder has shown the rates of present taxes in their bid and other prices quoted by the Bidder shall be fixed during the Bidder's performance of the Contract and not subject to

Signature :-
Subject : CN=DEEPAK MITTAL, ST=DELHI, OID.2.5.4.17=110003, OU=CONTRACTS AN
PROCUREMENT, O=ENERGY EFFICIENCY SERVICES LIMITED, C=IN
User ID : deepak.mittal
Serial No : 131437

variation on any account. Even in case prices asked in Bid price Schedule are quoted as inclusive of taxes , tax rates shall be shown separately. Bidders shall quote all prices in Indian Rupees only.

2.10 Period of Validity of Bid

Bids shall remain valid for a period of 90 days after the closing date prescribed by the EESL for the receipt of bids. A bid valid for a shorter period may be rejected by the EESL as being non responsive. In exceptional circumstances, the EESL may solicit the bidder's consent to an extension of the bid validity period. The request and response thereto shall be made in writing thro' letters/ e-mails .If the bidder accepts to prolong the period of validity, the bid security/EMD shall also be suitably extended. A bidder may refuse the request for Bid Validity Extension without forfeiting its bid security. A bidder granting the request will not be required nor permitted to modify its bid.

2.11 Format and Signing of Bid

The original copy of the bid, consisting of the documents listed in ITB sub-clause 1.1 shall be typed or written in indelible ink and shall be signed by the bidder or a person or persons duly authorized to bind the bidder to the contract. The authorization shall be indicated by written power of attorney accompanying the bid and submitted as Attachment 3 to the bid under ITB sub-clause 2.5. All pages of the bid, except for un-amended printed literature, shall be initialed by the person or persons signing the bid.

Any interlineations, erasures or overwriting shall only be valid if they are initialed by the signatory to the bid.

2.12 Contents of the RfP/Bid

The Bidder or consortium of bidders is expected to examine all instructions, forms, terms & conditions and scope of work in the RfP/bid documents. Failure to furnish all information required or submission of an RfP/bid document not substantially responsive to the RfP/bid document in every respect will be at the bidder's risk and may result in the rejection of the RfP/bid.

2.13 Conflict of Interest

EESL's policy requires that a bidder participating in a procurement/contract process under EESL financed projects shall not have a conflict of interest. All bidders found to have a conflict of interest shall be ineligible for award of contract.

A. Bidder may be considered to have a conflict of interest in a bidding process if:

- a) it, or any of its affiliates, has been engaged by EESL to provide consulting services for the preparation or implementation of a project, and participates in a bidding to provide goods, works, or non-consulting services resulting from or directly related to such consulting services. Or
- b) it submits more than one bid in a bidding process, either individually or as a partner in a joint venture, except for permitted alternative bids. This will result in the disqualification of all bids in which the bidder is involved. However, this does not limit the inclusion of a firm as a subcontractor in more than one bid and the participation of a bidder as a subcontractor in another bid in certain types of procurement/contract, if permitted by the EESL's bidding documents; or
- c) it (including its personnel or sub-contractors) has a business or family relationship with a member of a EESL's staff (or of the project implementing staff, or of a recipient of a part of the loan) who: are directly or indirectly involved in the preparation of the bidding documents or specifications of the contract, and/or the bid evaluation process of such contract; or would be involved in the implementation or supervision of such contract unless the authority inviting tenders shall be informed of the fact/ such relationship at the time of submission of the tender and the conflict stemming from such relationship has been resolved in a manner acceptable to the EESL throughout the procurement process and execution of the contract. EESL may in its discretion reject the tender or rescind the contract.; or
- d) it does not comply with any other conditions that may be specified in the Company's Standard Bidding Documents relevant to the specific procurement process.

Signature :-
Subject : CN=DEEPAK MITTAL, ST=DELHI, OID.2.5.4.17=110003, OU=CONTRACTS AN
PROCUREMENT, O=ENERGY EFFICIENCY SERVICES LIMITED, C=IN
User ID : deepak.mittal
Serial No : 131437

2.14 Disclaimer

EESL and/or its officers, employees disclaim all liability from any loss or damage, whether foreseeable or not, suffered by any person acting on or refraining from acting because of any information including statements, information, forecasts, estimates or projections contained in this document or conduct ancillary to it whether or not the loss or damage arises in connection with any omission, negligence, default, lack of care or misrepresentation on the part of EESL and/or any of its officers, employees.

2.15 Authorized Signatory (Bidder or Consortium of bidders)

The bidder or consortium of bidders as used in the RfP/ bid document shall mean the one who has signed the bid/RfP document forms. The bidder or consortium of bidders should be the duly authorized representative of the bidder/consortium of bidders, for which a certificate of authority/power of attorney will be submitted along with the offer. This should clearly define the authority provided to the authorized representative. Complete offer, all certificates and documents (including reply to any clarifications sought and any subsequent correspondences) shall be furnished and signed on all pages by the authorized representative.

The power of attorney or authorization, or any other document consisting of adequate proof of the ability of the signatory to bind the bidder or consortium of bidders shall be annexed to the bid as attachment 3 in envelope 1. EESL may reject outright any proposal not supported by adequate proof of the signatory's authority.

2.16 Consortium related conditions

The bidder shall have the option to submit the proposal either alone or along with other partner companies. Prerequisites for bidder have been specified in qualifying requirement and other parts of the tender document. The lead partner shall be the sole point of contact for all purposes of the Contract. The lead partner will have the prime and sole responsibility for the execution of the scope of work. Any information/clarification submitted to the lead partner by EESL will mean that the same has been conveyed to all partners. However, the partner companies should not be involved in any major litigation that may have an impact of affecting or compromising the delivery of services as required under this contract. The bidder or any of the partner companies should not have been black-listed by any Central / State Government or Public Sector Undertakings. If at any stage of tendering process or during the currency of the contract, any suppression / falsification of such information is brought to the knowledge, EESL shall have the right to reject the proposal or terminate the contract, as the case may be, without any compensation to the tenderer & forfeiture of bid security/EMD/CPG.

2.17 Contact details of the Bidder or Consortium of bidders

Bidder or Consortium of bidders who wants to receive EESL's response to queries should give their contact details to EESL. The Bidder or Consortium of bidders should send their contact details in writing at the EESL's contact address.

2.18 Inspection / Checking / Testing

All materials / equipments manufactured by the bidder/consortium of bidders against the Letter of Award shall be subject to inspection, check and/or test by the EESL or his authorized representative at all stages and place, before, during and after the manufacture. All these tests shall be carried out in the as per technical specifications and bidder shall submit the relevant test reports. If upon delivery the material / equipment does not meet the specification, the materials / equipment shall be rejected and returned to the bidder for repairs / modification etc. or for replacement. In such cases all expenses including the to-and-fro freight, repacking charges, any other costs etc. shall be to the account of the bidder.

2.19 Removal of Rejected Goods and Replacement

If upon delivery, whether inspected and approved earlier or otherwise, the material/equipment is not in conformity with the specification, the same shall be rejected by EESL or duly authorized representative and notification to this effect will be issued to the bidder normally within 7 days from the date of receipt of the material at the work/site/office.

The bidder shall arrange removal of the rejected items within 15 days from the date of notification. In the event, the bidder fails to lift the materials within the said 15 days, EESL shall be at liberty to

Signature
Subject : CN=DEEPAK MITTAL, ST=DELHI, OID.2.5.4.17=110003, OU=CONTRACTS AND
PROCUREMENT, O=ENERGY EFFICIENCY SERVICES LIMITED, C=IN
User ID : deepak.mittal
Serial No : 131437

dispose off such rejected items in any manner as it may deemed fit. All expenses incurred on storage, disposal etc. shall be recoverable from the bidder.

2.20 Access to Bidders Premises

EESL and/or its authorized representative shall be provided access to bidder and/or his sub- bidder's premises, at any time during the pendency of the Order, for expediting, inspection, checking, etc. of work, if it is felt by EESL.

2.21 Taxes, Levies and Duties

Prices of items shall be quoted as per instruction contained in SCC. However, in general, prices shall be inclusive of sales tax, transportation, insurance, levies , service tax and any other duties payable including entry tax/octroy etc, (wherever applicable) on FOR destination/site basis. All taxes and duties shall be clearly indicated. Bidder is to arrange on its own to deliver the material at site. No road permit is provided by EESL.

For hiring of consultant/consultancy work also service tax shall be quoted exclusive of basic price. However, rates of such taxes consider while preparing the offer should invariably be mention in the offer so that any variation in taxes (except excise duty) can be paid as actual.

2.22 Terms of Payment

The payment will be made by EESL to the bidder in accordance with the terms and conditions specified in section 4 of special conditions of contract of tender document/agreed upon during negotiation and reproduced in Letter of Award.

2.23 Delivery Schedule

Time will be the essence of order and no variation shall be permitted in the delivery time/delivery schedule mentioned in the order unless agreed by EESL without levy of LD. Tentative time schedule is enclosed in the RfP/ bid document. Delivery of the equipment/material described shall be deemed to constitute acceptance of this order and terms and conditions by the bidder at the price specified.

2.24 Source of Supply

The bidder shall ensure that the indigenous capacity is utilized to the fullest extent possible in execution of this order. Where the imports are unavoidable, all such items shall be imported by the bidder in time against his own import license without affecting the contractual delivery schedule.

2.25 Patent Indemnity

Royalties and fees for patents covering material/equipment or processes used in executing the work shall be to the account of the bidder. The bidder shall satisfy all demands that may be made at any time for such royalties and fees and he alone shall be liable for damages, infringement and shall keep EESL indemnified in that regard in the event of any equipment/ material or part there of supplied by the bidder is involved in any suit or other proceedings held to constitute infringement and its used is enjoyed, the bidder shall, at his own expenses, either procure for EESL the right to continue the use of such equipment/material replace it with a non-infringing material / equipment or modify it so it become non- infringing.

Tenderer shall agree to indemnify the EESL or/and hold it/them harmless from against all claims, liability, loss, damage or expense including counsel fees arising from or by reasons of an action or claimed trade mark patent or copyright infringement or any litigation based thereon with respect to any part of the quoted items and such obligation shall survive acceptance of and payment for the items.

2.26. Force Majeure

Bidder shall not be considered in default if delay in delivery occurs due to causes beyond his control such as acts of God, natural calamities, civil wars, strikes, fire, frost, floods, riot. Only those causes which have duration of more than 7 days shall be considered cause of force/ calendar majeure. A notification to this effect duly certified by local chamber of commerce/ statutory authorities shall be given by the bidder to EESL by registered/speed post letter. In the event of delay due to such causes,

Signature
Subject : CN=DEEPAK MITTAL, ST=DELHI, OID.2.5.4.17=110003, OU=CONTRACTS AN
PROCUREMENT, O=ENERGY EFFICIENCY SERVICES LIMITED, C=IN
User ID : deepak.mittal
Serial No. : 33433

the delivery schedule will be extended for a length of time equal to the period of force majeure or at the option of EESL, the order may be cancelled. Such cancellation, would be without any liability whatsoever on the part of EESL. In the event of such cancellation, the bidder shall refund any amount advanced or paid to the bidder by EESL and deliver back any materials issued to him by the Purchaser and release facilities, if any provided by the Purchaser.

2.27 Limitation of Liability

Except in cases of criminal negligence or willful misconduct, the Implementing Partner shall not be liable to the EESL, whether in contract, tort, or otherwise, for any indirect or consequential loss or damage, loss of use, loss of production, or loss of profits or interest costs, provided that this exclusion shall not apply to any obligation of the Implementing Partner to pay liquidated damages to the EESL and the aggregate liability of the Implementing Partner to the EESL, whether under the Contract, in tort or otherwise, shall not exceed the total Contract Price, provided that this limitation shall not apply to any obligation of the Implementing Partner to indemnify the EESL with respect to patent infringement or as specified in SCC.

C. Submission of Bids

3.1 Sealing and Marking of Bids

The Bidder shall seal the original copy of the bid in envelope duly marking the envelopes as "ORIGINAL BID". All envelopes must be super-scribed with name of work, RfP No., envelope no., content of envelope and date and bid opening date. The envelopes shall then be sealed in an outer envelope which should also be super scribed with name of work, RfP/ bid document no./package no. and date and bid opening date.

3.2 Deadline for submission of bids

Bids must be received by the EESL at the address specified as under and the bids will be opened at the same address as per timings stated in IFB and as repeated below.

CGM (SCM),
Energy Efficiency Services Limited,
Core-3, 6th Floor,
SCOPE Complex,
Lodhi Road, New Delhi-110003

Date of submission of bids: As mentioned in Section I

Date of bid opening: As mentioned in Section I

Bids must be received at the address specified above but no later than the time and date stated as above. In the event of the specified date for submission of bids being declared a holiday for the EESL, the bids will be received up to the appointed time on the next working day.

The EESL may, at its discretion, extend this deadline for submission of bids by amending the bidding documents in accordance with ITB Sub-Clause 1.3, in which case all rights and obligations of EESL and bidders will thereafter be subject to the deadline as extended.

No bid may be withdrawn in the interval between the bid submission deadline and the expiration of the bid validity period specified in ITB Clause 2.10. Withdrawal of a bid during this interval may result in the bidder's forfeiture of its bid security, pursuant to ITB Sub-Clause 2.4.

3.3 Late Bids:

Any bid received by the EESL after the bid submission deadline prescribed by the EESL, pursuant to ITB Clause 3.1 & 3.2, will be rejected and returned in unopened condition.

D Bid Opening and Evaluation

4.1 Bid Opening Process

The EESL will open all bids in the presence of bidders' representatives who choose to attend the opening at the time, on the date and at the place specified in the NIT. Bidders' representatives shall sign a format as proof of their attendance. In the event of the specified date for the opening of bids

Subject: CN=DEEPAK MITTAL, ST=DELHI, OID.2.5.4.17=110003, OU=CONTRACTS AND
PROCUREMENT, O=ENERGY EFFICIENCY SERVICES LIMITED, C=IN
User ID : deepak.mittal
Serial No. : 13437

 NIT Bid Document No. EESL/06/2019-20/KUSUM/SWPS /Phase-1/Off
Id//192007012

SECTION - 2 (ITB)

Page 16 of 33

being declared a holiday for the EESL, the bids will be opened at the appointed time on the next working day.

Bidders' names, bid prices, discounts, the presence or absence of requisite bid security and other such details as the EESL, at its discretion, may consider appropriate, will be announced at the opening. Late bids pursuant to ITB clause 3.2, and/or bids not accompanied by the "Certificate regarding acceptance of important conditions" as per Attachment-4 in a separate sealed envelope pursuant to ITB sub-clause 2.6, and/or bids not accompanied by requisite bid security in a separate sealed envelope pursuant to ITB clause 2.4, will be rejected and returned unopened to the bidder.

Bids that are not opened and read out at bid opening will not be considered for further evaluation, regardless of the circumstances.

The EESL will prepare minutes of the bid opening.

4.2 Clarification on Bids

During bid evaluation, the EESL may, at its discretion, ask the bidder for a clarification of its bid. The request for clarification and the response shall be in writing, and no change in the price or substance of the bid shall be sought, offered or permitted. The address for communication will be same as ITB clause 1.2.

4.3 Preliminary Examination of Bids.

The EESL will examine the bids to determine whether they are complete, whether any computational errors have been made, whether required sureties have been furnished, whether the documents have been properly signed, and whether the bids are generally in order.

4.4 Arithmetical errors rectification process

Arithmetical errors will be rectified on the following basis. If there is a discrepancy between the unit price and the total price, which is obtained by multiplying the unit price and quantity, or between sub totals and the total price, the unit or subtotal price shall prevail, and the total price shall be corrected. If there is a discrepancy between words and figures, the amount in words will prevail. If the Bidder does not accept the correction of errors, its bid will be rejected and the bid security will be forfeited in accordance with ITB Sub-Clause 2.4.

The EESL may waive any minor informality, nonconformity or irregularity in a bid that does not constitute a material deviation, whether or not identified by the bidder in Attachment 4 to its bid, and that does not prejudice or affect the relative ranking of any bidder as a result of the technical and commercial evaluation, pursuant to ITB clauses 4.7 and 4.8.

4.5 Preliminary Evaluation

Prior to the detailed evaluation, the EESL will determine whether each bid is of acceptable quality, is generally complete and is substantially responsive to the bidding documents. For purposes of this determination, a substantially responsive bid is one that conforms to all the terms, conditions and specifications of the bidding documents without material deviations, objections, conditionality's or reservations. A material deviation, objection, conditionality or reservation is one (i) that affects in any substantial way the scope, quality or performance of the contract; (ii) that limits in any substantial way, inconsistent with the bidding documents, the EESL's rights or the successful bidder's obligations under the contract; or (iii) whose rectification would unfairly affect the competitive position of other bidders who are presenting substantially responsive bids.

4.6 Acceptance of Important Condition

No deviation, whatsoever, is permitted by the EESL to the provisions relating to the following clauses (Important Conditions). Party is to submit the following as attachment 4 in envelope 1:

Governing Laws	-	Clause 7 of ITB
Settlement of Disputes	-	Clause 17 of ITB

Signature
Subject : CN=DEEPAK MITTAL, ST=DELHI, OID.2.5.4.17=110003, OU=CONTRACTS AND
PROCUREMENT, O=ENERGY EFFICIENCY SERVICES LIMITED, C=IN
User ID : deepak.mittal
Serial No. : 131437

Terms of payment	-	Clause 1.0 of SCC
Performance Security	-	Clause 5.9 of ITB
Taxes and Duties	-	Clause 8 of ITB
Completion Time Guarantee	-	Clause 9 of ITB
Defects Liability	-	Clause 10 of ITB
Functional Guarantee	-	Clause 11 of ITB
Patent Indemnity	-	Clause 2.25 of ITB
Limitations of Liability	-	Clause 2.27 of ITB
Project information, Estimation, Assumptions and conditions for Evaluation	-	As per Tables in price bid

Bidders are required to furnish a certificate as per Attachment 4, indicating their compliance to the provisions of the above clauses in a separate sealed envelope. In case the certificate as per Attachment-4 duly signed and stamped by the bidder, is not furnished along with the bid in a separate sealed envelope, the bid shall be rejected and returned to the bidder without being opened

At the time of award of contract, if so desired by the EESL the bidder shall withdraw the deviations listed in attachment 5 at the cost of withdrawal stated by him, in his bid. In case the bidder does not withdraw the deviations proposed by him in attachment 5 to his bid, if any; at the cost of withdrawal stated in his bid, his bid will be rejected and security will be forfeited.

The EESL's determination of a bid's responsiveness is to be based on the contents of the bid itself without recourse to extrinsic evidence. If a bid is not substantially responsive, it will be rejected by the EESL, and may not subsequently be made responsive by the bidder by correction of the nonconformity.

4.7 Technical Evaluation

The EESL will carry out a detailed evaluation of the bids previously determined to be substantially responsive in order to determine whether the technical aspects are in accordance with the requirements set forth in the bidding documents. In order to reach such a determination, the EESL will examine and compare the technical aspects of the bids on the basis of the information supplied by the bidders, taking into account the following factors:

- a) Overall completeness and compliance with the technical specifications and drawings; deviations from the technical specifications as identified in Attachment 5 to the bid; suitability of the facilities offered in relation to the environmental and climatic conditions prevailing at the site; and quality, function and operation of any process control concept included in the bid. The bid that does not meet minimum acceptable standards of completeness, consistency and detail will be rejected for non- responsiveness.
- b) Achievement of specified performance criteria by the facilities as per scope of work
- c) Type, quantity and long-term availability warranty spare parts and also mandatory and recommended spare parts and maintenance services
- d) Any other relevant factors, if any, listed in the tender document, or that the EESL deems necessary or prudent to take into consideration.

4.8 Commercial Evaluation

The comparison shall be of the FOR site price of domestically manufactured plant and equipment including type test charges, if any and mandatory spares, warranty spares plus applicable sales tax &

Signature :-
Subject : CN=DEEPAK MITTAL, ST=DELHI, OID.2.5.4.17=110003, OU=CONTRACTS AN
PROCUREMENT, O=ENERGY EFFICIENCY SERVICES LIMITED, C=IN
User ID : deepak.mittal
Serial No : 33437

duties as well duties and taxes paid/payable on components and raw materials incorporated or to be incorporated in the plant and equipment including mandatory spares/warranty spares plus the cost of loading, unloading, local transportation, insurance covers, installation and commissioning, civil work other services required under the contract including service tax and surcharge, if any plus any survey cost, monitoring and verification cost, distribution cost, scrap disposal cost, annual maintenance cost, any services as per scope of work, administrative charges and statutory agencies cost including service tax and surcharge, if any. The EESL's comparison will also include the costs resulting from application of the evaluation procedures described in ITB sub-clause 4.9. However, the price of recommended spare parts or optional spares or services, if asked in the bid, shall not be considered for evaluation of bids.

The EESL's evaluation of a bid will take into account, in addition to the bid prices indicated in price schedules in section 4 along with the corrections pursuant to ITB sub-clause 4.3, the following costs and factors that will be added to each bidder's bid price in the evaluation using pricing information available to the EESL, in the manner and to the extent indicated in ITB sub-clause 4.9 and in the technical specifications:

- a) The cost of all quantifiable deviations and omissions from the contractual and commercial conditions and the technical specifications as identified in Attachment 5 to the Bid.
- b) Compliance with the time schedule called for and evidenced as needed in a milestone schedule provided in the bid.
- c) The functional guarantees of the facilities offered as per scope of work.
- d) The extra cost of work, services, facilities etc, required to be provided by the EESL of third parties.

4.9 Evaluations of Deviations:

Pursuant to ITB Sub-Clause 4.8, the following evaluation methods will be followed:

a) Technical and Commercial Deviations

The evaluation shall be based on the evaluated cost of fulfilling the contract in compliance with all commercial, contractual and technical obligations under this bidding document. In arriving at the evaluated cost, the price for withdrawal of deviations shown in Attachment 5 to the bid will be used if necessary. If such a price is not given in Attachment-5, the EESL will make its own assessment of the cost of such a deviation for the purpose of ensuring fair comparison of bids.

b) Time schedule (program of performance)

The plant and equipment covered by this bidding are required to be transported/ shipped and installed, and the facilities are to be completed within the period as mentioned below.

Completion of all facilities/work: As per year/months in SSC.

The above date will be the effective date specified in the contract agreement. Bidders are required to base their prices on the time schedule or, where no time schedule is given, on the completion date(s) given above. No credit will be given for earlier completion.

The master network and the key milestone dates will be discussed with the successful bidder and agreed upon in pre-award discussion before issuance of Letter of Award. Engineering drawing and data submission schedule shall also be discussed and finalized before the issuance of Letter of Award.

After the Letter of Award, the contractor shall plan the sequence of work manufacture, supply, installation to meet the above stated dates of successful completion of facilities and shall ensure all work, manufacture, shop testing, inspection and shipment of the equipment in accordance with the required sequence.

c) Functional Guarantees of the facilities

Signature :-
Subject : CN=DEEPAK MITTAL, ST=DELHI, OID.2.5.4.17=110003, OU=CONTRACTS AND
PROCUREMENT, O=ENERGY EFFICIENCY SERVICES LIMITED, C=IN
User ID : deepak.mittal
Serial No : 131437

Bidders shall state the functional guarantees (e.g. performance, efficiency, consumption) of the proposed facilities in response to the technical specifications. In case a minimum (or a maximum, as the case may be) level of functional guarantees is specified in the technical specifications for the bids to be considered responsive, bids offering plant and equipment with such functional guarantees less (or more) than the minimum (or maximum) specified shall be rejected.

d) Work, services, facilities etc., to be provided by the EESL

Where bids include the undertaking of work or the provision of services or facilities by the EESL in excess of the provisions allowed for in the bidding documents, the EESL shall assess the costs of such additional work, services and/or facilities during the duration of the contract. Such costs shall be added to the bid price for evaluation.

4.10 Illustrative Method of Evaluation

	Any Bidder (INR)
1 Quoted bid price without taxes and duties (After considering arithmetical errors)	
i) Ex works including Excise duty price including Type test Charges/Lab Test charges + inland transportation including inland Transit insurance etc. For equipment and spares	N1
ii) Prices for dismantling and/or installation	N2
iii) Prices for additional Warranty, if any	N3
iv) Total Price	N(N1+N2+N3)
2. Taxes and Duties	
i) CST/VAT	T1
ii) Service Tax	T2
iii) Total	T(T1+T2)
3. Cost Compensation	
i) Technical Cost Compensation	TCC
ii) Commercial Cost Compensation	CCC
iii) Total	TCC+CCC
4. Adjustments for Functional Guarantees	X
5. Final Evaluated Bid Price	N+T+TCC+CCC+X

4.11 Contacting the Employer

Subject to ITB Clause 20, no Bidder shall contact the Employer on any matter relating to its bid, from the time of the opening of bids to the time the contract is awarded.

Information relating to the examination, evaluation and comparison of bids and recommendations for the award of contract shall not be disclosed to bidders or any other persons not officially concerned with such process until the award to the successful bidder has been announced. Any effort by a Bidder to influence the Employer in the Employer's bid evaluation, bid comparison or contract award decisions may result in rejection of the Bidder's bid.

E Award of Contract

5.1 Post qualification

In the absence of pre-qualification, the EESL will determine to its satisfaction whether the bidder selected as having submitted the lowest evaluated responsive bid/or bidder giving highest return to EESL, as the case may be, as mentioned in special condition of contract is qualified to satisfactorily perform the contract in terms of the qualifying requirements stipulated in IFB/NIT and section 3.

Subject : CN=DEEPAK MITTAL, ST=DELHI, OID.2.5.4.17=110003, OU=CONTRACTS AN
PROCUREMENT, O=ENERGY EFFICIENCY SERVICES LIMITED, C=IN
User ID : deepak.mittal
Serial No. : 131437

The determination will take into account the bidder's financial, technical and production capabilities, in particular its contract, work in hand, future commitments and current litigation. It will be based upon an examination of the documentary evidence of the bidder's qualifications submitted by the bidder in RfP forms in section IV to the bid, as well as such other information as the EESL deems necessary and appropriate.

An affirmative determination will be a prerequisite for award of the contract to the bidder. A negative determination will result in rejection of the bidder's bid, in which event the EESL will proceed to the next lowest evaluated bid/next bid giving highest return to EESL to make a similar determination of that bidder's capabilities to perform satisfactorily.

The capabilities of the vendors and subcontractors proposed in section 3, if permitted, to the bid to be used by the lowest evaluated bidder or bidder giving highest return to EESL as per SCC will also be evaluated for acceptability. Their participation should be confirmed with a letter of intent between the parties, as needed. Should a vendor or subcontractor be determined to be unacceptable, the bid will not be rejected, but the Bidder will be required to substitute an acceptable vendor or subcontractor without any change to the bid price.

The Employer reserves the right to assess the capacity and capability of the bidder/ his collaborator to satisfactorily execute the contract. Such assessment shall include but not be limited to the evaluation of adequacy of facilities, services, resources, design / engineering capability and financial capability

5.2 Award criteria

Subject to ITB Clause 5.5, the EESL will award the contract to the successful Bidder whose bid has been determined to be substantially responsive and to be the lowest evaluated technically acceptable bid or bid offering highest return to EESL as the case may be as per tender documents and special conditions of contract, further provided that the Bidder is determined to be qualified to perform the contract satisfactorily

Except for the deviations listed in Attachment-5, the bidder would be required to comply with all the requirements of bidding documents without any extra cost to EESL failing which his bid security will be forfeited. Further, the EESL may request the bidder to withdraw any or all of the deviations listed in Attachment – 5 to the winning bid, at the price shown for the deviation in Attachment 5 to the bid. In case the bidder does not withdraw the deviations proposed by him, if any, at the cost of withdrawal stated in the bid, his bid will be rejected and bid security forfeited.

The mode of contracting with the Successful Bidder will be as per stipulation briefly indicated below:

- (i) First Contract: For supply of plant and equipment.
- (ii) Second Contract: For providing all services i.e. inland transportation for delivery at site, inland transit insurance, unloading, storage, handling at site, installation (including civil. Structural steel work & allied work, if applicable) insurance covers other than inland transit insurance, erection, testing & commissioning, conducting Guarantee tests in respect of all the Goods supplied under the 'First Contract' and all other
- (iii) Services as specified in the Contract Documents.

The above Contracts will contain a cross-fall breach clause specifying that breach of one Contract will constitute breach of the other Contract which will confer a right on the Employer to terminate the other Contract also at the risk and the cost of the Contractor

5.3 Quantity Variation

The EESL reserves the right to vary the quantity of any of the spares and maintenance equipment upto +/- 20% and/or delete any items of spares altogether at the time of Award of Contract. Successful bidder, on whom award is made, is to supply this quantity variation at same price and terms and conditions of contract.

Signature :-
Subject : CN=DEEPAK MITTAL, ST=DELHI, OID.2.5.4.17=110003, OU=CONTRACTS AN
PROCUREMENT, O=ENERGY EFFICIENCY SERVICES LIMITED, C=IN
User ID : deepak.mittal
Serial No : 33437

5.4 Additions / Alterations / Modifications

EESL reserves the right to make minor additions/alterations/modifications to the quantity of the items to the extent of +/- 20% in the Letter of Award. The bidder shall supply such quantities also at the same rate as originally agreed to and incorporated in the Letter of Award. However EESL may increase this quantity, if required.

5.5 EESL's right to accept any bid and to reject any or all bids

The EESL reserves the right to accept or reject any bid, and to annul the bidding process and reject all bids at any time prior to award of contract, without thereby assigning any reason thereof and incurring any liability to the affected Bidder or bidders or any obligation to inform the affected Bidder or bidders of the grounds for the EESL's action.

5.6 Letter of Intent / Letter of Award

Prior to the expiration of the period of bid validity, the EESL will notify the successful bidder in writing by issuing Letter of Intent or Letter of Award either through telefax/ scanned e-mail or through registered/speed post/couriered letter, that its bid has been accepted. The letter of award will constitute the formation of the contract. In case, bidder does not return the duplicate copy of LOA with duly signed and acceptance within 10 days, then the LOA will be deemed to be accepted by the successful bidder, on whom award is made.

The bidder shall return duplicate copy of the Lol/LoA/contract and the other enclosed documents duly signed as a token of acceptance, within 15 days from the date of receipt of this order. Bidder is to make two original copies of contract containing Contract agreement at top, and then Letter of award, techno commercial offer, copy of price bid and copy of all tender documents are to be placed. Three more copies of the contract to be submitted by the bidder in addition to two original at bidder's own cost. Total five copies of contract including two originals copies are to be submitted. This is to be done on instructions of Contract deptt.

Upon the successful bidder's furnishing of the performance security pursuant to ITB Clause 5.9, the EESL will promptly notify each unsuccessful bidder and will discharge its bid security.

5.7 Cancellation

EESL reserves the rights to cancel the order in the part or in full by giving one week advance notice thereby if-

- The bidder fails to comply with any of the terms of the order.
- The bidder becomes bankrupt or goes in to liquidation.
- The bidder makes general assignment for the benefit of the creditors and any receiver is appointed for the property owned by the bidder.

5.8 Modifications

This order constitutes an entire agreement between the parties hereto. Any modifications to this Order shall become binding only upon the same being confirmed in writing duly signed by both the parties.

Signing the Contract Agreement

At the same time as the EESL notifies the successful Bidder that its bid has been accepted, the EESL will send the bidder the contract agreement provided in the bidding documents, incorporating all agreements between the parties.

Within twenty-one (21) days of receipt of the contract agreement, the successful bidder shall sign and date the contract agreement and return it to the EESL. Contract agreement will contain agreement on stamp paper, bid documents and bidder's offer etc.

5.9 Performance security

Within twenty-eight (28) days after receipt of the letter of award, the successful bidder shall furnish the performance security for ten percent (10%) of the contract price or as specified in tender documents

Signature :-
Subject : CN=DEEPAK MITTAL, ST=DELHI, OID.2.5.4.17=110003, OU=CONTRACTS AN
PROCUREMENT, O=ENERGY EFFICIENCY SERVICES LIMITED, C=IN
User ID : deepak.mittal
Serial No. : 33437

and in the form provided in the section "Forms and Procedures" of the bidding documents or in another form acceptable to the EESL.

In case Joint Deed(s) of Undertaking by the Contractor along with his associate(s)/collaborator(s) form part of the Contract, then, unconditional Bank Guarantee(s) from such associate(s)/collaborator(s) for amount(s) specified in Bid

Failure of the successful Bidder to comply with the requirements of ITB Clause 5.7 or Clause 5.8 shall constitute sufficient grounds for the annulment of the award and forfeiture of the bid security, in which event the EESL may make the award to the next lowest evaluated bidder or call for new bids.

5.10 Corrupt or Fraudulent practices:

The EESL requires that bidders observe the highest standard of ethics during the procurement and execution of such contracts. In pursuance of this policy, the EESL: defines, for the purposes of this provision, the terms set forth below as follows:

a. i) "corrupt practice" means the offering, giving, receiving or soliciting of anything of value to influence the action of a public official in the procurement process or in contract execution ; and

ii) "fraudulent practice" means a misrepresentation of facts in order to influence a procurement process or the execution of a contract to the detriment of the EESL, and includes collusive practice among bidders (prior to or after bid submission) designed to establish bid prices at artificial non-competitive levels and to deprive the EESL of the benefits of free and open competition;

b) will reject a proposal for award if it determines that the bidder recommended for award has engaged in corrupt or fraudulent practices in competing for the contract in question;

c) will declare a firm ineligible, either indefinitely or for a stated period of time, to be awarded a contract if it at any time determines that the firm has engaged in corrupt or fraudulent practices in competing for, or in executing, a contract of the EESL.

5.11 Ineligibility for Future Tenders

Notwithstanding the provisions specified in ITB sub clause 2.4 and ITB sub clause 5.7 and 5.8, if a bidder after having been issued and letter of award, either does not sign the contract agreement pursuant to ITB clause 5.7 or does not submit a acceptable performance security pursuant to ITB clause 5.9, such bidder may be considered ineligible for participating in future tenders of EESL for a period as may be decided by the EESL.

Successful bidder is to submit interchangeability certificate for its product supplied for replacement during warranty and maintenance period and even when it is purchased from open market. In case due to change in technology , the supplied product is not available during warranty/ maintenance period than the improved version of product can be used in warranty/ maintenance period with same or improved technical parameters or the combination thereof after written communication of Engineer in Charge at same cost& terms and conditions. Successful Bidder, on whom letter of award has been placed, has also to confirm that the prices of improved version of product is not lesser than the original product or its parts in comparison.

Note: Special Terms and Conditions will prevail upon the instruction to Bidders.

6.0 Liquidated Damages

In case of any delay in the execution of the order beyond the stipulated time schedule including any extension permitted in writing, EESL reserves the right to recover from the bidder a sum equivalent to 0.5% of the value of the delayed equipment installation/unexecuted portion of work for each week of delay and part thereof subject to a maximum of 5% of the total value of the contract.

Alternatively, EESL reserves the right to purchase and distribute equipment/ material from elsewhere at the sole risk at the cost of successful bidder/contractor and recover all such extra cost incurred by EESL in procuring the material from resources available including EMD/Bid Security/encashment of Bank Guarantee or any other sources etc. Further, if any extra cost is incurred by EESL due to delay in work completion by the party beyond the completion time as per P.O./L.O.A., the same shall also be recovered from party's invoice/EMD/BGs etc .

Signature :
Subject : CN=DEEPAK MITTAL, ST=DELHI, OID.2.5.4.17=110003, OU=CONTRACTS AN
PROCUREMENT, O=ENERGY EFFICIENCY SERVICES LIMITED, C=IN
User ID : deepak.mittal
Serial No : 33437

Alternatively, EESL may cancel the order completely or partly without prejudice to his right under the alternatives mentioned above.

7.0 Governing Law

The Contract shall be governed by and interpreted in accordance with laws in force in India. The Courts of Delhi shall have exclusive jurisdiction in all matters arising under the Contract.

8.0 Tax and Duties

8.1 Except as otherwise specifically provided in the Contract, the Implementing Partner shall bear and pay all taxes, duties, levies and charges assessed on the Implementing Partner, its Sub Implementing Partners or their employees by all municipal, state or national government authorities in connection with the Facilities in and outside of the country where the Site is located.

8.2 Notwithstanding above Sub-Clause 8.1 above, the EESL shall bear and promptly reimburse all customs and import duties, if imposed in future, on the Plant and Equipment including Type Test and mandatory spares supplied from abroad and specified in Price Schedule (and on spare parts to be supplied from abroad and specified in Schedule, when awarded) and that are to be incorporated into the Facilities, by the law of the country where the Site is located. However, if the plant and equipment are shipped in Shipper's containers, then the custom duty levied on the cost of empty containers shall be borne and paid/ reimbursed by the Implementing Partner. The EESL shall also bear and pay/ reimburse to the Implementing Partner/Assignee of Foreign Implementing Partner (if applicable) Sales Tax (but not the surcharge in lieu of Sales Tax), Local Tax including Entry Tax / Octroi (if applicable) in respect of direct transactions between the EESL and the Implementing Partner, if imposed on the Plant and Equipment including Type Test and Mandatory Spares manufactured within the EESL's country and specified in Price (and also on locally supplied spares quoted when awarded) to be incorporated in the Facilities, by the law of country where the site is located. For this purpose, the Ex-works price if quoted in foreign currency and so incorporated in the contract, shall be converted to Indian Rupees as per the TT buying exchange rates established by State Bank of India prevailing on the actual date of Ex-works (India) dispatch.

All taxes, duties and levies on works contract, if any, shall be to the Implementing Partner's account and no separate claim in this regard will be entertained by the EESL.

8.3 If any tax exemptions, reductions, allowances or privileges is available to the Implementing Partner in the country where the Site is located, the EESL shall use its best endeavors to enable the Implementing Partner to benefit from any such tax savings to the maximum allowable extent.

8.4 For the purpose of the Contract, it is agreed that the Contract Price specified in Contract Price and Terms of Payment of the Contract Agreement is based on the taxes, duties, levies and charges prevailing at the date seven (7) days prior to the last date of bid submission in the country where the Site is located (hereinafter called "Tax" in this Sub-Clause 8.4). If any rates of Tax are increased or de-created, a new Tax is introduced, an existing Tax is abolished, or any change in interpretation or application of any Tax occurs in the course of the performance of Contract, which was or will be assessed on the Implementing Partner in connection with performance of the Contract, an equitable adjustment of the Contract Price shall be made to fully take into account any such change by addition to the Contract Price or deduction there-from. However, these adjustments would be restricted to direct transactions between the EESL and the Contractor/assignee of Foreign Implementing Partner (if applicable). These adjustments shall not be applicable on procurement of raw materials, intermediary components etc. by the Implementing Partner/assignee and also not applicable on the bought out items dispatched directly from sub-vendor's works to site.

9.0 Completion Time Guarantee:

9.1 If the Successful bidder, on whom award is made/Implementing Partner/Consultant fails to attain Completion of the Facilities or any part thereof within the Time for Completion or any extension thereof under ITB Clause 2.23, the Successful bidder, on whom award is made/Implementing Partner/Consultant shall pay to the EESL liquidated damages in the amount computed at the rates specified in the SCC. The aggregate amount of such liquidated damages shall in no event exceed

Signature :-
Subject : CN=DEEPAK MITTAL, ST=DELHI, OID.2.5.4.17=110003, OU=CONTRACTS AN
PROCUREMENT, O=ENERGY EFFICIENCY SERVICES LIMITED, C=IN
User ID : deepak.mittal
Serial No : 33437

the amount specified as “Maximum” in the SCC. Once the “Maximum” is reached, the EESL may consider termination of the Contract.

Such payment shall completely satisfy the Successful bidder, on whom award is made/Implementing Partner/Consultant obligation to attain Completion of the Facilities or the relevant part thereof within the Time for Completion or any extension thereof under ITB Clause 2.23. The Implementing Partner shall have no further liability whatsoever to the EESL in respect thereof.

However, the payment of liquidated damages shall not in any way relieve the Successful bidder, on whom award is made/Implementing Partner/Consultant from any of its obligations to complete the Facilities or from any other obligations and liabilities of the Implementing Partner under the Contract.

10.0 Defect Liability

10.1 The Successful bidder, on whom award is made/Implementing Partner/Consultant warrants that the Facilities or any part thereof shall be free from defects in the design, engineering, materials and workmanship of the Plant and Equipment supplied and of the work executed, wherever applicable.

10.2 The Defect Liability Period shall be eighteen (18) months from the date of Completion of the Facilities (or any part thereof) or twelve (12) months from the date of Operational Acceptance of the Facilities (or any part thereof), whichever first occurs, unless specified otherwise in the SCC.

If during the Defect Liability Period any defect should be found in the design, engineering, materials and workmanship of the Plant and Equipment supplied or of the work executed by the Implementing Partner, the Implementing Partner shall promptly, in consultation and agreement with the EESL regarding appropriate remedying of the defects, and at its cost, repair, replace or otherwise make good (as the Implementing Partner shall, at its discretion, determine) such defect as well as any damage to the Facilities caused by such defect. The Implementing Partner shall not be responsible for the repair, replacement or making good of any defector of any damage to the Facilities arising out of or resulting from any of the following causes:

- improper operation or maintenance of the Facilities by the EESL
- operation of the Facilities outside specifications provided in the Contract.
- Normal wear and tear.

10.3 The EESL shall give the Successful bidder, on whom award is made/Implementing Partner a notice stating the nature of any such defect together with all available evidence thereof, promptly following the discovery thereof. The EESL shall afford all reasonable opportunity for the Implementing Partner to inspect any such defect.

10.4 The EESL shall afford the Implementing Partner all necessary access to the Facilities and the Site to enable the Implementing Partner to perform its obligations. The Implementing Partner may, with the consent of the EESL, remove from the Site any Plant and Equipment or any part of the Facilities that are defective if the nature of the defect, and/or any damage to the Facilities caused by the defect, is such that repairs cannot be expeditiously carried out at the Site.

10.5 If the repair, replacement or making good is of such a character that it may affect the efficiency of the Facilities or any part thereof, the EESL may give to the Implementing Partner a notice requiring that tests of the defective part of the Facilities shall be made by the Implementing Partner immediately upon completion of such remedial work, whereupon the Implementing Partner shall carry out such tests.

If such part fails the tests, the Implementing Partner shall carry out further repair, replacement or making good (as the case may be) until that part of the Facilities passes such tests. The tests in character shall in any case be not less than what has already been agreed by the EESL and the Implementing Partner for the original equipment/part of the Facilities.

10.6 If the Implementing Partner fails to commence the work necessary to remedy such defect or any damage to the Facilities caused by such defect within a reasonable time (which shall in no event be

Signature :
Subject : CN=DEEPAK MITTAL, ST=DELHI, OID.2.5.4.17=110003, OU=CONTRACTS AND
PROCUREMENT, O=ENERGY EFFICIENCY SERVICES LIMITED, C=IN
User ID : deepak.mittal
Serial No : 33437

considered to be less than fifteen (15) days), the EESL may, following notice to the Implementing Partner, proceed to do such work, and the reasonable costs incurred by the EESL in connection therewith shall be paid to the EESL by the Implementing Partner or may be deducted by the EESL from any monies due to the Implementing Partner or claimed under the Performance Security.

10.7 If the Facilities or any part thereof cannot be used by reason of such defect and/or making good of such defect, the Defect Liability Period of the Facilities or such part, as the case may be, shall be extended by a period equal to the period during which the Facilities or such part cannot be used by the EESL because of any of the aforesaid reasons. Upon correction of the defects in the Facilities or any part thereof by repair/ replacement, such repair/replacement shall have the Defect Liability Period extended by a period of twelve (12) month from the time such replacement/ repair of the Facilities or any part thereof.

10.8 In addition, the Implementing Partner shall also provide an extended warranty for any such component of the Facilities and during the period of time as may be specified in the SCC. Such obligation shall be in addition to the defect liability specified under ITB Clause 10.2 or as specified in SCC.

11.0 Functional Guarantees

11.1 The Implementing Partner guarantees that during the Guarantee Test, the Facilities and all parts thereof shall attain the Functional Guarantees as specified in the Contract Agreement, subject to and upon the conditions therein specified.

11.2 If, for reasons attributable to the Implementing Partner, the guaranteed level of the Functional Guarantees specified in the Contract Agreement are not met either in whole or in part, the Implementing Partner shall, within a mutually agreed time, at its cost and expense make such changes, modifications and/or additions to the Plant or any part thereof as may be necessary to meet such Guarantees. The Implementing Partner shall notify the EESL upon completion of the necessary changes, modifications and/or additions, and shall seek the EESL's consent to repeat the Guarantee Test. If the specified Functional Guarantees are not established even during the repeat of the Guarantee Test, the EESL may at its option, either

- Reject the Equipment and recover the payments already made, or
- Terminate the Contract and recover the payments already made, or
- Accept the equipment after levy of liquidated damages in accordance with the provisions specified in the Contract Agreement.

12.0 Inspections and Tests

12.1 Inspection of Goods: The Employer or its representative shall have the right to inspect and/or to test the Goods to confirm their conformity to the Contract specifications at no extra cost to the Employer. (SCC and the Technical Specifications shall specify what inspections and tests the Employer requires and where they are to be conducted). The Employer shall notify the Contractor in writing in a timely manner of the identity of any representatives retained for these purposes.

12.2 The inspections and tests may be conducted on the premises of the Contractor or its subcontractor(s), at point of delivery and/or at the Goods final destination. If conducted on the premises of the Contractor or its subcontractor(s), all reasonable Works and assistance, including access to drawings and production data shall be furnished to the inspectors at no cost to the Employer.

12.3 Should any inspected or tested Goods fail to conform to the specifications, the Employer may reject and the Contractor shall either replace the rejected Goods or make alterations necessary to meet specification requirements free of cost to the Employer.

12.4 The Employer's right to inspect, test and, where necessary, reject the Goods after the arrival at Site shall in no way be limited or waived by reason of the Goods having previously been inspected, tested and passed by the Employer or its Representative prior to the Goods shipment.

12.5 Nothing in GCC Clause 6 shall in any way release the Contractor from any warranty or other obligations under this Contract.

12.5 Manuals and Drawings

12.6 Before the Goods and Services are taken over by the Employer, the Contractor shall supply operation and maintenance manuals together with drawings of the goods and equipment.

Signature :-
Subject : CN=DEEPAK MITTAL, ST=DELHI, OID.2.5.4.17=110003, OU=CONTRACTS AN
PROCUREMENT, O=ENERGY EFFICIENCY SERVICES LIMITED, C=IN
User ID : deepak.mittal
Serial No : 131437

These shall be in such detail as will enable the Employer to operate, maintain, adjust and repair all parts of the equipment as stated in the specifications.

12.7 The manuals and drawings shall be in the English ruling language and in such form and numbers as stated in the contract.

12.8 Unless and otherwise agreed, the goods and equipment shall not be considered to be completed for the purpose of taking over until such manuals and drawings have been supplied to the Employer.

12.9 It shall be the obligation of the Contractor to train and familiarize the designated person by the Employer in regard to the operation manual and drawings.

13.0 Insurance

13.1 The Goods supplied under the Contract shall be fully insured in Indian Rupees against loss or damage incidental to manufacture or acquisition, transportation, storage and delivery. For delivery of goods at site, the insurance shall be obtained by the Contractor, for an amount not less than the Contract Price of the goods from "warehouse to warehouse" (final destinations) on "All Risks" basis including War risks and strikes.

14.0 Transportation, Demurrage Wharfage, Etc.

14.1 Contractor is required under the Contract to transport the Goods to place of destination defined as Site. Transport to such place of destination in India including insurance, as shall be specified in the Contract, shall be arranged by the Contractor, and the related cost shall be included in the Contract Price.

Successful bidder, on whom letter of award is placed, is to ensure all safety guidelines, rules and regulations, labour laws etc. Successful bidder indemnify EESL for any accident, injury met by its labour, employee or any other person working for him. Any compensation sought by its labour, employee or any other person working for him shall be paid by successful bidder as per settlement solely. EESL has no role to play in this matter

15.0 Warranty

15.1 The Contractor warrants that the Goods supplied under this Contract are new, unused, of the most recent or current models and that they incorporate all recent improvements in design and materials unless provided otherwise in the Contract. The Contractor further warrants that all Goods supplied under this Contract shall have no defect arising from design, materials or workmanship (except when the design and/or material is required by the Employer's Specifications) or from any act or omission of the Contractor, that may develop under normal use of the supplied Goods in the conditions prevailing in the country of final destination.

15.2 This warranty of all the Works shall remain valid for 2 year after the Commissioning. The Contractor shall, in addition, comply with the performance and/or guarantees specified under the Contract. If for reasons attributable to the Contractor, these guarantees are not attained in whole or in part, the Contractor shall:

15.3 make such changes, modifications, and/or additions to the Goods or any part thereof as may be necessary in order to attain the contractual guarantees specified in the Contract at its own cost and expense and to carry out further performance tests in accordance with SCC Clause 2; OR

15.4 pay liquidated damages to the Employer with respect to the failure to meet the contractual guarantees.

15.5. The Employer shall notify the Contractor in writing of any claims arising under this warranty.

15.6 Upon receipt of such notice, the Contractor shall, within the period of 15 days and with all reasonable speed, repair or replace the defective Goods or parts thereof, free of cost at the ultimate destination. The Contractor shall take over the replaced parts/goods at the time of their replacement. No claim whatsoever shall lie on the Employer for the replaced parts/goods thereafter. In the event of any correction of defects or replacement of defective material during the Warranty period, the Warranty for the corrected or replaced material shall be extended to a further period.

Signature :
Subject : CN=DEEPAK MITTAL, ST=DELHI, OID.2.5.4.17=110003, OU=CONTRACTS AN
PROCUREMENT, O=ENERGY EFFICIENCY SERVICES LIMITED, C=IN
User ID : deepak.mittal
Serial No : 131437

15.7 If the Contractor, having been notified, fails to remedy the defect(s) within 15 days, the Employer may proceed to take such remedial action as may be necessary, at the Contractor's risk and expense and without prejudice to any other rights which the Employer may have against the Contractor under the Contract. The performance guarantee and liquidated damages to be recovered without prejudice to other rights of the Employer.

16.0 Termination for Default

16.1 The Employer may, without prejudice to any other remedy for breach of contract, by written notice of default sent to the Contractor, terminate the Contract in whole or part:

16.2 if the Contractor fails to deliver any or all of the Goods and complete the Work within the period(s) specified in the Contract within any extension thereof granted by the Employer pursuant to GCC Clause 20; or

16.3 if the Contractor fails to perform any other obligation(s)/duties under the Contract.

16.4 If the Contractor, in the judgment of the Employer has engaged in corrupt or fraudulent practices in competing for or in executing the Contract.

16.5 In the event the Employer terminates the Contract in whole or in part, pursuant to GCC Clause 22.1, the Employer may procure, upon such terms and in such manner as it deems appropriate, Goods or Services similar to those undelivered, and the Contractor shall be liable to the Employer for any excess costs for such similar Goods or Services. However, the Contractor shall continue the performance of the Contract to the extent not terminated.

17.0. Settlement of Disputes

17.1 Adjudicator

17.1.1 If any dispute of any kind whatsoever shall arise between the EESL and the Implementing Partner in connection with or arising out of the Contract, including without prejudice to the generality of the foregoing, any question regarding its existence, validity or termination, or the execution of the Facilities—whether during the progress of the Facilities or after their completion and whether before or after the termination, abandonment or breach of the Contract—the parties shall seek to resolve any such dispute or difference by mutual consultation. If the parties fail to resolve such a dispute or difference by mutual consultation, then the dispute shall be referred in writing by either party to the Adjudicator, with a copy to the other party.

17.1.2 The Adjudicator shall give its decision in writing to both parties within twenty-eight (28) days of a dispute being referred to it. If the Adjudicator has done so, and no notice of intention to commence arbitration has been given by either the EESL or the Implementing Partner within fifty-six (56) days of such reference, the decision shall become final and binding upon the EESL and the Implementing Partner. Any decision that has become final and binding shall be implemented by the parties forthwith.

17.1.3 Should the Adjudicator resign or die, or should the EESL and the Implementing Partner agree that the Adjudicator is not fulfilling its functions in accordance with the provisions of the Contract; another retired Judge of High Court/Supreme Court of India shall be jointly appointed by the EESL and the Implementing Partner as adjudicator under the Contract. Failing agreement between the two within twenty eight (28) days, the new retired judge of High Court/Supreme Court of India shall be appointed as the Adjudicator under the Contract at the request of either party by the Appointing Authority specified in the SCC. The adjudicator shall be paid fee plus reasonable expenditures incurred in the execution of its duties as adjudicator under the contract. This cost shall be divided equally between the EESL and the Implementing Partner.

17.2 Arbitration

17.2.1 If either the EESL or the Implementing Partner is dissatisfied with the Adjudicator's decision, or if the Adjudicator fails to give a decision within twenty-eight (28) days of a dispute being referred to it, then either the EESL or the Implementing Partner may, within fifty-six (56) days of such reference, give notice to the other party, with a copy for information to the Adjudicator, of its intention to commence arbitration, as hereinafter provided, as to the matter in dispute, and no arbitration in respect of this matter may be commenced unless such notice is given.

Signature :-
Subject : CN=DEEPAK MITTAL, ST=DELHI, OID.2.5.4.17=110003, OU=CONTRACTS AND
PROCUREMENT, O=ENERGY EFFICIENCY SERVICES LIMITED, C=IN
User ID : deepak.mittal
Serial No. : 13437

17.2.2 Any dispute in respect of which a notice of intention to commence arbitration has been given, in accordance with Sub-Clause 17.2.1, shall be finally settled by arbitration. Arbitration may be commenced prior to or after completion of the Facilities.

17.2.3 Any dispute submitted by a party to arbitration shall be heard by an arbitration panel composed of three arbitrators, in accordance with the provisions set forth below.

17.2.4 The EESL and the Implementing Partner shall each appoint one arbitrator, and these two arbitrators shall jointly appoint a third arbitrator, who shall chair the arbitration panel. If the two arbitrators do not succeed in appointing a third arbitrator within twenty-eight (28) days after the latter of the two arbitrators has been appointed, the third arbitrator shall, at the request of either party, be appointed by the Appointing Authority for arbitrator designated in the SCC.

17.2.5 If one party fails to appoint its arbitrator within forty-two (42) days after the other party has named its arbitrator, the party which has named an arbitrator may request the Appointing Authority to appoint the second arbitrator.

17.2.6 If for any reason an arbitrator is unable to perform its function, the mandate of the Arbitrator shall terminate in accordance with the provisions of applicable laws as mentioned in ITB Clause 7 (Governing Law) and a substitute shall be appointed in the same manner as the original arbitrator.

17.2.7 Arbitration proceedings shall be conducted (i) in accordance with the rules of procedure designated in the SCC, (ii) in the place designated in the SCC, and (iii) in the language in which this Contract has been executed.

17.2.8 The decision of a majority of the arbitrators (or of the third arbitrator chairing the arbitration, if there is no such majority) shall be final and binding and shall be enforceable in any court of competent jurisdiction as decree of the court. The parties thereby waive any objections to or claims of immunity from such enforcement.

17.2.9 The arbitrator(s) shall give reasoned award.

17.3 Notwithstanding any reference to the Adjudicator or arbitration herein,

- the parties shall continue to perform their respective obligations under the Contract unless they otherwise agree
- the EESL shall pay the Implementing Partner any monies due to the Implementing Partner.

18.0 MSME Bidder

Are you registered as MICRO, SMALL or MEDIUM Enterprise under MSMED Act 2006?

If YES,

- A) Please indicate relevant category with copy of documentary proof issued by the concerned authorities :
- B) Does your firm fall under MSE's owned by SC/ST Entrepreneurs. If so, enclose a copy of documentary evidence:

IN ADDITION TO ABOVE FOLLOWING WILL ALSO BE APPLICABLE FOR CONSULTANCY/PROJECT MANAGEMENT CONTRACT SERVICES.

19.0 THIRD-PARTY CONSULTANCY SERVICES

19.1 The Employer (EESL) is obliged, at its own expense, to make the necessary provision for the performance of those services by third parties commissioned by it, as described in Special Conditions of Contract

20.0 SCOPE OF SERVICES

20.1 The Consultant shall deliver the Services in full and on time.

Signature :-
Subject : CN=DEEPAK MITTAL, ST=DELHI, OID.2.5.4.17=110003, OU=CONTRACTS AN
PROCUREMENT, O=ENERGY EFFICIENCY SERVICES LIMITED, C=IN
User ID : deepak.mittal
Serial No : 33437

20.2 The Services to be performed by the Consultant encompass all the part services described and explained in Special Conditions of Contract, Terms of Reference plus Tender Documents and The Consultant's bid. Furthermore, the Consultant must deliver all the standard and special services as defined intender RfP.

20.3 The Consultant shall work together with third parties wherever commissioned by the Employer. The Employer is not responsible for these third parties or their performance, when the work is assigned to consultant to co-ordinate with them. In addition, the Consultant must comprehensively coordinate their services with its own services, as far as possible.

20.1 STANDARD AND SPECIAL SERVICES

20.1.1 In addition to the Services specified explicitly in the Contract, the Consultant shall also perform all other services, if necessary, that are not listed under the contractual services, but are customarily required in order to properly discharge the contractual obligations ("standard services"). The standard services shall be fully compensated through the Agreed Remuneration in the contract.

20.1.2 "Special Services" are services that are not included under the contractual or standard services, but must necessarily be delivered by the Consultant in order to properly perform its duties under the Contract, because the external circumstances of service delivery have changed unexpectedly, or because the Employer has suspended the Services *Force Majeure* or because the Employer, with the prior consent of EESL, requires services that were not included in the invitation to tender but are necessary.

No extra cost is payable to fulfill the standard and / or special services.

20.2 DUE DILIGENCE

20.2.1 Except where otherwise stipulated in this Contract, or otherwise legally stipulated within the country or within another legal system (including the legal system in the Consultant's jurisdiction) by provisions that impose higher demands than this Contract, when performing its obligations under this Contract the Consultant shall exercise due diligence and provide the Services in compliance with professional practice and to the recognized quality standards, in accordance with current scientific and generally accepted engineering standards. The Consultant must document its work, the progress of the Project and the decisions it takes in an appropriate form that is acceptable to the Employer, bearing in mind the requirements of tender/RfP/Letter of Award.

20.3 REPORTING

20.3.1 The Consultant shall inform the Employer promptly of all extraordinary circumstances that arise *during the performance of the services and of all matters* requiring EESL approval. The consultant is to make reports as defined in scope of work and submit the same as per timelines defined in the contract.

20.4 STAFFING

20.4.1 The Consultant shall employ the staff specified in bid [Staffing Schedule] to implement performance of the Services. The list of designated key staff and any changes to it shall require the prior written approval of the Employer.

20.4.2 The Employer may require the Consultant to terminate the contract of, or replace, any staff member who fails to meet the requirements as per contract. Any such demand must be submitted in writing to the Consultant stating the reasons for it.

20.4.3 If staff employed by the Consultant need to be replaced, the Consultant shall ensure that the staff member in question is replaced promptly by an individual who possesses at least equivalent qualifications.

20.4.4 If any one of the Consultant's staff falls ill for more than one month and this jeopardizes the performance of this Contract by the Consultant, the Consultant shall replace this staff member with another staff member who possesses at least equivalent qualifications.

20.4.5 Staff shall only be replaced after prior approval by the Employer, such approval not to be unreasonably withheld. The exchange, replacement, or planned dispensation of replacement (as exception to existing rules) of key staff specified by name shall require the prior approval of EESL.

20.4.6 If the Consultant must terminate the contract of, or replace, any staff during the Contract period, the costs thus accrued shall be borne by the Consultant, except where staff are removed or replaced at the Employer's request. In this case, the Employer shall meet the costs of replacing the staff member, unless the staff member in question does not meet the requirements.

20.5 CONTACT PERSON OF THE CONSULTANT

20.5.1 The Consultant shall appoint for the exercise of all rights and obligations arising from this Contract a natural person as its contact person for the Employer under this Contract.

Subject : CN=DEEPAK MITTAL, ST=DELHI, OID.2.5.4.17=#10003, OU=CONTRACTS AN
PROCUREMENT, O=ENERGY EFFICIENCY SERVICES LIMITED, C=IN
User ID : deepak.mittal
Serial No : 136437

20.5.2 The Consultant shall specify and provide respective contact data to the Employer - for an individual at the Consultant's place of business who can be reached at any time in cases of emergency or crisis as well as a deputy of the Consultant. The Consultant shall notify the Employer without delay of any change of elected person or their contact data.

21.0 INDEPENDENCE OF THE CONSULTANT

21.1 The Consultant undertakes that neither the Consultant nor any enterprise associated with the Consultant shall bid for the Project as manufacturer, supplier, or building contractor. This prohibition also applies to any bidding for any further consulting services, insofar as such consulting services might lead to a restriction of competition or a conflict of interests. Any violation of this stipulation may lead to the immediate cancellation of this Contract and require the reimbursement of any and all costs incurred by the Employer up to the time of such violation as well as compensation for any and all losses and damages incurred by the Employer as a result of such cancellation.

22.0 COMMENCEMENT AND COMPLETION

22.1.1 The Consultant shall begin performing the Services on the prescribed date on which execution of the Contract shall take place, but not earlier than and without undue delay after the Contract has come into force. The Consultant shall deliver the Services in accordance with the time schedule in the bid [Time Schedule for the Performance of the Services defined in SCC], and shall complete the Services within the Completion Period, subject to any further extensions to this Contract accorded by employer.

22.1.2 In relation to optional services (if any), the Consultant shall commence delivery of the optional services not earlier than upon receipt of notification from the Employer,

22.1.3 Any change to the time schedule [Time Schedule for the Performance of the Services] due to a reasonable request by either party shall be mutually agreed upon in writing.

23.0 FORCE MAJEURE

In addition to Force Majeure defined in clause 2.26, following will also be applicable for consultancy work.

23.1 In the event of Force Majeure, the contractual obligations, as far as affected by such event, shall be suspended for as long as performance remains impossible due to the Force Majeure, provided that one party to the Contract receives notification of the Force Majeure event from the other party within two weeks after its occurrence and both the parties agree for that to be a force majeure. Any and all liability of the Consultant for damages arising due to its absence caused by the Force Majeure is excluded.

23.2 In the event of Force Majeure, the Consultant shall be entitled to an extension of the Contract equal to the delay caused by such Force Majeure. If the performance of the Services is rendered permanently impossible by the Force Majeure, both parties to this Contract shall be entitled to terminate the Contract on mutual agreement basis only.

23.3 In case of suspension or termination of the Contract due to Force Majeure, the Services performed up to the time of the Force Majeure and all necessary expenditure (which is evidenced) of the Consultant arising from the discontinuing of the Services shall be invoiced on the basis of contractual prices subject to employer agreement with the work. Neither party shall make any further claims.

24.0 SUSPENSIONS OR TERMINATION

24.1 The Employer may fully or partially suspend the Services or terminate this Contract after serving written notice of at least 30 days. In this event, the Consultant must immediately take all measures necessary to ensure that the Services are discontinued and the expenditure minimized. The Consultant shall hand over all reports, drafts and documents to be drawn up by the date in question to the Employer. In case of termination Force majeure shall apply mutatis mutandis.

24.2 If the Consultant fails to meet its contractual obligations without sufficient reason; in accordance with the Contract; or on time, the Employer may serve a notice upon the Consultant and request it to duly perform its Services. If the Consultant fails to remedy the performance deficit within a period of 21 days of having been called upon to do so by the Employer, the Employer shall be entitled, after this period has elapsed, to terminate the Contract by written notice.

24.3 If the termination of the Contract is due to a default on the part of the Consultant, the Consultant shall be entitled to demand the Agreed Remuneration for the Services performed until the date of

Subject: CN=DEEPAK MITTAL, S=DDELHI, OID.2.254.4.17=110009, OU=CONTRACT'S AN
PROCUREMENT, O=ENERGY EFFICIENCY SERVICES LIMITED, C=IN
User ID : deepak.mittal
Serial No : 131437

termination but not yet remunerated. The Employer shall be entitled to demand compensation for the direct damages caused by the default.

25.0 REMUNERATION OF THE CONSULTANT

25.1 The Consultant shall receive the remuneration agreed in the Special Conditions and bid price schedule for performing the Services owed under this Contract, subject to the conditions listed therein and the conditions below.

26.0 TERMS OF PAYMENT

26.1 Except where otherwise agreed in the Special Conditions, the Employer shall pay the Consultant's remuneration as follows:

- (a) Advance payment, due within 30 days of award of Contract upon presentation of an invoice against equivalent advance bank guarantee, if mentioned in SCC.
- (b) Payments based on deliverables as per tender/SCC or as agreed upon in amendments.
- (c) The final payment shall be made after the Services have been performed in full and confirmation had been provided by the Employer to that Consultant.

27.0 METHOD OF PAYMENT

Payment shall be made according to the conditions set out in the Special Conditions or as agreed upon.

28.0 INSURANCE AGAINST LIABILITY AND DAMAGES

28.1 The Consultant is advised to take out insurance for the period of the Contract, on the terms specified in the Special Conditions, including, but not limited to, the following:

- a) Professional liability insurance;
- b) Personal liability insurance;
- c) Equipment insurance covering loss of or physical damage to all equipment acquired, used, provided or paid for by the Employer within the context of this Contract; and
- d) Motor vehicle third party liability insurance and motor vehicle comprehensive insurance for the vehicles acquired in connection with this Contract.

EESL will not be responsible in case any accident/ mis-happenings with consultant employee or contract person and for any equipment damage or theft occurs and in no case EESL shall pay for it..

In case of any contradiction in ITB and SCC, than SCC will prevail.

LIST OF ACRONYMS

EMD: Earnest Money Deposit
Eol: Expression of Interest
SCC: Special Conditions of Contract
INR: Indian Rupees
IST: Indian Standard Time
LED: Light Emitting Diodes
Lol: Letter of Intent
LoA: Letter of Acceptance
MoU: Memorandum of Understanding
MoP: Ministry of Power
RECL: Rural Electrification Corporation Ltd
EESL: Energy Efficiency Services Ltd
O&M: Operation & Maintenance
RfP: Request for Proposal
R&M: Repair & Maintenance
SD: Security Deposit
CPG: Contract Performance Guarantee

Subject: CN=DEEPAK MITTAL, ST=DELHI, OID.2.5.4.17=110003, OU=CONTRACTS AN
PROCUREMENT, O=ENERGY EFFICIENCY SERVICES LIMITED, C=IN

User ID: deepak.mittal

Serial No: 131437

FTL: Fluorescent Tube Light
SVL: Sodium Vapor Lamp
PMA: Project Management Agency

Signature :-
Subject : CN=DEEPAK MITTAL, ST=DELHI, OID.2.5.4.17=110003, OU=CONTRACTS AND
PROCUREMENT, O=ENERGY EFFICIENCY SERVICES LIMITED, C=IN
User ID : deepak.mittal
Serial No : 13433

 NIT Bid Document No. EESL/06/2019-20/KUSUM/SWPS /Phase-1/Off
Id//192007012

SECTION - 2 (ITB)

Page 33 of 33

SECTION-3

GENERAL CONDITIONS OF CONTRACT (GCC)



Signature :
Subject : CN=DEEPAK MITTAL, ST=DELHI, OID.2.5.4.17=110003, OU=CONTRACTS AND
PROCUREMENT, O=ENERGY EFFICIENCY SERVICES LIMITED, C=IN
User ID : deepak.mittal
Serial No : F3FA77

GENERAL CONDITIONS CONTRACT (GCC)		
S.NO	DESCRIPTION	PAGE NO.
A.	Contract and Interpretation	
	1. Definitions	1
	2. Contract Document	2
	3. Interpretation	3
	4. Notices	5
	5. Governing Low	5
B.	Subject Matter of Contract	
	6. Settlement of Disputes	5
	7. Scope of Facilities	7
	8. Time for Commencement and completion	10
C.	Payment	
	9. Implementing Partner's Responsibilities	10
	10. EESL's Responsibilities	10
	11. Contract Price	11
D.	Intellectual Property	
	12. Terms of Payment	11
	13. Securities	11
	14. Taxes and Duties	12
E.	Work Execution	
	15. Copyright	16
	16. Confidential Information	13
	17. Representatives	14
	18. Work Program	15
	19. Subcontracting	16
	20. Design and Engineering	16
	21. Procurement	17



Signature :
Subject : CN=DEEPAK MITTAL, ST=DELHI, OID.2.5.4.17=110003, OU=CONTRACTS AND
PROCUREMENT, O=ENERGY EFFICIENCY SERVICES LIMITED, C=IN
User ID : deepak.mittal
Serial No : F3FA77

	22. Installation	19
	23. Test and Inspection	21
	24. Completion of the facilities	23
	25. Commissioning , Guarantee Test and Operational Acceptance	24
F.	Guarantees and Liabilities	
	26. Completion Time and Guarantee	25
	27. Defect Liability	25
	28. Functional Guarantees	26
	29. Patent Indemnity	27
	30. Limitation of Liability	27
G.	Risk Distribution	28
	31. Transfer of Ownership	28
	32. Care of Facilities	28
	33. Loss of or Damage to property ; Accident or Injury to Workers; Indemnification	29
	34. Insurance	30
	35. Unforeseen Conditions	32
	36. Change in Law and Regulations	32
	37. Force Majeure	32
	38. War Risks	33
H.	Change in Contract Elements	
	39. Change in the Facilities	34
	40. Extension of Time for Completion	36
	41. Suspension	36
	42. Termination	41
	43. Assignment	41
	44. Bankruptcy	41
	45. Contractor Performance & Feedback and Evaluation System	41
	46. Fraud Prevention Policy	41



Signature :
Subject : CN=DEEPAK MITTAL, ST=DELHI, OID.2.5.4.17=110003, OU=CONTRACTS AND
PROCUREMENT, O=ENERGY EFFICIENCY SERVICES LIMITED, C=IN
User ID : deepak.mittal
Serial No : F3FA77

A. Contract and Interpretation

1. Definitions

1.1 The following words and expressions shall have the meanings hereby assigned to them:

“Contract” means the Contract Agreement entered into between the EESL and the Implementing Partner, together with the Contract Documents referred to therein; they shall constitute the Contract, and the term “the Contract” shall in all such documents be construed accordingly.

“Contract Documents” means the documents listed in Article. 1.1 (Contract Documents) of the Form of Contract Agreement (including any amendments thereto).

“GCC” means the General Conditions of Contract hereof.

“SCC” means the Special Conditions of Contract.

“Day” means calendar day of the Gregorian calendar.

“Month” means calendar month of the Gregorian calendar.

“Employer” means EESL, New Delhi/Noida and includes the legal successors or permitted assigns of the EESL.

“Project Manager” means the person appointed by the EESL in the manner provided in GCC Sub-Clause 17.1 (Project Manager) hereof and named as such in the SCC to perform the duties delegated by the EESL.

“Contractor or Implementing Partner” means the person(s) whose bid to perform the Contract has been accepted by the EESL and is named as such in the Contract Agreement, and includes the legal successors or permitted assigns of the Implementing Partner.

“Contractor or Implementing Partner’s Representative” means any person nominated by the Implementing Partner and approved by the EESL in the manner provided in GCC Sub-Clause 17.2 (Implementing Partner’s Representative and Construction Manager) hereof to perform the duties delegated by the Implementing Partner.

“Sub Contractor or Sub Implementing Partner,” including vendors, means any person to whom execution of any part of the Facilities, including preparation of any design or supply of any Plant and Equipment, is subcontracted directly or indirectly by the Implementing Partner, and includes its legal successors or permitted assigns.

“Adjudicator” means the person or persons named as such in the SCC to make a decision on or to settle any dispute or difference between the EESL and the Implementing Partner referred to him or her by the parties pursuant to GCC Sub-Clause 6.1 (Adjudicator) hereof.

“Contract Price” means the sum specified in Article 2.1 (Contract Price) of the Contract Agreement, subject to such additions and adjustments thereto or deductions there from, as may be made pursuant to the Contract.

“Facilities” means the Plant and Equipment to be supplied and installed, as well as all the Installation Services to be carried out by the Implementing Partner under the Contract.

“Plant and Equipment” means permanent plant, equipment, machinery, apparatus, articles and things of all kinds to be provided and incorporated in the Facilities by the Implementing Partner under the Contract (including the spare parts to be supplied by the Implementing Partner under GCC Sub-Clause 7.3 here-of), but does not include Implementing Partner’s Equipment.

“Installation Services” means all those services ancillary to the supply of the Plant and Equipment for the Facilities, to be provided by the Implementing Partner under the Contract; e.g., transportation and provision of



marine or other similar insurance, inspection, expediting, Site preparation works (including the provision and use of Implementing Partner's Equipment and the supply of all construction materials required), installation, testing, pre-commissioning, commissioning, operations, maintenance, the provision of operations and maintenance manuals, training of EESL's Personnel etc.

"Contractor or Implementing Partner's Equipment" means all plant, facilities, equipment, machinery, tools, apparatus, appliances or things of every kind required in or for installation, completion and maintenance of Facilities that are to be provided by the Implementing Partner, but does not include Plant and Equipment, or other things intended to form or forming part of the Facilities.

"Site" means the land and other places upon which the Facilities are to be installed, and such other land or places as may be specified in the Contract as forming part of the Site.

"Effective Date" means the date from which the Time for Completion shall be determined as stated in Article 3 (Effective Date for Determining Time for Completion) of the Form of Contract Agreement.

"Time for Completion" means the time within which Completion of the Facilities as a whole (or of a part of the Facilities where a separate Time for Completion of such part has been prescribed) is to be attained in accordance with the stipulations in the SCC and the relevant provisions of the Contract.

"Completion" means that the Facilities (or a specific part thereof where specific parts are specified in the SCC) have been completed operationally and structurally and put in a tight and clean condition, and that all work in respect of Pre-commissioning of the Facilities or such specific part thereof has been completed; and Commissioning has been attained as per Technical Specifications.

"Pre-commissioning" means the testing, checking and other requirement specified in the Technical Specifications that are to be carried out by the Implementing Partner in preparation for Commissioning as provided in GCC Clause 24 (Completion) hereof.

Commissioning" means trial/intial operation of the Facilities or any part thereof by the Implementing Partner, which operation is to be carried out by the Contractor as provided in GCC Sub-Clause 25.1 (Commissioning) hereof, for the purpose of carrying out Guarantee Test(s).

"Guarantee Test(s)" means the test(s) specified in the Technical Specifications to be carried out to ascertain whether the Facilities or a specified part thereof is able to attain the Functional Guarantees specified in the Technical Specifications in accordance with the provisions of GCC Sub Clause 25.2 (Guarantee Test) hereof.

Operational Acceptance" means the acceptance by the EESL of the Facilities (or any part of the Facilities where the Contract provides for acceptance of the Facilities in parts), which certifies the Implementing Partner's fulfilment of the Contract in respect of Functional Guarantees of the Facilities (or the relevant part thereof) in accordance with the provisions of GCC Clause 28 (Functional Guarantees) hereof and shall include deemed acceptance in accordance with GCC Clause 25 (Commissioning and Operational Acceptance) hereof.

Defect LiabilityPeriod" means the period of validity of the warranties given by the Implementing Partner commencing at Completion of the Facilities or a part thereof, during which the Implementing Partner is responsible for defects with respect to the Facilities (or the relevant part thereof) as provided in GCC Clause 27 (Defect Liability) hereof.

2. Contract Documents

2.1 Subject to Article 1.2 (Order of Precedence) of the Contract Agreement all documents forming part of the Contract (and all parts thereof) are intended to be correlative, complementary and mutually explanatory. The Contract shall be read as a whole.

2.2 The Contract will be signed in three originals and the Implementing Partner shall be provided with one signed original and the rest will be retained by the EESL.

2.3 The Implementing Partner shall provide free of cost to the EESL all the engineering data, drawing and descriptive materials submitted with the bid, in at least five (5) copies to form a part of the Contract immediately after Notification of Award/ letter of Award.



2.4 Subsequent to signing of the Contract, the Implementing Partner at his own cost shall provide the EESL with at least five(05) true copies of Contract Agreement within thirty (30) days after signing of the Contract.

3. Interpretation

3.1 Language

3.1.1 Unless the Implementing Partner is a national of the EESL's country and the EESL and the Implementing Partner agree to use the local language, all Contract Documents, all correspondence and communications to be given, and all other documentation to be prepared and supplied under the Contract shall be written in English, and the Contract shall be construed and interpreted in accordance with that language.

3.1.2 If any of the Contract Documents, correspondence or communications are prepared in any language other than the governing language under GCC Sub-Clause 3.1.1 above, the English translation of such documents, correspondence or communications shall prevail in matters of interpretation.

3.2 Singular and Plural

The singular shall include the plural and the plural the singular, except where the context otherwise requires.

3.3 Headings

The headings and marginal notes in the General Conditions of Contract are included for ease of reference, and shall neither constitute a part of the Contract nor affect its interpretation.

3.4 Persons

Words importing persons or parties shall include firms, corporations and government entities.

3.5 Inco terms

Unless inconsistent with any provision of the Contract, the meaning of any trade term and the rights and obligations of parties there under shall be as prescribed by Incoterms.

Inco terms means international rules for interpreting trade terms published by the International Chamber of Commerce (latest edition), 38 Cours Albert 1er, 75008 Paris, France.

3.6 Construction of the Contract

3.6.1 The Contracts to be entered into between the EESL and the successful bidder shall be as under :

- i) First Contract: For Ex-works (India) supply of plant and equipment and accessories by bidder including mandatory spares and spares to be supplied during warranty
- ii) Second Contract: for providing all services i.e. loading, inland/air/shipment transportation for delivery at site, inland/air/shipment transit insurance, unloading, storage, handling at site, installation, insurance covers other than inland transit insurance, testing, commissioning and conducting Guarantee tests in respect of all the equipments supplied under the 'First Contract' and all other services including civil works, if any, as specified in the Contract Documents including sales tax and duties as asked in price bid in section IV. It will also cover cost for Repair and Maintenance and equipmentsand/or additional warranty, where ever asked for ,supplied under the 'First Contract' and all other services including civil works, if any, as specified in the Contract Documents. All items in second contract must be quoted including service tax.
- iii) Third Contract: For providing all services including Awareness programme for public/stake holders/workshops/printing brochure and other materials, Survey cost, Monitoring and verification cost, scrap disposal cost, arrangement of office at both sites and Statuary agencies cost including service tax.

All the above Contracts will contain a cross-fall breach clause specifying that breach of one Contract will constitute breach of the other Contracts which will confer a right on the Employer to terminate the other Contracts also at the risk and the cost of the contractor /Implementing Partner for the Project, for which awards have been made.

In case, value of second contract viz transportation, insurance is lower or the supply cost includes transportation, insurance etc than three contract may be merged in two contract.



Arbitration: 1. Appointing authority for adjudicator: MD, EESL

2. The place of arbitration shall be: New Delhi

Prices are to be quoted as Firm during currency of contract. No price adjustment is allowed.

General:

1. In case of investment partner, A project manager is to be deputed from their side for co-ordinating activities.
2. Word Implementing Partner for any Project used in General Conditions of contract includes persons of Investment partner, executing and implementing agencies etc
3. Notification of award means Letter of Intent and Letter of award

3.6.2 The award of separate Contracts shall not in any way dilute the responsibility of the Implementing Partner for the successful completion of the Facilities as per Contract Documents and a breach in one Contract shall automatically be construed as a breach of the other Contract(s) which will confer a right on the EESL to terminate the other Contract(s) also at the risk and the cost of the Implementing Partner.

3.7 Entire Agreement

Subject to GCC Sub-Clause 16.4 hereof, the Contract constitutes the entire agreement between the EESL and Implementing Partner with respect to the subject matter of Contract and supersedes all communications, negotiations and agreements (whether written or oral) of parties with respect thereto made prior to the date of Contract.

3.8 Amendment

No amendment or other variation of the Contract shall be effective unless it is in writing, is dated, expressly refers to the Contract, and is signed by a duly authorized representative of each party here to.

3.9 Independent Contractor or Implementing Partner

The Implementing Partner shall be an independent Implementing Partner performing the Contract. The Contract does not create any agency, partnership, joint venture or other joint relationship between the parties here to.

Subject to the provisions of the Contract, the Contractor or Implementing Partner shall be solely responsible for the manner in which the Contract is performed. All employees, representatives or Sub Contractor or Sub Implementing Partners engaged by the Implementing Partner in connection with the performance of the Contract shall be under the complete control of the Implementing Partner and shall not be deemed to be employees of the EESL, and nothing contained in the Contract or in any subcontract awarded by the Implementing Partner shall be construed to create any contractual relationship between any such employees, representatives or Sub Contractor or Sub Implementing Partners and the EESL.

3.10 Joint Venture or Consortium

If the Implementing Partner is a joint venture or consortium of two or more firms, all such firms shall be jointly and severally bound to the EESL for the fulfilment of the provisions of the Contract and shall designate one of such firms to act as a leader with authority to bind the joint venture or consortium. The composition or the constitution of the joint venture or consortium shall not be altered without the prior consent of the EESL.

3.11 Non-Waiver

3.11.1 Subject to GCC Sub-Clause 3.11.2 below, no relaxation, forbearance, delay or indulgence by either party in enforcing any of the terms and conditions of the Contract or the granting of time by either party to the other shall prejudice, affect or restrict the rights of that party under the Contract, nor shall any waiver by either party of any breach of Contract operate as waiver of any subsequent or



continuing breach of Contract.

3.11.2 Any waiver of a party's rights, powers or remedies under the Contract must be in writing, must be dated and signed by an authorized representative of the party granting such waiver, and must specify the right and the extent to which it is being waived.

3.12 Severability

If any provision or condition of the Contract is prohibited or rendered invalid or unenforceable, such prohibition, invalidity or unenforceability shall not affect the validity or enforceability of any other provisions and conditions of the Contract.

3.13 Country of Origin

"Origin" means the place where the materials, equipment and other supplies for the Facilities are mined, grown, produced or manufactured, and from which the services are provided.

4. Notices

4.1 Unless otherwise stated in the Contract, all notices to be given under the Contract shall be in writing, and shall be sent by personal delivery, airmail post, special courier, cable, telegraph, telex, facsimile or Electronic Data Interchange (EDI) to the address of the relevant party set out in the Contract Coordination Procedure to be finalised pursuant to GCC Sub-Clause 17.2.3.1, with the following provisions.

4.1.1 Any notice sent by cable, telegraph, facsimile or shall be confirmed within two (2) days after despatch by notice sent by airmail/ post or special courier, except as otherwise specified in the Contract.

4.1.2 Any notice sent by airmail post or special courier shall be deemed (in the absence of evidence of earlier receipt) to have been delivered ten (10) days after despatch. In proving the fact of despatch, it shall be sufficient to show that the envelope containing such notice was properly addressed, stamped and conveyed to the postal authorities or courier service for transmission by airmail or special courier.

4.1.3 Any notice delivered personally or sent by telegraph, facsimile shall be deemed to have been delivered on date of its despatch.

4.1.4 Either party may change its postal, cable, telex, facsimile or EDI address or addressee for receipt of such notices by ten (10) days' notice to the other party in writing.

4.2 Notices shall be deemed to include any approvals, consents, instruction orders and certificates to be given under the Contract.

5. Governing Law

5.1 The Contract shall be governed by and interpreted in accordance with laws in force in India. The Courts of Delhi shall have exclusive jurisdiction in all matters arising under the Contract.

6. Settlement of Disputes

6.1 Adjudicator

6.1.1 If any dispute of any kind whatsoever shall arise between the EESL and the Implementing Partner in connection with or arising out of the Contract, including without prejudice to the generality of the foregoing, any question regarding its existence, validity or termination, or the execution of the Facilities—whether during the progress of the Facilities or after their completion and whether before or after the termination, abandonment or breach of the Contract—the parties shall seek to resolve any such dispute or difference by mutual consultation. If the parties fail to resolve such a dispute or difference by mutual consultation, then the dispute shall be referred in writing by either party to the Adjudicator, with a copy to the other party.

6.1.2 The Adjudicator shall give its decision in writing to both parties within twenty-eight (28) days of a dispute being referred to it. If the Adjudicator has done so, and no notice of intention to commence arbitration has been given by either the EESL or the Implementing Partner within fifty-six (56) days of such reference, the decision shall become final and binding upon the EESL and the Implementing Partner. Any decision that has become final and binding shall be implemented by the parties forthwith.

6.1.3 Should the Adjudicator resign or die, or should the EESL and the Implementing Partner agree that the



Adjudicator is not fulfilling its functions in accordance with the provisions of the Contract; another retired Judge of High Court/Supreme Court of India shall be jointly appointed by the EESL and the Implementing Partner as adjudicator under the Contract. Failing agreement between the two within twenty eight (28) days, the new retired judge of High Court/Supreme Court of India shall be appointed as the Adjudicator under the Contract at the request of either party by the Appointing Authority specified in the SCC. The adjudicator shall be paid fee plus reasonable expenditures incurred in the execution of its duties as adjudicator under the contract. This cost shall be divided equally between the EESL and the Implementing Partner.

6.2 Arbitration

6.2.1 If either the EESL or the Implementing Partner is dissatisfied with the Adjudicator's decision, or if the Adjudicator fails to give a decision within twenty-eight (28) days of a dispute being referred to it, then either the EESL or the Implementing Partner may, within fifty-six (56) days of such reference, give notice to the other party, with a copy for information to the Adjudicator, of its intention to commence arbitration, as hereinafter provided, as to the matter in dispute, and no arbitration in respect of this matter may be commenced unless such notice is given.

6.2.2 Any dispute in respect of which a notice of intention to commence arbitration has been given, in accordance with GCC Sub-Clause 6.2.1, shall be finally settled by arbitration. Arbitration may be commenced prior to or after completion of the Facilities.

In case the Contractor is a Public Sector Enterprise or a Government Department

6.2.3 In case the Contractor is a Public Sector Enterprise or a Government Department, the dispute shall be referred for resolution in Permanent Machinery for Arbitration (PMA) of the Department of Public Enterprise, Government of India. Such dispute or difference shall be referred by either party for Arbitration to the sole Arbitrator in the Department of Public Enterprises to be nominated by the Secretary to the Government of India in-charge of the Department of Public Enterprises. The award of the Arbitrator shall be binding upon the parties to the dispute, provided, however, any party aggrieved by such award may make a further reference for setting aside or revision of the award to the Law Secretary, Department of Legal Affairs, Ministry of Law & Justice, Government of India. Upon such reference the dispute shall be decided by the Law Secretary or the Special Secretary/Additional Secretary, when so authorized by the Law Secretary, whose decision shall bind the Parties finally and conclusively. The Parties to the dispute will share equally the cost of arbitration as intimated by the Arbitrator.

In case the Contractor is not a Public Sector Enterprise or a Government Department

6.2.4 In all other cases, any dispute submitted by a party to arbitration shall be heard by an arbitration panel composed of three arbitrators, in accordance with the provisions set forth below.

6.2.5 The Employer and the Contractor shall each appoint one arbitrator, and these two arbitrators shall jointly appoint a third arbitrator, who shall chair the arbitration panel. If the two arbitrators do not succeed in appointing a third arbitrator within twenty-eight (28) days after the latter of the two arbitrators has been appointed, the third arbitrator shall, at the request of either party, be appointed by the Appointing Authority for arbitrator designated in the SCC.

6.2.6 If one party fails to appoint its arbitrator within forty-two (42) days after the other party has named its arbitrator, the party which has named an arbitrator may request the Appointing Authority to appoint the second arbitrator.

6.2.7 If for any reason an arbitrator is unable to perform its function, the mandate of the Arbitrator shall terminate in accordance with the provisions of applicable laws as mentioned in GCC Clause 5 (Governing Law) and a substitute shall be appointed in the same manner as the original arbitrator.

6.2.8 Arbitration proceedings shall be conducted in accordance with The Arbitration and Conciliation Act, 1996 and its subsequent thereof. The venue of arbitration shall be New Delhi.

6.2.9 The decision of a majority of the arbitrators (or of the third arbitrator chairing the arbitration panel, if there is no such majority) shall be final and binding and shall be enforceable in any court of competent jurisdiction as decree of the court. The parties thereby waive any objections to or claims of immunity



from such enforcement.

6.2.10 The arbitrator(s) shall give reasoned award.

Notwithstanding any reference to the Adjudicator or arbitration herein,

the parties shall continue to perform their respective obligations under the Contract unless they otherwise agree

the Employer shall pay the Contractor any monies due to the Contractor.

B. Subject Matter of Contract

7. Scope of Facilities

7.1 Unless otherwise expressly limited in the Technical Specifications, the Implementing Partner's obligations cover the provision of all Plant and Equipment and the performance of all Installation Services required for the design, the manufacture (including procurement, quality assurance, construction, installation, associated civil works, Precommissioning and delivery) of the Plant and Equipment and the installation, completion, commissioning and performance testing of the Facilities in accordance with the plans, procedures, specifications, drawings, codes and any other documents as specified in the Technical Specifications. Such specifications include, but are not limited to, the provision of supervision and engineering services; the supply of labour, materials, equipment, spare parts (as specified in GCC Sub-Clause 7.3 below) and accessories; Implementing Partner's Equipment; construction utilities and supplies; temporary materials, structures and facilities; transportation (including, without limitation, unloading and hauling to, from and at the Site); and storage, except for those supplies, works and services that will be provided or performed by the EESL, as set forth in Appendix 6 (Scope of Works and Supply by the EESL) to the Contract Agreement.

7.2 The Contractor or Implementing Partner shall, unless specifically excluded in the Contract, perform all such work and/or supply all such items and materials not specifically mentioned in the Contract but that can be reasonably inferred from the Contract as being required for attaining Completion of the Facilities as if such work and/or items and materials were expressly mentioned in the Contract.

7.3 In addition to the supply of Mandatory Spare Parts if asked and warranty spares included in the Contract, the Implementing Partner agrees to supply spare parts required for the operation and maintenance of the Facilities. However, the identity, specifications and quantities of such spare parts and the terms and conditions relating to the supply thereof are to be agreed between the EESL and the Implementing Partner, and the price of such if asked spare parts shall be that given in Price Schedule which shall be added to the Contract Price. The price of such spare parts shall include the purchase price there for and other costs and expenses (including the Implementing Partner's fees) relating to the supply of spare parts. The prices of spares covered under the Price Schedule shall be kept valid for a period as specified in SCC.

7.3.1 The Contractor / Implementing Partner agrees that the spare parts recommended by him for 3 years operation and quoted in price Schedule shall be supplied by him at the same terms and conditions as are otherwise applicable to this Contract. Further, the Implementing Partner also agrees to supply spare parts required for the operation and maintenance of the Facilities as per provision of subsequent paragraphs of this Sub-Clause.

7.3.1.1 All the spares for the equipment under the Contract will strictly conform to the Specification and other relevant documents and will be identical to the corresponding main equipment/components supplied under the Contract and shall be fully interchangeable.

7.3.1.2 All the mandatory spares covered under the Contract shall be produced along with the main equipment as a continuous operation and the delivery of the spares will be effected along with the main equipment in a phased manner and the delivery would be completed by the respective dates for the various categories of equipment as per the agreed network. In case of recommended spares the above will be applicable provided



the orders for the recommended spares have been placed with the Implementing Partner prior to commencement of manufacture of the main equipment.

7.3.1.3 The Implementing Partner will provide the EESL with the manufacturing drawings, catalogues, assembly drawings and any other document required by the EESL so as to enable the EESL to identify the recommended spares. Such details will be furnished to the EESL as soon as they are prepared but in any case not later than six months prior to commencement of manufacture of the corresponding main equipment.

7.3.1.4 To enable the EESL to finalise the requirement of recommended spares which are ordered subsequent to placement of order for main equipment/plant, in addition to necessary technical details, catalogue and such other information brought-out herein above, the Implementing Partner will also provide a justification in support of reasonableness of the quoted prices of spares which will, inter-alia, include documentary evidence that the prices quoted by the Implementing Partner to the EESL are not higher than those charged by him from other customers in the same period.

7.3.1.5 In addition to the spares recommended by the Implementing Partner, if the EESL further identifies certain items of spares, the Implementing Partner will submit the prices and delivery quotation for such spares within thirty (30) days of receipt of such request with a validity period of six (6) months for consideration by the EESL and placement of order for additional spares if the EESL so desires.

7.3.1.6 The quality plan and the inspection requirement finalised for the main equipment will also be applicable to the corresponding spares.

7.3.1.7 The Contractor or Implementing Partner will provide the EESL with all the addresses and particulars of his sub-suppliers while placing the order on vendors for items/components/equipment covered under the Contract and will further ensure with his vendors that the EESL, if so desires, will have the right to place order for spares directly on them on mutually agreed terms based on offers of such vendors.

7.3.1.8 The Contractor or Implementing Partner shall guarantee the long term availability of spares to the EESL for the full life of the equipment covered under the Contract. The Implementing Partner shall guarantee that before going out of production of spare parts of the equipment covered under the Contract, he shall give the EESL at least 2 years advance notice so that the latter may order his bulk requirement of spares, if it so desires. The same provision will also be applicable to Sub-Implementing Partners. Further, in case of discontinuance of manufacture of any spares by the Contractor and/or his Sub-Contractor or Implementing Partner, Implementing Partner will provide the EESL, two years in advance, with full manufacturing drawings, material specification and technical information including information on alternative equivalent makes required by the EESL for the purpose of manufacture/procurement of such items.

7.3.1.9 The prices of all future requirements of item of spares beyond 3 years operational requirement will be derived from the corresponding ex-works price at which the order for such spares have been placed by EESL as a part of mandatory spares or recommended spares, or from the rates of mandatory spares or recommended spares as quoted by/ negotiated with the Implementing Partner. Ex-works order price of future spares shall be computed in accordance with the price adjustment provisions covered under the main Contract excepting that the base indices will be counted from the scheduled date of Commissioning of the last equipment under the main project and there will be no ceiling on the amount of variation in the prices. The above option for procuring future recommended spares by the EESL shall remain valid for the period of 5 years from the date of Commissioning of the equipment.

7.3.1.10 The Implementing Partner will indicate in advance the delivery period of the items of spares, which the EESL may procure in accordance with above sub-clause. In case of emergency requirements of spares, the Contractor would make every effort to expedite the manufacture and delivery of such spares on the basis of mutually agreed time schedule.

7.3.1.11 In case the Implementing Partner fails to supply the mandatory, recommended or long term spares in the terms stipulated above, the EESL shall be entitled to purchase the same from the alternate sources at the risk and the cost of the Implementing Partner and recover from the Implementing Partner, the excess amount paid by the EESL over the rates worked on the above basis. In the event of such risk purchase by the EESL, the purchases will be as per the Works and Procurement Policy of the EESL prevalent at the time of such purchases and the EESL at his option may include a representative from the Implementing Partner in finalising the purchases.



7.3.1.11 It is expressly understood that the final settlement between the parties in terms of relevant clauses of the Contract Documents shall not relieve the Implementing Partner of any of his obligations under the provision of long term availability of spares and such provisions shall continue to be enforced till the expiry of 5 years period reckoned from the scheduled date of Commissioning of the Plant and Equipment unless otherwise discharged expressly in writing by the EESL. Further, the provisions pertaining to long term availability of spares shall be extended beyond 5 years applicability period mentioned hereinabove if so desired by the EESL and at the mutually acceptable escalation formula.

7.3.1.13 The Implementing Partner shall warrant that all spares supplied will be new and in accordance with the Contract Documents and will be free from de-fects in design, material and workmanship and shall further guarantee as under:

- (i) For 3 years operational spares (both mandatory and recommended)
 - a) For any item of spares ordered or to be ordered by the EESL for 3 years operational requirement of the plant which are manufactured as a continuous operation together with the corresponding main equipment/component, the Defect Liability Period will be twelve (12) months from the scheduled date of commercial operation of main equipment/ plant under the Contract. 'Commercial Operation' shall mean the conditions of operation in which the complete equipment covered under the Contract is officially declared by the EESL to be available for continuous operation at different loads upto and including rated capacity. Such declaration by the EESL, however, shall not relieve or prejudice the Implementing Partner any of his obligations under the Contract. In case of any failure in the original component/equipments due to faulty designs, materials and workmanship, the corresponding spare parts, if any, supplied will be replaced without any extra cost to the EESL unless a joint examination and analysis by the EESL and the Implementing Partner of such spare parts prove that the defect found in the original part that failed, can safely be assumed not to be present in spare parts. Such replaced spare parts will have the same Defect Liability as applicable to the replacement made for the defective original part/component provided that such replacement for the original equipment and the spare replaced are again manufactured together. The discarded spare parts will become the property of the Implementing Partner as soon as they have been replaced by the Implementing Partner.
 - b) For the item of spares ordered or to be ordered by the EESL for 3 years operational requirement of the plant, which with the written approval of the EESL, are not manufactured as a continuous operation will be warranted for 7000 hrs of trouble free operation if used within a period of eighteen (18) months reckoned from the date of delivery at site. However, if such spare parts are put to use after eighteen (18) months of the delivery at Site then the guarantee of such spares will stand valid till the expiry of thirty six (36) months from the scheduled date of Commissioning of equipment/plant covered under the contract or 7000 hrs of trouble free operation after such spares are put in service, whichever is earlier.
 - c) For long term requirement

For item of spares that may be ordered by the EESL to cover requirements beyond 3 years of Initial Operation of the plant, the warranty will be till the expiry of 7000 hrs of trouble free operation if used within a period of eighteen (18) months from the date of delivery at site. For item of spares that may be used after eighteen (18) months from the date of delivery at site, the warranty period will be 12 months from the date they are put to use or 7000 hrs of trouble free operation, whichever is earlier. In any case the defect liability of spares will expire at the end of forty eight (48) months from the date of their receipt at site.

- (ii) The Defect Liability of spares covered in para (b) & (c) above, that are not used within 18 months from the respective date of the delivery at Site will, however, be subject to condition that all such spares being stored/maintained/preserved in accordance with Implementing Partner's standard recommended practice, if any, and the same has been furnished to the EESL.



8. Time for Commencement and Completion

8.1 The Implementing Partner shall commence work on the Facilities from the date of Notification of Award and without prejudice to GCC Sub-Clause 26.2 hereof, the Implementing Partner shall thereafter proceed with the Facilities in accordance with the time schedule specified in Appendix 4 (Time Schedule) to the Contract Agreement or / and as mentioned in special conditions of contract.

8.2 The Implementing Partner shall attain Completion of the Facilities (or of a part where a separate time for Completion of such part is specified in the Contract) within the time stated in the SCC or within such extended time to which the Implementing Partner shall be entitled under GCC Clause 40 (Extension of Time for Completion) hereof.

9. Contractor or Implementing Partner's Responsibilities

9.1 The Contractor or Implementing Partner shall design, manufacture (including associated purchases and/or subcontracting), install and complete the Facilities with due care and diligence in accordance with the Contract.

9.2 The Contractor or Implementing Partner confirms that it has entered into this Contract on the basis of a proper examination of the data relating to the Facilities (including any data as to boring tests) provided by the EESL, and on the basis of information that the Contractor or Implementing Partner could have obtained from a visual inspection of the Site (if access thereto was available) and of other data readily available to it relating to the Facilities as at the date twenty-eight (28) days prior to bid submission. The Implementing Partner acknowledges that any failure to acquaint itself with all such data and information shall not relieve its responsibility for properly estimating the difficulty or cost of successfully performing the Facilities.

9.3 The Implementing Partner shall acquire in its name all permits, approvals and/or licenses from all local, state or national government authorities or public service undertakings in the country where the Site is located that are necessary for the performance of the Contract, including, without limitation, visas for the Contractor or Implementing Partner's and Sub Contractor or Implementing Partner's personnel and entry permits for all imported Implementing Partner's Equipment. The Implementing Partner shall acquire all other permits, approvals and/or licenses that are not the responsibility of the EESL under GCC Sub-Clause 10.3 hereof and that are necessary for the performance of the Contract.

9.4 The Implementing Partner shall comply with all laws in force in the country where the Facilities are installed and where the Installation Services are carried out. The laws will include all national, provincial, municipal or other laws that affect the performance of the Contract and bind upon the Implementing Partner. The Implementing Partner shall indemnify and hold harmless the EESL from and against any and all liabilities, damages, claims, fines, penalties and expenses of whatever nature arising or resulting from the violation of such laws by the Contractor or Implementing Partner or its personnel, including the Contractor or Sub Implementing Partners and their personnel, but without prejudice to GCC Sub Clause 10.1 hereof.

9.5 Any Plant, Material and Services that will be incorporated in or be required for the Facilities and other supplies shall have their origin as specified under GCC Clause 3.13 (Country of Origin).

10. EESL's Responsibilities

10.1 The EESL shall ensure the accuracy of all information and/or data to be supplied by the EESL as described in Appendix 6 (Scope of Works and Supply by the EESL) to the Contract, except when otherwise expressly stated in the Contract.

10.2 The EESL shall be responsible for acquiring and providing legal and physical possession of the Site and access thereto, and for providing possession of and access to all other areas reasonably required for the proper execution of the Contract, including all requisite rights of way, as specified in Appendix 6 (Scope of Works and Supply by the EESL) to the Contract Agreement. The EESL shall give full possession of and accord all rights of access thereto on or before the date(s) specified in Appendix 6.

10.3 The EESL shall acquire and pay for all permits, approvals and/or licenses from all local, state or national government authorities or public service undertakings in the country where the Site is located which such authorities or undertakings require the EESL to obtain them in the EESL's name, are necessary for the execution of the Contract (they include those required for the performance by both the Implementing Partner and the EESL of their respective obligations under the Contract), including those specified in Appendix 6 (Scope of Works and Supply by the EESL) to the Contract Agreement.

10.4 If requested by the Implementing Partner, the EESL shall use its best endeavours to assist the Implementing



Partner in obtaining in a timely and expeditious manner all permits, approvals and/or licenses necessary for the execution of the Contract from all local, state or national government authorities or public service undertakings that such authorities or undertakings require the Contractor or Implementing Partner or Sub Contractor or Implementing Partners or the personnel of the Contractor or Implementing Partner or Sub Contractor or Implementing Partners, as the case may be, to obtain.

10.5 Unless otherwise specified in the Contract or agreed upon by the EESL and the Implementing Partner, the EESL shall provide sufficient, properly qualified operating and maintenance personnel; shall supply and make available all raw materials, utilities, lubricants, chemicals, catalysts other materials and facilities ; and shall perform all work and services of whatsoever nature, to enable the Implementing Partner to properly carry out Precommissioning, Commissioning and Guarantee Tests, all in accordance with the provisions of Appendix 6 (Scope of Works and Supply by the EESL) to the Contract Agreement at or before the time specified in the program furnished by the Contractor or Implementing Partner under GCC Sub- Clause 18.2 (Program of Performance) hereof and in the manner there-upon specified or as otherwise agreed upon by the EESL and the Contractor or Implementing Partner.

10.6 The EESL shall be responsible for the continued operation of the Facilities after Completion, in accordance with GCC Sub-Clause 24.8, and shall be responsible for facilitating the Guarantee Test(s) for the Facilities, in accordance with GCC Sub-Clause 25.2.

10.7 All costs and expenses involved in the performance of the obligations under this GCC Clause 10 shall be the responsibility of the EESL save those to be incurred by the Implementing Partner with respect to the performance of Guarantee Tests, in accordance with GCC Sub-Clause 25.2.

C. Payment

11. Contract Price

11.1 The Contract Price shall be as specified in Article 2 (Contract Price and Terms of Payment) of the Form of Contract Agreement.

11.2 The Contract Price shall be adjusted in accordance with provisions of Appendix-2 (Price Adjustment) to the Contract Agreement, if applicable. It will be mentioned in SCC.

11.3 Subject to GCC Sub-Clauses 9.2, 10.1 and 35 (Unforeseen Conditions) hereof, the Implementing Partner shall be deemed to have satisfied itself as to the hereof, correctness and sufficiency of the Contract Price, which shall, except as otherwise provided for in the Contract, cover all its obligations under the Contract.

12. Terms of Payment

12.1 The Contract price shall be paid as specified in Appendix 1 (Terms and Procedures of Payment) to the Contract Agreement. The procedures to be followed in making application for and processing payments shall be those outlined in the same Appendix 1.

12.2 No payment made by the EESL herein shall be deemed to constitute acceptance by the EESL of the Facilities or any part(s) thereof.

12.3 The currency or currencies in which payments are made to the Implementing Partner under this Contract shall be specified in Appendix 1 (Terms and Procedures of Payment) to the Contract Agreement, subject to the general principle that payments will be made in the currency or currencies in which the Contract Price has been stated in the Contract.

13. Securities

13.1 Issuance of Securities

The Implementing Partner shall provide the securities specified below in favour of the EESL at the times, and in the amount, manner and form specified below.

13.2 Advance Payment Security

13.2.1 The Implementing Partner shall, within twenty-eight (28) days of the notification of contract award, provide a security in an amount equal to the advance payment calculated in accordance with Appendix 1 (Terms and Procedures of Payment) to the Contract Agreement, and in the currency or currencies of the contract, with a initial validity of up to ninety (90) days beyond the schedule date of Completion of the Facilities in accordance with GCC



Clause 24. However, in case of delay in completion of facilities under the package, the validity of the security shall be extended by the period of such delay.

13.2.2 The security shall be in the form of an unconditional bank guarantee as per the proforma provided in Section VII (Forms and Procedures)- Form of Advance Payment Security. The Advance payment Security shall be reduced prorata every three (3) months after First Running Account Bill/Stage Payment under the Contract based on the value of equipment/facilities received. The cumulative amount of reduction at any point of time shall not exceed seventy five percent (75%) of the advance corresponding to cumulative value of the respective equipment Facilities supplied and received as per a certificate issued by the Project Manager and the balance of 25% released after ninety (90) days beyond the Completion of those Facilities. It should be clearly understood that reduction in the value of security for advances shall not in any way dilute the Implementing Partner's responsibility and liabilities under the Contract including in respect of the Facilities for which the reduction in the value of security is allowed.

13.3 Contract Performance Security

13.3.1 The Implementing Partner shall, within twenty-eight (28) days of the Notification of Award, provide securities for the due performance of the Contract for ten percent (10%) of the Contract Price of all the Contracts, with an initial validity upto ninety (90) days beyond the end of scheduled Defect Liability Period of the last equipment covered under the package. If the EESL accepts to enter into 'Second Contract' and/or 'Third Contract' with the Assignee of a foreign Implementing Partner, pursuant to GCC Sub-Clause 3.6, the said Assignee, in addition to the Contract Performance Securities to be provided by the foreign Implementing Partner for ten percent (10%) of the value of all the Contracts i.e. First Contract, Second Contract and Third Contract, shall provide within twenty eight (28) days of the Notification of Award, separate Contract Performance Security(ies) equivalent to ten percent (10%) of the value of Contract(s) entered into with the Assignee, for the due performance of Contract, with an initial validity up to ninety (90) days beyond the end of Scheduled Defect Liability period of the last equipment covered under the package. However, in case of delay in completion of the defect liability period, the validity of all the contract performance securities shall be extended by the period of such delay.

13.3.2 The performance security shall be denominated in the currency or currencies of the Contract, or in a freely convertible currency acceptable to the EESL, and shall be in the form of unconditional bank guarantee provided in Section-VII (Forms and Procedures)-Form of Performance Security of the bidding documents.

13.3.3 Unless otherwise stipulated in SCC, the security shall be reduced pro rata to the Contract Price of a part of the Facilities for which a separate time for Completion is provided, twenty one (21) months after Completion of the Facilities or where relevant part thereof, or fifteen (15) months after Operational Acceptance of the Facilities (or the relevant part thereof), whichever occurs first; provided, however, that if the Defects Liability Period has been extended on any part of the Facilities pursuant to GCC Sub-Clause 27.8 hereof, the Implementing Partner shall issue an additional security in an amount proportionate to the Contract Price of that part. The security shall be returned to the Implementing Partner immediately after its expiration, provided, however, that if the Implementing Partner, pursuant to GCC Sub-Clause 27.10, is liable for an extended warranty obligation, the performance security shall be extended for the period and up to the amount agreed upon or as specified in the SCC.

14. Taxes and Duties

14.1 Except as otherwise specifically provided in the Contract, the Implementing Partner shall bear and pay all taxes, duties, levies and charges assessed on the Implementing Partner, its Sub-Implementing Partners or their employees by all municipal, state or national government authorities in connection with the Facilities in and outside of the country where the Site is located.

14.2 Notwithstanding GCC Sub-Clauses 14.1 above, the EESL shall bear and promptly reimburse all customs and import duties, if imposed in future, on the Plant and Equipment including Type Test and mandatory spares supplied from abroad and specified in Price Schedule (and on spare parts to be supplied from abroad and specified in Schedule, when awarded) and that are to be incorporated into the Facilities, by the law of the country where the Site is located. However, if the plant and equipment are shipped in Shipper's containers, then the custom duty levied on the cost of empty containers shall be borne and paid/reimbursed by the Implementing Partner. The EESL shall also bear and pay/reimburse to the Implementing Partner/Assignee of Foreign Implementing Partner (if applicable) Sales Tax (but not the surcharge in lieu of Sales Tax), Local Tax including Entry Tax / Octroi (if applicable) in respect of direct transactions between the EESL and the Implementing Partner, if imposed on the Plant and Equipment including Type Test and Mandatory Spares manufactured within the EESL's country and specified in Price (and also on locally supplied spares quoted when awarded) to be incorporated in the Facilities, by the law of country where the site is located. For this purpose, the Ex-works price if quoted in foreign currency and so



incorporated in the contract, shall be converted to Indian Rupees as per the TT buying exchange rates established by State Bank of India prevailing on the actual date of Ex-works (India) despatch.

All taxes, duties and levies on works contract, if any, shall be to the Implementing Partner's account and no separate claim in this regard will be entertained by the EESL.

14.3 If any tax exemptions, reductions, allowances or privileges is available to the Implementing Partner in the country where the Site is located, the EESL shall use its best endeavours to enable the Implementing Partner to benefit from any such tax savings to the maximum allowable extent.

14.4 For the purpose of the Contract, it is agreed that the Contract Price specified in Article 2 (Contract Price and Terms of Payment) of the Contract Agreement is based on the taxes, duties, levies and charges prevailing at the date seven (7) days prior to the last date of bid submission in the country where the Site is located (hereinafter called "Tax" in this GCC Sub-Clause 14.4). If any rates of Tax are increased or de-created, a new Tax is introduced, an existing Tax is abolished, or any change in interpretation or application of any Tax occurs in the course of the performance of Contract, which was or will be assessed on the Implementing Partner in connection with performance of the Contract, an equitable adjustment of the Contract Price shall be made to fully take into account any such change by addition to the Contract Price or deduction there-from, as the case may be, in accordance with GCC Clause 36 (Change in Laws and Regulations) hereof. However, these adjustments would be restricted to direct transactions between the EESL and the Contractor/assignee of Foreign Implementing Partner (if applicable). These adjustments shall not be applicable on procurement of raw materials, intermediary components etc. by the Implementing Partner/assignee and also not applicable on the bought out items despatched directly from sub-vendor's works to site.

D. Intellectual Property

15. Copyright

15.1 The copyright in all drawings, documents and other materials containing data and information furnished to the EESL by the Implementing Partner herein shall remain vested in the Implementing Partner or, if they are furnished to the EESL directly or through the Implementing Partner by any third party, including suppliers of materials, the copyright in such materials shall remain vested in such third party. The EESL shall however be free to reproduce all drawings, documents and other material furnished to the EESL for the purpose of the contract including, if required, for operation and maintenance of the facilities.

16. Confidential Information

16.1 The EESL and the Implementing Partner shall keep confidential and shall not, without the written consent of the other party hereto, divulge to any third party any documents, data or other information furnished directly or indirectly by the other party hereto in connection with the Contract, whether such information has been furnished prior to, during or following termination of the Contract. Notwithstanding the above, the Contractor or Implementing Partner may furnish to its SubContractor or Implementing Partner(s) such documents, data and other information it receives from the EESL to the extent required for the Sub Contractor or Implementing Partner(s) to perform its work under the Contract, in which event the Implementing Partner shall obtain from such SubContractor or Implementing Partner(s) an undertaking of confidentiality similar to that imposed on the Implementing Partner under this GCC Clause 16.

16.2 The EESL shall not use such documents, data and other information received from the Implementing Partner for any purpose other than the operation and maintenance of the Facilities. Similarly, the Implementing Partner shall not use such documents, data and other information received from the EESL for any purpose other than the design, procurement of Plant and Equipment, construction or such other work and services as are required for the performance of the Contract.

16.3 The obligation of a party under GCC Sub-Clauses 16.1 and 16.2 above, however, shall not apply to that information which

- (a) now or hereafter enters the public domain through no fault of that party.
- (b) can be proven to have been possessed by that party at the time of disclosure and which was not previously obtained, directly or indirectly, from the other party hereto
- (c) Otherwise lawfully becomes available to that party from a third party that has no obligation of confidentiality.



16.4 The above provisions of this GCC Clause 16 shall not in any way modify any undertaking of confidentiality given by either of the parties hereto prior to the date of the Contract in respect of the Facilities or any part thereof.

16.5 The provisions of this GCC Clause 16 shall survive termination, for what-ever reason, of the Contract.

E. **Work Execution**

17. Representatives

17.1 Project Manager

If the Project Manager is not named in the Contract, then within fourteen (14) days of the Effective Date, the EESL shall appoint and notify the Implementing Partner in writing of the name of the Project Manager. The EESL may from time to time appoint some other person as the Project Manager in place of the person previously so appointed, and shall give a notice of the name of such other person to the Implementing Partner without delay. The EESL shall take reasonable care to see that no such appointment is made at such a time or in such a manner as to impede the progress of work on the Facilities. The Project Manager shall represent and act for the EESL at all times during the currency of the Contract. All notices, instructions, orders, certificates, approvals and all other communications under the Contract shall be given by the Project Manager, except as herein otherwise provided.

All notices, instructions, information and other communications given by the Implementing Partner to the EESL under the Contract shall be given to the Project Manager, except as herein otherwise provided.

17.2 Contractor's representative & Construction Manager

17.2.1 If the Implementing Partner's Representative is not named in the Contract, then within fourteen (14) days of the Effective Date, the Implementing Partner shall appoint the Implementing Partner's Representative and shall request the EESL in writing to approve the person so appointed. If the EESL makes no objection to the appointment within fourteen (14) days, the Implementing Partner's Representative shall be deemed to have been approved. If the EESL objects to the appointment within fourteen (14) days giving the reason therefor, then the Implementing Partner shall appoint a replacement within fourteen (14) days of such objection, and the foregoing provisions of this GCC Sub-Clause 17.2.1 shall apply thereto.

17.2.2 The Implementing Partner's Representative shall represent and act for the Implementing Partner at all times during the currency of the Contract and shall give to the Project Manager all the Implementing Partner's notices, instructions, information and all other communications under the Contract.

All notices, instructions, information and all other communications given by the EESL or the Project Manager to the Implementing Partner under the Contract shall be given to the Implementing Partner's Representative or, in its absence, its deputy, except as herein otherwise provided.

The Implementing Partner shall not revoke the appointment of the Implementing Partner's Representative without the EESL's prior written con-sent, which shall not be unreasonably withheld. If the EESL consents thereto, the Implementing Partner shall appoint some other per-son as the Implementing Partner's Representative, pursuant to the procedure set out in GCC Sub-Clause 17.2.1

17.2.3 The Implementing Partner's Representative may, subject to the approval of the EESL (which shall not be unreasonably withheld), at any time delegate to any person any of the powers, functions and authorities vested in him or her. Any such delegation may be revoked at any time. Any such delegation or revocation shall be subject to a prior notice signed by the Implementing Partner's Representa-tive, and shall specify the powers, functions and authorities thereby delegated or revoked. No such delegation or revocation shall take effect unless and until a copy thereof has been delivered to the EESL and the Project Manager.

Any act or exercise by any person of powers, functions and authorities so delegated to him or her in accordance with this GCC Sub-Clause 17.2.3 shall be deemed to be an act or exercise by the Implementing Partner's Representative.

17.2.3.1 Notwithstanding anything stated in GCC Sub-clause 17.1 and 17.2.1 above, for the purpose of execution of



contract, the EESL and the Implementing Partner shall finalise and agree to a Contract Co-ordination Procedure and all the communication under the Contract shall be in accordance with such Contract Co-ordination Procedure.

17.2.4 From the commencement of installation of the Facilities at the Site until Operational Acceptance, the Implementing Partner's Representative shall appoint a suitable person as the construction manager (hereinafter referred to as "the Construction Manager"). The Construction Manager shall supervise all work done at the Site by the Implementing Partner and shall be present at the Site throughout normal working hours except when on leave, sick or absent for reasons connected with the proper performance of the Contract. When-ever the Construction Manager is absent from the Site, a suitable person shall be appointed to act as his or her deputy.

17.2.5 The EESL may by notice to the Implementing Partner object to any representative or person employed by the Implementing Partner in the execution of the Contract who, in the reasonable opinion of the EESL, may behave inappropriately, may be incompetent or negligent, or may commit a serious breach of the Site regulations provided under GCC Sub-Clause 22.3. The EESL shall provide evidence of the same, whereupon the Implementing Partner shall remove such person from the Facilities.

17.2.6 If any representative or person employed by the Implementing Partner is removed in accordance with GCC Sub-Clause 17.2.5, the Contractor shall, where required, promptly appoint a replacement.

18. Work Program

18.1 Contractor or Implementing Partner's Organization

The Implementing Partner shall supply to the EESL and the Project Manager a chart showing the proposed organization to be established by the Implementing Partner for carrying out work on the Facilities. The chart shall include the identities of the key personnel together with the curricula vitae of such key personnel to be employed within twenty-one (21) days of the Effective Date. The Implementing Partner shall promptly inform the EESL and the Project Manager in writing of any revision or alteration of such an organization chart.

18.2 Program of Performance

Within twenty-eight (28) days after the date of notification of award of Contract, the Implementing Partner shall prepare and submit to the Project Manager a detailed program of performance of the Contract, made in the form of PERT Network and showing the sequence in which it proposes to design, manufacture, transport, assemble, install and pre-commission the Facilities, as well as the date by which the Implementing Partner reasonably requires that the EESL shall have fulfilled its obligations under the Contract so as to enable the Implementing Partner to execute the Contract in accordance with the program and to achieve Completion and Acceptance of the Facilities in accordance with the Contract. The program so submitted by the Implementing Partner shall accord with the Time Schedule included in Appendix 4 (Time Schedule) to the Contract Agreement and any other dates and periods specified in the Contract. The Implementing Partner shall update and revise the program as and when appropriate or when required by the Project Manager, but without modification in the Time for Completion given in the SCC and any extension granted in accordance with GCC Clause 40, and shall submit all such revisions to the Project Manager.

18.3 Progress Report

The Contractor or Implementing Partner shall monitor progress of all the activities specified in the program referred to in GCC Sub-Clause 18.2 (Program of Performance) above, and supply a progress report to the Project Manager every month.

The progress report shall be in a form acceptable to the Project Manager and shall also indicate: (a) percentage completion achieved compared with the planned percentage completion for each activity; and (b) where any activity is behind the program, giving comments and likely consequences and stating the corrective action being taken.

18.4 Progress of Performance

If at any time the Implementing Partner's actual progress falls behind the program referred to in GCC Sub-Clause 18.2 (Program of Performance), or it becomes apparent that it will so fall behind, the Implementing Partner shall, at the request of the EESL or the Project Manager, prepare and submit to the Project Manager a revised program, taking into account the prevailing circumstances, and shall notify the Project Manager of the steps being taken to expedite progress so as to attain Completion of the Facilities within the Time for Completion under GCC Sub-Clause 8.2 (Time for Commencement and Completion), any extension thereof entitled under GCC Sub-Clause 40.1 (Extension of Time for Completion), or any extended period as may otherwise be agreed upon between the EESL and the Implementing Partner.

18.5 Work Procedures



Signature :
Subject : CN=DEEPAK MITTAL, ST=DELHI, OID.2.5.4.17=110003, OU=CONTRACTS AN
PROCUREMENT, O=ENERGY EFFICIENCY SERVICES LIMITED, C=IN
User ID : deepak.mittal
Serial No : F3FA77

The Contract shall be executed in accordance with the Contract Documents and the procedures given in the section on Forms and Procedures of the Contract Documents.

If agreed between the EESL and the Implementing Partner, the Implementing Partner may execute the Contract in accordance with its own standard project execution plans and procedures to the extent that they do not conflict with the provisions contained in the Contract.

18.6 Maintenance of Records of Weekly Progress Review meeting at Site

The Contractor shall be required to attend all weekly site progress review meetings organised by the 'Project Manager' or his authorised representative. The deliberations in the meetings shall inter alia include the weekly program, progress of work (including details of manpower, tools & plants deployed by the Contractor vis-a-vis agreed schedule), inputs to be provided by Employer, delays, if any and recovery program, specific hindrances to work and work instructions by Employer. The minutes of the weekly meetings shall be recorded in triplicate in a numbered register available with the Project Manager or his authorised representative. These representative and the Contractor and one copy of the signed records shall be handed over to the Contractor.

19. Subcontracting

19.1 Appendix 5 (List of Approved Sub-Implementing Partners) to the Contract Agreement specifies major items of supply or services and a list of approved Sub-Implementing Partners against each item, including vendors. Insofar as no Sub-Implementing Partners are listed against any such item, the Implementing Partner shall prepare a list of Sub-Implementing Partners for such item for inclusion in such list. The Implementing Partner may from time to time propose any addition to or deletion from any such list. The Implementing Partner shall submit any such list or any modification thereto to the EESL for its approval in sufficient time so as not to impede the progress of work on the Facilities. Such approval by the EESL for any of the Sub-Implementing Partners shall not relieve the Implementing Partner from any of its obligations, duties or responsibilities under the Contract.

19.2 The Implementing Partner shall select and employ its Sub-Implementing Partners for such major items from those listed in the lists referred to in GCC Sub-Clause 19.1.

19.3 For items or parts of the Facilities not specified in Appendix 5 (List of Approved Sub-Implementing Partners) to the Contract Agreement, the Implementing Partner may employ such Sub-Implementing Partners as it may select, at its discretion.

20. Design and Engineering

20.1 Specifications and Drawings

20.1.1 The Implementing Partner shall execute the basic and detailed design and the engineering work in compliance with the provisions of the Contract, or where not so specified, in accordance with good engineering practice.

The Implementing Partner shall be responsible for any discrepancies, errors or omissions in the specifications, drawings and other technical documents that it has prepared, whether such specifications, drawings and other documents have been approved by the Project Manager or not, provided that such discrepancies, errors or omissions are not because of inaccurate information furnished in writing to the Implementing Partner by or on behalf of the EESL.

20.1.2 The Implementing Partner shall be entitled to disclaim responsibility for any design, data, drawing, specification or other document, or any modification thereof provided or designated by or on behalf of the EESL, by giving a notice of such disclaimer to the Project Manager.

20.2 Codes and Standards

Wherever references are made in the Contract to codes and standards in accordance with which the Contract shall be executed, the edition or the revised version of such codes and standards current at the date twenty-eight (28) days prior to date of bid submission shall apply unless otherwise specified. During Contract execution, any changes in such codes and standards shall be applied after approval by the EESL and shall be treated in accordance with GCC Clause 39 (Changes Originating from Implementing Partner).

20.3 Approval/Review of Technical Documents by Project Manager, where ever applicable



Signature :-
Subject : CN=DEEPAK MITTAL, ST=DELHI, OID.2.5.4.17=110003, OU=CONTRACTS AND
PROCUREMENT, O=ENERGY EFFICIENCY SERVICES LIMITED, C=IN
User ID : deepak.mittal
Serial No : F3FA77

20.3.1 The Implementing Partner shall prepare (or cause its SubImplementing Partners to prepare) and furnish to the Project Manager the documents listed in Appendix 7 (List of Documents for Approval or Review) to the Contract Agreement for its approval or review as specified and as in accordance with the requirements of GCC Sub-Clause 18.2 (Program of Performance).

Any part of the Facilities covered by or related to the documents to be approved by the Project Manager shall be executed only after the Project Manager's approval thereof.

GCC Sub-Clauses 20.3.2 through 20.3.7 shall apply to those documents requiring the Project Manager's approval, but not to those furnished to the Project Manager for its review only.

20.3.2 Within twenty one (21) days after receipt by the Project Manager of any document requiring the Project Manager's approval in accordance with GCC Sub-Clause 20.3.1, the Project Manager shall either return one copy thereof to the Implementing Partner with its approval endorsed thereon or shall notify the Implementing Partner in writing of its disapproval thereof and the reasons therefor and the modifications that the Project Manager proposes.

20.3.3 The Project Manager shall not disapprove any document, except on the grounds that the document does not comply with some specified provision of the Contract or that it is contrary to good engineering practice.

20.3.4 If the Project Manager disapproves the document, the Implementing Partner shall modify the document and resubmit it for the Project Manager's approval in accordance with GCC Sub-Clause 20.3.2. If the Project Manager approves the document subject to modification(s), the Implementing Partner shall make the required modification(s), and upon resubmission with the required modifications the document shall be deemed to have been approved.

The procedure for submission of the documents by the Implementing Partner and their approval by the Project Manager shall be discussed and finalised with the Implementing Partner.

20.3.5 If any dispute or difference occurs between the EESL and the Implementing Partner in connection with or arising out of the disapproval by the Project Manager of any document and/or any modification(s) thereto that cannot be settled between the parties within a reasonable period, then such dispute or difference may be referred to an Adjudicator for determination in accordance with GCC Sub-Clause 6.1 (Adjudicator) hereof. If such dispute or difference is referred to an Adjudicator, the Project Manager shall give instructions as to whether and if so, how, performance of the Contract is to proceed. The Implementing Partner shall proceed with the Contract in accordance with the Project Manager's instructions, provided that if the Adjudicator upholds the Implementing Partner's view on the dispute and if the EESL has not given notice under GCC Sub-Clause 6.1.2 hereof, then the Implementing Partner shall be reimbursed by the EESL for any additional costs incurred by reason of such instructions and shall be relieved of such responsibility or liability in connection with the dispute and the execution of the instructions as the Adjudicator shall decide, and the Time for Completion shall be extended accordingly.

20.3.6 The Project Manager's approval, with or without modification of the document furnished by the Implementing Partner, shall not relieve the Implementing Partner of any responsibility or liability imposed upon it by any provisions of the Contract except to the extent that any subsequent failure results from modifications required by the Project Manager.

20.3.7 The Implementing Partner shall not depart from any approved document unless the Implementing Partner has first submitted to the Project Manager an amended document and obtained the Project Manager's approval thereof, pursuant to the provisions of this GCC Sub-Clause 20.3.

If the Project Manager requests any change in any already approved document and/or in any document based thereon, the provisions of GCC Clause 39 (Change in the Facilities) shall apply to such request.

21. Procurement

21.1 Plant and Equipment

Subject to GCC Sub-Clause 14.2, the Implementing Partner shall manufacture or procure and transport all the Plant and Equipment in an expeditious and orderly manner to the Site.

21.2 EESL-Supplied Plant, Equipment, and Materials

If Appendix 6 (Scope of Works and Supply by the EESL) to the Contract Agreement provides that the EESL shall furnish any specific items of machinery, equipment or materials to the Implementing Partner, the following provisions shall apply:



Signature :-
Subject : CN=DEEPAK MITTAL, ST=DELHI, OID.2.5.4.17=110003, OU=CONTRACTS AN
PROCUREMENT, O=ENERGY EFFICIENCY SERVICES LIMITED, C=IN
User ID : deepak.mittal
Serial No : F3FA77

21.2.1 The EESL shall, at its own risk and expense, transport each item to the place on or near the Site as agreed upon by the parties and make such item available to the Implementing Partner at the time specified in the program furnished by the Implementing Partner, pursuant to GCC Sub-Clause 18.2 (Program of Performance), unless otherwise mutually agreed.

21.2.2 Upon receipt of such item, the Implementing Partner shall inspect the same visually and notify the Project Manager of any detected shortage, defect or default. The EESL shall immediately remedy any shortage, defect or default, or the Implementing Partner shall, if practicable and possible, at the request of the EESL, remedy such shortage, defect or default at the EESL's cost and expense. After inspection, such item shall fall under the care, custody and control of the Implementing Partner. The provision of this GCC Sub-Clause 21.2.2 shall apply to any item supplied to remedy any such shortage or default or to substitute for any defective item, or shall apply to defective items that have been repaired.

21.2.3 The foregoing responsibilities of the Implementing Partner and its obligations of care, custody and control shall not relieve the EESL of liability for any undetected shortage, defect or default, nor place the Implementing Partner under any liability for any such shortage, defect or default whether under GCC Clause 27 (Defect Liability) or under any other provision of Contract.

21.3 Transportation

21.3.1 The Implementing Partner shall at its own risk and expense transport all the Plant and Equipment and the Implementing Partner's Equipment to the Site by the mode of transport that the Implementing Partner judges most suitable under all the circumstances.

Packing Material

The Contractor shall ensure that all the plant and equipment are suitably packed and protected to prevent damage or deterioration during its transportation to site, handling and storage at site till the time of its installation. The ownership of all such packing material (except empty shipper's containers on which the customs duty has been paid by the Contractor) shall stand transferred to the Employer upon dispatch of the plant and equipment and endorsement of dispatch documents in favour of the Employer.

21.3.2 Unless otherwise provided in the Contract, the Implementing Partner shall be entitled to select any safe mode of transport operated by any person to carry the Plant and Equipment and the Implementing Partner's Equipment.

21.3.3 Upon despatch of each shipment of the Plant and Equipment and the Implementing Partner's Equipment, the Implementing Partner shall notify the EESL by telex, cable, facsimile or Electronic Data Interchange (EDI) of the description of the Plant and Equipment and of the Implementing Partner's Equipment, the point and means of dispatch, and the estimated time and point of arrival in the country where the Site is located, if applicable, and at the Site. The Implementing Partner shall furnish the EESL with relevant shipping documents to be agreed upon between the parties.

21.3.4 The Implementing Partner shall be responsible for obtaining, if necessary, approvals from the authorities for transportation of the Plant and Equipment and the Implementing Partner's Equipment to the Site. The EESL shall use its best endeavors in a timely and expeditious manner to assist the Implementing Partner in obtaining such approvals, if requested by the Implementing Partner. The Implementing Partner shall indemnify and hold harmless the EESL from and against any claim for damage to roads, bridges or any other traffic facilities that may be caused by the transport of the Plant and Equipment and the Implementing Partner's Equipment to the Site.

21.4 Customs Clearance

The Implementing Partner shall, at its own expense, handle all imported Plant and Equipment and Implementing Partner's Equipment at the point(s) of import and shall handle any formalities for customs clearance, subject to the EESL's obligations under GCC Sub-Clause 14.2, provided that if applicable laws or regulations require any application or act to be made by or in the name of the EESL, the EESL shall take all necessary steps to comply with such laws or regulations. In the event of delays in customs clearance due to fault of the EESL, the Implementing Partner shall be entitled to an extension in the Time for Completion, pursuant to GCC Clause 40.

22. Installation



Signature :-
Subject : CN=DEEPAK MITTAL, ST=DELHI, OID.2.5.4.17=110003, OU=CONTRACTS AND
PROCUREMENT, O=ENERGY EFFICIENCY SERVICES LIMITED, C=IN
User ID : deepak.mittal
Serial No : F3FA77

22.1 Setting Out/Supervision/Labour

22.1.1 Bench Mark: The Implementing Partner shall be responsible for the true and proper setting-out of the Facilities in relation to bench marks, reference marks and lines provided to it in writing by or on behalf of the EESL. If, at any time during the progress of installation of the Facilities, any error shall appear in the position, level or alignment of the Facilities, the Implementing Partner shall forthwith notify the Project Manager of such error and, at its own expense, immediately rectify such error to the reasonable satisfaction of the Project Manager. If such error is based on incorrect data provided in writing by or on behalf of the EESL, the expense of rectifying the same shall be borne by the EESL.

22.1.2 Implementing Partner's Supervision: The Implementing Partner shall give or provide all necessary superintendence during the installation of the Facilities, and the Construction Manager or its deputy shall be constantly on the Site to provide full-time superintendence of the installation. The Implementing Partner shall provide and employ only technical personnel who are skilled and experienced in their respective callings and supervisory staff who are competent to adequately supervise the work at hand.

22.1.3 Labour:

- (a) The Implementing Partner shall provide and employ on the Site in the installation of the Facilities such skilled, semi-skilled and unskilled labor as is necessary for the proper and timely execution of the Contract. The Implementing Partner is encouraged to use local labor that has the necessary skills.
- (b) Unless otherwise provided in the Contract, the Implementing Partner shall be responsible for the recruitment, transportation, accommodation and catering of all labor, local or expatriate, required for the execution of the Contract and for all payments in connection therewith.
- (c) The Implementing Partner shall be responsible for obtaining all necessary permit(s) and/or visa(s) from the appropriate authorities for the entry of all labor and personnel to be employed on the Site into the country where the Site is located.
- (d) The Implementing Partner shall at its own expense provide the means of repatriation to all of its and its SubImplementing Partner's personnel employed on the Contract at the Site to their various home countries. It shall also provide suitable temporary maintenance of all such persons from the cessation of their employment on the Contract to the date programmed for their departure. In the event that the Implementing Partner defaults in providing such means of transportation and temporary maintenance, the EESL may provide the same to such personnel and recover the cost of doing so from the Implementing Partner.
- (e) The Implementing Partner shall at all times during the progress of the Contract use its best endeavors to prevent any unlawful, riotous or disorderly conduct or behavior by or amongst its employees and the labor of its SubImplementing Partners.
- (f) The Implementing Partner shall, in all dealings with its labor and the labor of its SubImplementing Partners currently employed on or connected with the Contract, pay due regard to all recognized festivals, official holidays, religious or other customs and all local laws and regulations pertaining to the employment of labor.

22.2 Contractor, Implementing Partner's Equipment

22.2.1 All Contractors or Implementing Partners' Equipment brought by the Implementing Partner onto the Site shall be deemed to be intended to be used exclusively for the execution of the Contract. The Implementing Partner shall not remove the same from the Site without the Project Manager's consent that such Implementing Partner's Equipment is no longer required for the execution of the Contract.

22.2.2 Unless otherwise specified in the Contract, upon completion of the Facilities, the Implementing Partner shall remove from the Site all Equipment brought by the Implementing Partner onto the Site and any surplus materials



remaining thereon.

22.2.3 The EESL will, if requested, use its best endeavours to assist the Implementing Partner in obtaining any local, state or national government permission required by the Implementing Partner for the export of the Implementing Partner's Equipment imported by the Implementing Partner for use in the execution of the Contract that is no longer required for the execution of the Contract.

22.3 Site Regulations and Safety

The EESL and the Implementing Partner shall establish Site regulations setting out the rules to be observed in the execution of the Contract at the Site and shall comply therewith. The Implementing Partner shall prepare and submit to the EESL, with a copy to the Project Manager, proposed Site regulations for the EESL's approval, which approval shall not be unreasonably withheld.

Such Site regulations shall include, but shall not be limited to, rules in respect of security, safety of the Facilities, gate control, sanitation, medical care, and fire prevention.

22.4 Opportunities for Other Implementing Partners

22.4.1 The Implementing Partner shall, upon written request from the EESL or the Project Manager, give all reasonable opportunities for carrying out the work to any other Implementing Partners employed by the EESL on or near the Site.

22.4.2 If the Implementing Partner, upon written request from the EESL or the Project Manager, makes available to other Implementing Partners any roads or ways the maintenance for which the Implementing Partner is responsible, permits the use by such other Implementing Partners of the Implementing Partner's Equipment, or provides any other service of whatsoever nature for such other Implementing Partners, the EESL shall fully compensate the Implementing Partner for any loss or damage caused or occasioned by such other Implementing Partners in respect of any such use or service, and shall pay to the Implementing Partner reasonable remuneration for the use of such equipment or the provision of such services.

22.4.3 The Implementing Partner shall also so arrange to perform its work as to minimize, to the extent possible, interference with the work of other Implementing Partners. The Project Manager shall determine the resolution of any difference or conflict that may arise between the Implementing Partner and other Implementing Partners and the workers of the EESL in regard to their work.

22.4.4 The Implementing Partner shall notify the Project Manager promptly of any defects in the other Implementing Partners' work that come to its notice, and that could affect the Implementing Partner's work. The Project Manager shall determine the corrective measures, if any, required to rectify the situation after inspection of the Facilities. Decisions made by the Project Manager shall be binding on the Implementing Partner.

22.5 Emergency Work

If, by reason of an emergency arising in connection with and during the execution of the Contract, any protective or remedial work is necessary as a matter of urgency to prevent damage to the Facilities, the Implementing Partner shall immediately carry out such work.

If the Implementing Partner is unable or unwilling to do such work immediately, the EESL may do or cause such work to be done as the EESL may determine is necessary in order to prevent damage to the Facilities. In such event the EESL shall, as soon as practicable after the occurrence of any such emergency, notify the Implementing Partner in writing of such emergency, the work done and the reasons therefor. If the work done or caused to be done by the EESL is work that the Implementing Partner was liable to do at its own expense under the Contract, the reasonable costs incurred by the EESL in connection therewith shall be paid by the Implementing Partner to the EESL. Otherwise, the cost of such remedial work shall be borne by the EESL.

22.6 Site Clearance

22.6.1 Site Clearance in Course of Performance: In the course of carrying out the Contract, the Implementing Partner shall keep the Site reasonably free from all unnecessary obstruction, store or remove any surplus materials, clear away any wreckage, rubbish or temporary works from the Site, and remove any Implementing Partner's



Signature :-
Subject : CN=DEEPAK MITTAL, ST=DELHI, OID.2.5.4.17=110003, OU=CONTRACTS AN
PROCUREMENT, O=ENERGY EFFICIENCY SERVICES LIMITED, C=IN
User ID : deepak.mittal
Serial No : F3FA77

Equipment no longer required for execution of the Contract.

22.6.2 Clearance of Site after Completion: After Completion of all parts of the Facilities, the Implementing Partner shall clear away and remove all wreckage, rubbish and debris of any kind from the Site, and shall leave the Site and Facilities clean and safe.

Disposal of Scrap

The Contractor shall with the agreement of the Employer promptly remove from the site any 'Scrap' generated during performance of any activities at site in pursuance of the Contract. The term 'Scrap' shall refer to scrap / waste / remnants arising out of the fabrication of structural steel work and piping work at the project site in the course of execution of the contract and shall also include any wastage of cables during the termination process while installing the cables.

The ownership of such Scrap shall vest with the Contractor except in cases where the items have been issued by the Employer from its stores for their installation only without any adjustment to the Contract Price. The removal of scrap shall be subject to the Contractor producing the necessary clearance from the relevant authorities (Custom, Excise etc.), if required by the law, in respect of disposal of the scrap. The liability for the payment of the applicable taxes/duties shall be that of the Contractor. Harmful scrap shall be disposed as per environmental statutory or other guidelines at contractor or implementing partner own cost.

The Contractor shall also indemnify to keep the Employer harmless from any act of omission or negligence on the part of the Contractor in following the statutory requirements with regard to removal/disposal of scrap. The Indemnity Bond shall be furnished by Contractor as per proforma enclosed in Section-VII (Forms and Procedure) as Form No. 14. Further, in case the laws require the Employer to take prior permission of the relevant Authorities before handing over the scrap to the Contractor, the same shall be obtained by the Contractor on behalf of the Employer.

However scrap generated in say replacement of pumps (i.e. old pumps as scrap) or any other scrap which is owned by EESL as per contract agreement, the same shall be disposed by EESL and EESL will get the payment. Contractor or Implementing Partner will co-ordinate with EESL and the agency picking up the scrap, for scrap disposal.

22.7 Watching and Lighting

The Implementing Partner shall provide and maintain at its own expense all lighting, fencing, and watching when and where necessary for the proper execution and the protection of the Facilities, or for the safety of the owners and occupiers of adjacent property and for the safety of the public.

22.8 Work at Night and on Holidays

22.8.1 Unless otherwise provided in the Contract, no work shall be carried out during the night and on public holidays of the country where the Site is located without prior written consent of the EESL, except where work is necessary or required to ensure safety of the Facilities or for the protection of life, or to prevent loss or damage to property, when the Implementing Partner shall immediately advise the Project Manager, provided that provisions of this GCC Sub-Clause 22.8.1 shall not apply to any work which is customarily carried out by rotary or double-shifts.

22.8.2 Notwithstanding GCC Sub-Clauses 22.8.1 or 22.1.3, if and when the Implementing Partner considers it necessary to carry out work at night or on public holidays so as to meet the Time for Completion and requests the EESL's consent thereto, the EESL shall not unreasonably withhold such consent.

23. Test and Inspection

23.1 The Implementing Partner shall at its own expense carry out at the place of manufacture and/or on the Site all such tests and/or inspections of the Plant and Equipment and any part of the Facilities as are specified in the Contract.

23.2 The EESL and the Project Manager or their designated representatives shall be entitled to attend the aforesaid test and/or inspection, provided that the EESL shall bear all costs and expenses incurred in connection with such attendance including, but not limited to, all traveling and board and lodging expenses.



Signature :-
Subject : CN=DEEPAK MITTAL, ST=DELHI, OID.2.5.4.17=110003, OU=CONTRACTS AN
PROCUREMENT, O=ENERGY EFFICIENCY SERVICES LIMITED, C=IN
User ID : deepak.mittal
Serial No : F3FA77

23.3 Whenever the Implementing Partner is ready to carry out any such test and/or inspection, the Implementing Partner shall give a reasonable advance notice of such test and/or inspection and of the place and time thereof to the Project Manager. The Implementing Partner shall obtain from any relevant third party or manufacturer any necessary permission or consent to enable the EESL and the Project Manager (or their designated representatives) to attend the test and/or inspection.

23.4 The Implementing Partner shall provide the Project Manager with a certified report of the results of any such test and/or inspection.

If the EESL or Project Manager (or their designated representatives) fails to attend the test and/or inspection, or if it is agreed between the parties that such persons shall not do so, then the Implementing Partner may proceed with the test and/or inspection in the absence of such persons, and may provide the Project Manager with a certified report of the results thereof.

23.5 The Project Manager may require the Implementing Partner to carry out any test and/or inspection not required by the Contract, provided that the Implementing Partner's reasonable costs and expenses incurred in the carrying out of such test and/or inspection shall be added to the Contract Price. Further, if such test and/or inspection impedes the progress of work on the Facilities and/or the Implementing Partner's performance of its other obligations under the Contract, due allowance will be made in respect of the Time for Completion and the other obligations so affected.

23.6 If any Plant and Equipment or any part of the Facilities fails to pass any test and/or inspection, the Implementing Partner shall either rectify or replace such Plant and Equipment or part of the Facilities and shall repeat the test and/or inspection upon giving a notice under GCC Sub-Clause 23.3.

23.7 If any dispute or difference of opinion shall arise between the parties in connection with or arising out of the test and/or inspection of the Plant and Equipment or part of the Facilities that cannot be settled between the parties within a reasonable period of time, it may be referred to the Adjudicator for determination in accordance with GCC Sub-Clause 6.1 (Adjudicator).

23.8 The Implementing Partner shall afford the EESL and the Project Manager, at the EESL's expense, access at any reasonable time to any place where the Plant and Equipment are being manufactured or the Facilities are being installed, in order to inspect the progress and the manner of manufacture or installation, provided that the Project Manager shall give the Implementing Partner a reasonable prior notice.

23.9 The Implementing Partner agrees that neither the execution of a test and/or inspection of Plant and Equipment or any part of the Facilities, nor the attendance by the EESL or the Project Manager, nor the issue of any test certificate pursuant to GCC Sub-Clause 23.4, shall release the Implementing Partner from any other responsibilities under the Contract.

23.10 No part of the Facilities or foundations shall be covered up on the Site without the Implementing Partner carrying out any test and/or inspection required under the Contract. The Implementing Partner shall give a reasonable notice to the Project Manager whenever any such part of the Facilities or foundations are ready or about to be ready for test and/or inspection; such test and/or inspection and notice thereof shall be subject to the requirements of the Contract.

23.11 The Implementing Partner shall uncover any part of the Facilities or foundations, or shall make openings in or through the same as the Project Manager may from time to time require at the Site, and shall reinstate and make good such part or parts.

If any part of the Facilities or foundations have been covered up at the Site after compliance with the requirement of GCC Sub-Clause 23.10 and are found to be executed in accordance with the Contract, the expenses of uncovering, making openings in or through, reinstating, and making good the same shall be borne by the EESL, and the Time for Completion shall be reasonably adjusted to the extent that the Implementing Partner has thereby been delayed or impeded in the performance of any of its obligations under the Contract.

24. Completion of the Facilities

24.1 As soon as the Facilities or any part thereof has, in the opinion of the Implementing Partner, been completed



Signature :-
Subject : CN=DEEPAK MITTAL, ST=DELHI, OID.2.5.4.17=110003, OU=CONTRACTS AN
PROCUREMENT, O=ENERGY EFFICIENCY SERVICES LIMITED, C=IN
User ID : deepak.mittal
Serial No : F3FA77

operationally and structurally and put in a tight and clean condition as specified in the Technical Specifications, excluding minor items not materially affecting the operation or safety of the Facilities, the Implementing Partner shall so notify the EESL in writing.

24.2 Within seven (7) days after receipt of the notice from the Implementing Partner under GCC Sub-Clause 24.1, the EESL shall supply the operating and maintenance personnel specified in Appendix 6 (Scope of Works and Supply by the EESL) to the Contract Agreement, required for Precommissioning of the Facilities or any part thereof.

Unless otherwise specified in the Technical Specifications, the EESL shall also provide, within the said seven (7) day period, the raw materials, utilities, lubricants, chemicals, catalysts, facilities, services and other matters required for Precommissioning of the Facilities or any part thereof.

24.3 As soon as reasonably practicable after the operating and maintenance personnel have been supplied by the EESL and the raw materials, utilities, lubricants, chemicals, catalysts, facilities, services and other matters, if so specified in Appendix 6 (Scope of Works and Supply by the EESL)/ Technical Specifications, have been provided by the EESL in accordance with GCC Sub-Clause 24.2, the Implementing Partner shall commence Precommissioning of the Facilities or the relevant part thereof in preparation for Commissioning.

24.4 As soon as all works in respect of Precommissioning are completed and, in the opinion of the Implementing Partner, the Facilities or any part thereof is ready for Commissioning, the Implementing Partner shall commence Commissioning as per procedures stipulated in Technical Specifications, and as soon as Commissioning is satisfactorily completed, the Implementing Partner shall so notify the Project Manager in writing.

24.5 The Project Manager shall, within fourteen (14) days after receipt of the Implementing Partner's notice under GCC Sub-Clause 24.4, either issue a Completion Certificate in the form specified in the Forms and Procedures section in the bidding documents, stating that the Facilities or that part thereof have reached Completion as at the date of the Implementing Partner's notice under GCC Sub-Clause 24.4, or notify the Implementing Partner in writing of any defects and/or deficiencies.

If the Project Manager notifies the Implementing Partner of any defects and/or deficiencies, the Implementing Partner shall then correct such defects and/or deficiencies, and shall repeat the procedure described in GCC Sub Clause 24.4.

If the Project Manager is satisfied that the Facilities or that part thereof have reached Completion, the Project Manager shall, within seven (7) days after receipt of the Implementing Partner's repeated notice, issue a Completion Certificate stating that the Facilities or that part thereof have reached Completion as at the date of the Implementing Partner's repeated notice.

If the Project Manager is not so satisfied, then it shall notify the Implementing Partner in writing of any defects and/or deficiencies within seven (7) days after receipt of the Implementing Partner's repeated notice, and the above procedure shall be repeated.

24.6 If the Project Manager fails to issue the Completion Certificate and fails to inform the Implementing Partner of any defects and/or deficiencies within fourteen (14) days after receipt of the Implementing Partner's notice under GCC Sub-Clause 24.4 or within seven (7) days after receipt of the Implementing Partner's repeated notice under GCC Sub-Clause 24.5, or if the EESL makes use of the Facilities or part thereof, then the Facilities or that part thereof shall be deemed to have reached Completion as of the date of the Implementing Partner's notice or repeated notice, or as of the EESL's use of the Facilities, as the case may be.

24.7 As soon as possible after Completion, the Implementing Partner shall complete all outstanding minor items so that the Facilities are fully in accordance with the requirements of the Contract, failing which the EESL will undertake such completion and deduct the costs thereof from any monies owing to the Implementing Partner.

24.8 Upon Completion, the EESL shall be responsible for the care and custody of the Facilities or the relevant part thereof, together with the risk of loss or damage thereto, and shall thereafter take over the Facilities or the relevant part thereof.

25. Commissioning, Guarantee Test and Operational Acceptance

25.1 Commissioning



Signature :-
Subject : CN=DEEPAK MITTAL, ST=DELHI, OID.2.5.4.17=110003, OU=CONTRACTS AND
PROCUREMENT, O=ENERGY EFFICIENCY SERVICES LIMITED, C=IN
User ID : deepak.mittal
Serial No : F3FA77

25.1.1 Commissioning of the Facilities or any part thereof shall be completed by the Implementing Partner as per procedures detailed in the Technical Specifications.

The EESL shall, unless otherwise specified in Appendix 6 (Scope of Works and Supply by the EESL)/ Technical Specifications, supply the operating and maintenance personnel and all raw materials, utilities, lubricants, chemicals, catalysts, facilities, services and other matters required for Commissioning of the Facilities.

25.2 Guarantee Test (where ever applicable)

25.2.1 The Guarantee Test (and repeats thereof) shall be conducted by the Implementing Partner after Commissioning of the Facilities or the relevant part thereof to ascertain whether the Facilities or the relevant part can attain the Functional Guarantees specified in the Contract Documents. The Implementing Partner's and Project Manager's advisory personnel shall attend the Guarantee Test. The EESL shall promptly provide the Implementing Partner with such information as the Implementing Partner may reasonably require in relation to the conduct and results of the Guarantee Test (and any repeats thereof).

25.2.2 If for reasons not attributable to the Implementing Partner, the Guarantee Test of the Facilities or the relevant part thereof cannot be successfully completed within the period from the date of Completion specified in the SCC or any other period agreed upon by the EESL and the Implementing Partner, the Implementing Partner shall be deemed to have fulfilled its obligations with respect to the Functional Guarantees, and GCC Sub-Clauses 28.2 and 28.3 shall not apply.

25.3 Operational Acceptance

25.3.1 Subject to GCC Sub-Clause 25.4 (Partial Acceptance) below, Operational Acceptance shall occur in respect of the Facilities or any part thereof when

- (a) the Guarantee Test has been successfully completed and the Functional Guarantees are met; or
- (b) the Guarantee Test has not been successfully completed or has not been carried out for reasons not attributable to the Implementing Partner within the period from the date of Completion specified in the SCC or any other agreed upon period as specified in GCC Sub-Clause 25.2.2 above, but successful Completion of the Facilities has been achieved; or
- (c) the Implementing Partner has paid the liquidated damages specified in GCC Sub-Clause 28.3 hereof; and
- (d) any minor items mentioned in GCC Sub-Clause 24.7 hereof relevant to the Facilities or that part thereof have been completed.

25.3.2 At any time after any of the events set out in GCC Sub-Clause 25.3.1 have occurred, the Implementing Partner may give a notice to the Project Manager requesting the issue of an Operational Acceptance Certificate in the form provided in the Bidding Documents or in another form acceptable to the EESL in respect of the Facilities or the part thereof specified in such notice as at the date of such notice.

25.3.3 The Project Manager shall, after consultation with the EESL, and within forty five (45) days after receipt of the Implementing Partner's notice, issue an Operational Acceptance Certificate.

25.3.4 If within forty five (45) days after receipt of the Implementing Partner's notice, the Project Manager fails to issue the Operational Acceptance Certificate or fails to inform the Implementing Partner in writing of the justifiable reasons why the Project Manager has not issued the Operational Acceptance Certificate, the Facilities or the relevant part thereof shall be deemed to have been accepted as at the date of the Implementing Partner's said notice.

25.4 Partial Acceptance

25.4.1 If the Contract specifies that Completion and Commissioning shall be carried out in respect of parts of the Facilities, the provisions relating to Completion and Commissioning including the Guarantee Test shall apply to each such part of the Facilities individually, and the Operational Acceptance Certificate shall be issued accordingly for each such part of the Facilities.

25.4.2 If a part of the Facilities comprises facilities such as buildings, for which no Commissioning or Guarantee Test



is required, then the Project Manager shall issue the Operational Acceptance Certificate for such facility when it attains Completion, provided that the Implementing Partner shall thereafter complete any outstanding minor items that are listed in the Operational Acceptance Certificate.

F. Guarantees and Liabilities

26. Completion Time Guarantee

26.1 The Implementing Partner guarantees that it shall attain Completion of the Facilities (or a part for which a separate time for completion is specified in the SCC) within the Time for Completion specified in the SCC pursuant to GCC Sub-Clause 8.2, or within such extended time to which the Implementing Partner shall be entitled under GCC Clause 40 (Extension of Time for Completion) hereof.

26.2 If the Implementing Partner fails to attain Completion of the Facilities or any part thereof within the Time for Completion or any extension thereof under GCC Clause 40 (Extension of Time for Completion), the Implementing Partner shall pay to the EESL liquidated damages in the amount computed at the rates specified in the SCC. The aggregate amount of such liquidated damages shall in no event exceed the amount specified as "Maximum" in the SCC. Once the "Maximum" is reached, the EESL may consider termination of the Contract, pursuant to GCC Sub-Clause 42.2.2.

Such payment shall completely satisfy the Implementing Partner's obligation to attain Completion of the Facilities or the relevant part thereof within the Time for Completion or any extension thereof under GCC Clause 40 (Extension of Time for Completion). The Implementing Partner shall have no further liability whatsoever to the EESL in respect thereof.

However, the payment of liquidated damages shall not in any way relieve the Implementing Partner from any of its obligations to complete the Facilities or from any other obligations and liabilities of the Implementing Partner under the Contract.

Save for liquidated damages payable under this GCC Sub-Clause 26.2, the failure by the Implementing Partner to attain any milestone or other act, matter or thing by any date specified in Appendix 4 (Time Schedule) to the Contract Agreement and/or other program of work prepared pursuant to GCC Clause 18 (Program of Performance) shall not render the Implementing Partner liable for any loss or damage thereby suffered by the EESL.

27. Defect Liability

27.1 The Implementing Partner warrants that the Facilities or any part thereof shall be free from defects in the design, engineering, materials and workmanship of the Plant and Equipment supplied and of the work executed.

27.2 The Defect Liability Period shall be eighteen (18) months from the date of Completion of the Facilities (or any part thereof) or twelve (12) months from the date of Operational Acceptance of the Facilities (or any part thereof), whichever first occurs, unless specified otherwise in the SCC.

If during the Defect Liability Period any defect should be found in the design, engineering, materials and workmanship of the Plant and Equipment supplied or of the work executed by the Implementing Partner, the Implementing Partner shall promptly, in consultation and agreement with the EESL regarding appropriate remedying of the defects, and at its cost, repair, replace or otherwise make good (as the Implementing Partner shall, at its discretion, determine) such defect as well as any damage to the Facilities caused by such defect. The Implementing Partner shall not be responsible for the repair, replacement or making good of any defect or of any damage to the Facilities arising out of or resulting from any of the following causes:

- (a) improper operation or maintenance of the Facilities by the EESL
- (b) operation of the Facilities outside specifications provided in the Contract.
- (c) Normal wear and tear.

27.3 The Implementing Partner's obligations under this GCC Clause 27 shall not apply to

- (a) any materials that are supplied by the EESL under GCC Sub-Clause 21.2 (EESL-Supplied Plant, Equipment and Materials), are normally consumed in operation, or have a normal life shorter than the Defect Liability Period stated herein.



Signature :-
Subject : CN=DEEPAK MITTAL, ST=DELHI, OID.2.5.4.17=110003, OU=CONTRACTS AND
PROCUREMENT, O=ENERGY EFFICIENCY SERVICES LIMITED, C=IN
User ID : deepak.mittal
Serial No : F3FA77

- (b) any designs, specifications or other data designed, supplied or specified by or on behalf of the EESL or any matters for which the Implementing Partner has disclaimed responsibility herein.
- (c) any other materials supplied or any other work executed by or on behalf of the EESL, except for the work executed by the EESL under GCC Sub-Clause 27.7.

27.4 The EESL shall give the Implementing Partner a notice stating the nature of any such defect together with all available evidence thereof, promptly following the discovery thereof. The EESL shall afford all reasonable opportunity for the Implementing Partner to inspect any such defect.

27.5 The EESL shall afford the Implementing Partner all necessary access to the Facilities and the Site to enable the Implementing Partner to perform its obligations under this GCC Clause 27.

The Implementing Partner may, with the consent of the EESL, remove from the Site any Plant and Equipment or any part of the Facilities that are defective if the nature of the defect, and/or any damage to the Facilities caused by the defect, is such that repairs cannot be expeditiously carried out at the Site.

27.6 If the repair, replacement or making good is of such a character that it may affect the efficiency of the Facilities or any part thereof, the EESL may give to the Implementing Partner a notice requiring that tests of the defective part of the Facilities shall be made by the Implementing Partner immediately upon completion of such remedial work, whereupon the Implementing Partner shall carry out such tests.

If such part fails the tests, the Implementing Partner shall carry out further repair, replacement or making good (as the case may be) until that part of the Facilities passes such tests. The tests in character shall in any case be not less than what has already been agreed by the EESL and the Implementing Partner for the original equipment/part of the Facilities.

27.7 If the Implementing Partner fails to commence the work necessary to remedy such defect or any damage to the Facilities caused by such defect within a reasonable time (which shall in no event be considered to be less than fifteen (15) days), the EESL may, following notice to the Implementing Partner, proceed to do such work, and the reasonable costs incurred by the EESL in connection therewith shall be paid to the EESL by the Implementing Partner or may be deducted by the EESL from any monies due to the Implementing Partner or claimed under the Performance Security.

27.8 If the Facilities or any part thereof cannot be used by reason of such defect and/or making good of such defect, the Defect Liability Period of the Facilities or such part, as the case may be, shall be extended by a period equal to the period during which the Facilities or such part cannot be used by the EESL because of any of the aforesaid reasons. Upon correction of the defects in the Facilities or any part thereof by repair/ replacement, such repair/replacement shall have the Defect Liability Period extended by a period of twelve (12) month from the time such replacement/ repair of the Facilities or any part thereof.

27.9 Except as provided in GCC Clauses 27 and 33 (Loss of or DamagetoProperty / Accident or Injury to Workers/Indemnification), the Implementing Partnershall be under no liability whatsoever and howsoever arising, and whetherunder the Contract or at law, in respect of defects in the Facilities or anypart thereof, the Plant and Equipment, design or engineering or workexecuted that appear after Completion of the Facilities or any part thereof,except where such defects are the result of the grossnegligence ,fraud, criminal or wilful action of the Implementing Partner.

27.10 In addition, the Implementing Partner shall also provide an extended warranty for any such component of the Facilities and during the period of time as may be specified in the SCC. Such obligation shall be in addition to the defect liability specified under GCC Sub-Clause 27.2.

28. Functional Guarantees

28.1 The Implementing Partner guarantees that during the Guarantee Test, the Facilities and all parts thereof shall attain the Functional Guarantees specified in Appendix 8 (Functional Guarantees) to the Contract Agreement, subject to and upon the conditions therein specified.

28.2 If, for reasons attributable to the Implementing Partner, the guaranteed level of the Functional Guarantees specified in Appendix 8 (Functional Guarantees) to the Contract Agreement are not met either in whole or in part, the



Signature :-
Subject : CN=DEEPAK MITTAL, ST=DELHI, OID.2.5.4.17=110003, OU=CONTRACTS AN
PROCUREMENT, O=ENERGY EFFICIENCY SERVICES LIMITED, C=IN
User ID : deepak.mittal
Serial No : F3FA77

Implementing Partner shall, within a mutually agreed time, at its cost and expense make such changes, modifications and/or additions to the Plant or any part thereof as may be necessary to meet such Guarantees. The Implementing Partner shall notify the EESL upon completion of the necessary changes, modifications and/or additions, and shall seek the EESL's consent to repeat the Guarantee Test. If the specified Functional Guarantees are not established even during the repeat of the Guarantee Test, the EESL may at its option, either

- (a) Reject the Equipment and recover the payments already made, or
- (b) Terminate the Contract pursuant to GCC Sub-Clause 42.2.2 and recover the payments already made, or
- (c) Accept the equipment after levy of liquidated damages in accordance with the provisions specified in Appendix-8 (Functional Guarantees) to the Contract Agreement.

28.3 In case the EESL exercises its option to accept the equipment after levy of liquidated damages, the payment of liquidated damages under GCC Sub-Clause 28.2, up to the limitation of liability specified in the Appendix-8 (Functional Guarantees) to the Contract Agreement, shall completely satisfy the Implementing Partner's guarantees under GCC Sub-Clause 28.2, and the Implementing Partner shall have no further liability whatsoever to the EESL in respect thereof. Upon the payment of such liquidated damages by the Implementing Partner, the Project Manager shall issue the Operational Acceptance Certificate for the Facilities or any part thereof in respect of which the liquidated damages have been so paid.

29. Patent Indemnity

29.1 The Implementing Partner shall, subject to the EESL's compliance with GCC Sub-Clause 29.2, indemnify and hold harmless the EESL and its employees and officers from and against any and all suits, actions or administrative proceedings, claims, demands, losses, damages, costs, and expenses of whatsoever nature, including attorney's fees and expenses, which the EESL may suffer as a result of any infringement or alleged infringement of any patent, utility model, registered design, trademark, copyright or other intellectual property right registered or otherwise existing at the date of the Contract by reason of: (a) the installation of the Facilities by the Implementing Partner or the use of the Facilities in the country where the Site is located; and (b) the sale of the products produced by the Facilities in any country.

Such indemnity shall not cover any use of the Facilities or any part thereof other than for the purpose indicated by or to be reasonably inferred from the Contract, any infringement resulting from the use of the Facilities or any part thereof, or any products produced thereby in association or combination with any other equipment, plant or materials not supplied by the Implementing Partner, pursuant to the Contract Agreement.

29.2 If any proceedings are brought or any claim is made against the EESL arising out of the matters referred to in GCC Sub-Clause 29.1, the EESL shall promptly give the Implementing Partner a notice thereof, and the Implementing Partner may at its own expense and in the EESL's name conduct such proceedings or claim and any negotiations for the settlement of any such proceedings or claim.

If the Implementing Partner fails to notify the EESL within twenty-eight (28) days after receipt of such notice that it intends to conduct any such proceedings or claim, then the EESL shall be free to conduct the same on its own behalf. Unless the Implementing Partner has so failed to notify the EESL within the twenty-eight (28) day period, the EESL shall make no admission that may be prejudicial to the defense of any such proceedings or claim.

The EESL shall, at the Implementing Partner's request, afford all available assistance to the Implementing Partner in conducting such proceedings or claim, and shall be reimbursed by the Implementing Partner for all reasonable expenses incurred in so doing.

29.3 The EESL shall indemnify and hold harmless the Implementing Partner and its employees, officers and Sub-Implementing Partners from and against any and all suits, actions or administrative proceedings, claims, demands, losses, damages, costs, and expenses of whatsoever nature, including attorney's fees and expenses, which the Implementing Partner may suffer as a result of any infringement or alleged infringement of any patent, utility model, registered design, trademark, copyright or other intellectual property right registered or otherwise existing at the date of the Contract arising out of or in connection with any design, data, drawing, specification, or other documents or materials provided or designed by or on behalf of the EESL.

30. Limitation of Liability

30.1 Except in cases of criminal negligence or wilful misconduct,



Signature :-
Subject : CN=DEEPAK MITTAL, ST=DELHI, OID.2.5.4.17=110003, OU=CONTRACTS AN
PROCUREMENT, O=ENERGY EFFICIENCY SERVICES LIMITED, C=IN
User ID : deepak.mittal
Serial No : F3FA77

- (a) the Implementing Partner shall not be liable to the EESL, whether incontract, tort, or otherwise, for any indirect or consequential lossor damage, loss of use, loss of production, or loss of profits or interest costs, provided that this exclusion shall not apply to anyobligation of the Implementing Partner to pay liquidated damages to theEESL and
- (b) the aggregate liability of the Implementing Partner to the EESL, whetherunder the Contract, in tort or otherwise, shall not exceed the totalContract Price, provided that this limitation shall not apply to anyobligation of the Implementing Partner to indemnify the EESL with respectto patent infringement or as specified in SCC.

G. Risk Distribution

31. Transfer of Ownership

31.1Ownership of the Plant and Equipment (including spare parts) procured in the country where the Site is located shall be transferred to the EESL when the Plant and Equipment are reached at site.

31.2Ownership of the Implementing Partner's Equipment used by the Implementing Partnerand itsSubImplementing Partners in connection with the Contract shall remain with theImplementing Partner or its SubImplementing Partners.

31.3Ownership of any Plant and Equipment in excess of the requirements for the Facilities shall revert to the Implementing Partner upon Completion of the Facilities or at such earlier time when the EESL and the Implementing Partner agree that the Plant and Equipment in question are no longer required for the Facilities, provided quantity of any Plant and Equipment specifically stipulated in the Contract shall be the property of the EESL whether or not incorporated in the Facilities.

31.4 Disposal of surplus material

Ownership of any Plant and Equipment in excess of the requirements for the Facilities (i.e. surplus material) shall revert to the Contractor upon Completion of the Facilities and Guarantee Test or at such earlier time when the Employer and the Contractor agree that the Plant and Equipment in question are no longer required for the Facilities, provided quantity of any Plant and Equipment specifically stipulated in the Contract shall be the property of the Employer whether or not incorporated in the Facilities. The Contractor shall remove from the site such surplus material brought by him in pursuance of the Contract, subject to the Contractor producing the necessary clearance from the relevant authorities (Customs, Excise etc.), if required by law, in respect of re-export or disposal of the surplus material locally. The liability for the payment of the applicable taxes/ duties, if any, on the surplus material so re-exported and/or disposed locally shall be that of the Contractor.

The Contractor shall also indemnify to keep the Employer harmless from any act of omission or negligence on the part of the Contractor in following the statutory requirements with regard to removal / disposal of surplus material. The Indemnity Bond shall be furnished by contractor as per proforma enclosed in Section-VII (Forms and Procedure) as Form No. 14. Further, in case the laws require the Employer to take prior permission of the relevant Authorities before handing over the surplus material to the Contractor, the same shall be obtained by the Contractor on behalf of the Employer.

31.5 Notwithstanding the transfer of ownership of the Plant and Equipment, the responsibility for care and custody thereof together with the risk, of loss or damage thereto shall remain with the Implementing Partner pursuant to GCC Clause 32 (Care of Facilities) hereof until Completion of the Facilities or the part thereof in which such Plant and Equipment are incorporated.

31.5 In case of two/three Contracts entered into between the EESL and the Implementing Partner as per GCC Sub-Clause 3.6 or where the EESL hands over his equipment to the Implementing Partner for executing the Contract, then the Implementing Partner shall at the time of taking delivery of the Equipment through Bill of Lading or other despatch documents furnish Trust Receipt for Plant, Equipment and Materials and also execute an Indemnity Bond in favour of the EESL in the form acceptable to EESL for keeping the equipment in safe custody and to utilise the same exclusively for the purpose of the said Contract. Proforma for the Trust Receipt and Indemnity bond. TheEESL shall also issue a separate Authorisation Letter to the Implementing Partnerto enable him to take physical delivery of plant, equipment and materials from the EESL.



Signature :-
Subject : CN=DEEPAK MITTAL, ST=DELHI, OID.2.5.4.17=110003, OU=CONTRACTS AN
PROCUREMENT, O=ENERGY EFFICIENCY SERVICES LIMITED, C=IN
User ID : deepak.mittal
Serial No : F3FA77

32 Care of Facilities

32.1 The Implementing Partner shall be responsible for the care and custody of the Facilities or any part thereof until the date of Completion of the Facilities pursuant to GCC Clause 24 (Completion of the Facilities) or, where the Contract provides for Completion of the Facilities in parts, until the date of Completion of the relevant part, and shall make good at its own cost any loss or damage that may occur to the Facilities or the relevant part thereof from any cause whatsoever during such period. The Implementing Partner shall also be responsible for any loss or damage to the Facilities caused by the Implementing Partner or its SubImplementing Partners in the course of any work carried out, pursuant to GCC Clause 27 (Defect Liability). Notwithstanding the foregoing, the Implementing Partner shall not be liable for any loss or damage to the Facilities or that part thereof caused by reason of any of the matters specified or referred to in paragraphs (a), (b) and (c) of GCC Sub-Clauses 32.2 and 38.1.

32.2 If any loss or damage occurs to the Facilities or any part thereof or to the Implementing Partner's temporary facilities by reason of

- (a) (insofar as they relate to the country where the Site is located) nuclear reaction, nuclear radiation, radioactive contamination, pressure wave caused by aircraft or other aerial objects, or any other occurrences that an experienced Implementing Partner could not reasonably foresee, or if reasonably foreseeable could not reasonably make provision for or insure against, insofar as such risks are not normally insurable on the insurance market and are mentioned in the general exclusions of the policy of insurance, including War Risks and Political Risks, taken out under GCC Clause 34 (Insurance) hereof.
- (b) any use or occupation by the EESL or any third party (other than a SubImplementing Partner) authorized by the EESL of any part of the Facilities.
- (c) any use of or reliance upon any design, data or specification provided or designated by or on behalf of the EESL, or any such matter for which the Implementing Partner has disclaimed responsibility herein,

the EESL shall pay to the Implementing Partner all sums payable in respect of the Facilities executed, notwithstanding that the same be lost, destroyed or damaged, and will pay to the Implementing Partner the replacement value of all temporary facilities and all parts thereof lost, destroyed or damaged. If the EESL requests the Implementing Partner in writing to make good any loss or damage to the Facilities thereby occasioned, the Implementing Partner shall make good the same at the cost of the EESL in accordance with GCC Clause 39 (Change in the Facilities). If the EESL does not request the Implementing Partner in writing to make good any loss or damage to the Facilities thereby occasioned, the EESL shall either request a change in accordance with GCC Clause 39 (Change in the Facilities), excluding the performance of that part of the Facilities thereby lost, destroyed or damaged, or, where the loss or damage affects a substantial part of the Facilities, the EESL shall terminate the Contract pursuant to GCC Sub-Clause 42.1 (Termination for EESL's Convenience) hereof, except that the Implementing Partner shall have no entitlement to profit under paragraph (e) of GCC Sub-Clause 42.1.3 in respect of any unexecuted Facilities as at the date of termination.

32.3 The Implementing Partner shall be liable for any loss of or damage to any Implementing Partner's Equipment, or any other property of the Implementing Partner used or intended to be used for purposes of the Facilities, except (i) as mentioned in GCC Sub-Clause 32.2 (with respect to the Implementing Partner's temporary facilities), and (ii) where such loss or damage arises by reason of any of the matters specified in GCC Sub-Clauses 32.2(b) and (c) and 38.1.

32.3 With respect to any loss or damage caused to the Facilities or any part thereof or to the Implementing Partner's Equipment by reason of any of the matters specified in GCC Sub-Clause 38.1, the provisions of GCC Sub-Clause 38.3 shall apply.

33 Loss of or Damage to Property; Accident or Injury to workers; Indemnification

33.1 Subject to GCC Sub - Clause 33.3, the Implementing Partner shall indemnify and hold harmless the EESL and its employees and officers from and against any and all suits, actions or administrative proceedings, claims, demands, losses, damages, costs, and expenses of whatsoever nature, including attorney's fees and expenses, in respect of the death or injury of any person or loss of or damage to any property (other than the Facilities whether accepted or not), arising in connection with the supply and installation of the Facilities and by reason of the negligence of the Implementing Partner or its SubImplementing Partners, or their employees, officers or agents, except any injury, death or property damage caused by the negligence of the EESL, its Implementing Partners, employees, officers or agents.

33.2 If any proceedings are brought or any claim is made against the EESL that might subject the Implementing Partner to liability under GCC Sub-Clause 33.1, the EESL shall promptly give the Implementing Partner a notice



thereof and the Implementing Partner may at its own expense and in the EESL's name conduct such proceedings or claim and any negotiations for the settlement of any such proceedings or claim.

If the Implementing Partner fails to notify the EESL within twenty-eight (28) days after receipt of such notice that it intends to conduct any such proceedings or claim, then the EESL shall be free to conduct the same on its own behalf. Unless the Implementing Partner has so failed to notify the EESL within the twenty-eight (28) day period, the EESL shall make no admission that may be prejudicial to the defense of any such proceedings or claim.

The EESL shall, at the Implementing Partner's request, afford all available assistance to the Implementing Partner in conducting such proceedings or claim, and shall be reimbursed by the Implementing Partner for all reasonable expenses incurred in so doing.

33.3 The EESL shall indemnify and hold harmless the Implementing Partner and its employees, officers and Sub-Implementing Partners from any liability for loss of or damage to property of the EESL, other than the Facilities not yet taken over, that is caused by fire, explosion or any other perils, in excess of the amount recoverable from insurances procured under GCC Clause 34 (Insurances), provided that such fire, explosion or other perils were not caused by any act or failure of the Implementing Partner.

33.4 The party entitled to the benefit of an indemnity under this GCC Clause 33 shall take all reasonable measures to mitigate any loss or damage which has occurred. If the party fails to take such measures, the other party's liabilities shall be correspondingly reduced.

34 Insurance

34.1 To the extent specified in Appendix 3 (Insurance Requirements) to the Contract Agreement, the Implementing Partner shall at its expense take out and maintain in effect, or cause to be taken out and maintained in effect, during the performance of the Contract, the insurances set forth below in the sums and with the deductibles and other conditions specified in the said Appendix. The identity of the insurers and the form of the policies shall be subject to the approval of the EESL, who should not unreasonably withhold such approval.

(a) Cargo Insurance During Transport

Covering loss or damage occurring while in transit from the Implementing Partner's or Sub-Implementing Partner's works or stores until arrival at the Site, to the Plant and Equipment (including spare parts therefor) and to the Implementing Partner's Equipment.

(b) Installation All Risks Insurance

Covering physical loss or damage to the Facilities at the Site, occurring prior to Completion of the Facilities, with an extended maintenance coverage for the Implementing Partner's liability in respect of any loss or damage occurring during the Defect Liability Period while the Implementing Partner is on the Site for the purpose of performing its obligations during the Defect Liability Period.

(c) Third Party Liability Insurance

Covering bodily injury or death suffered by third parties (including the EESL's personnel) and loss of or damage to property occurring in connection with the supply and installation of the Facilities.

(d) Automobile Liability Insurance

Covering use of all vehicles used by the Implementing Partner or its Sub-Implementing Partners (whether or not owned by them) in connection with the execution of the Contract.

(e) Workers' Compensation

In accordance with the statutory requirements applicable in any country where the Contract or any part thereof is executed.

(f) EESL's Liability

In accordance with the statutory requirements applicable in any country where the Contract or any part thereof is executed.

(g) Other Insurances

Such other insurances as may be specifically agreed upon by the parties hereto as listed in the said Appendix 3.

34.2 The EESL shall be named as co-insured under all insurance policies taken out by the Implementing Partner



pursuant to GCC Sub-Clause 34.1, except for the Third Party Liability, Workers' Compensation and EESL's Liability Insurances, and the Implementing Partner's SubImplementing Partners shall be named as co-insured's under all insurance policies taken out by the Implementing Partner pursuant to GCC Sub-Clause 34.1 except for the Cargo Insurance During Transport, Workers' Compensation and EESL's Liability Insurances. All insurers' rights of subrogation against such co-insured's for losses or claims arising out of the performance of the Contract shall be waived under such policies.

34.3 The Implementing Partner shall, in accordance with the provisions of Appendix 3 (Insurance Requirements) to the Contract Agreement, deliver to the EESL certificates of insurance (or copies of the insurance policies) as evidence that the required policies are in full force and effect. The certificates shall provide that no less than twenty-one (21) days' notice shall be given to the EESL by insurers prior to cancellation or material modification of a policy.

34.4 The Implementing Partner shall ensure that, where applicable, its SubImplementing Partner(s) shall take out and maintain in effect adequate insurance policies for their personnel and vehicles and for work executed by them under the Contract, unless such SubImplementing Partners are covered by the policies taken out by the Implementing Partner.

34.5 The EESL shall at its expense take out and maintain in effect during the performance of the Contract those insurances specified in Appendix 3 (Insurance Requirements) to the Contract Agreement.

34.6 If the Implementing Partner fails to take out and/or maintain in effect the insurances referred to in GCC Sub-Clause 34.1, the EESL may take out and maintain in effect any such insurances and may from time to time deduct from any amount due the Implementing Partner under the Contract any premium that the EESL shall have paid to the insurer, or may otherwise recover such amount as a debt due from the Implementing Partner. If the EESL fails to take out and/or maintain in effect the insurances referred to in GCC 34.5, the Implementing Partner may take out and maintain in effect any such insurances and may from time to time deduct from any amount due the EESL under the Contract any premium that the Implementing Partner shall have paid to the insurer, or may otherwise recover such amount as a debt due from the EESL. If the Implementing Partner fails to or is unable to take out and maintain in effect any such insurances, the Implementing Partner shall nevertheless have no liability or responsibility towards the EESL, and the Implementing Partner shall have full recourse against the EESL for any and all liabilities of the EESL herein.

34.7 Unless otherwise provided in the Contract, the Implementing Partner shall prepare and conduct all and any claims made under the policies effected by it pursuant to this GCC Clause 34, and all monies payable by any insurers shall be paid to the Implementing Partner as per the procedure outlined in GCC Sub- Clause 34.8 below. The EESL shall give to the Implementing Partner all such reasonable assistance as may be required by the Implementing Partner. With respect to insurance claims in which the EESL's interest is involved, the Implementing Partner shall not give any release or make any compromise with the insurer without the prior written consent of the EESL. With respect to insurance claims in which the Implementing Partner's interest is involved, the EESL shall not give any release or make any compromise with the insurer without the prior written consent of the Implementing Partner.

34.8 (i) wherever total damages/loss of equipment/material, would occur, the Implementing Partner will be entitled to payment of all payments received from the underwriters except the following amounts:

(a) The amount paid to the Implementing Partner under the Contract in respect of equipment/material damaged/lost (excluding the pro-rata initial advance) but including the entire amount of escalation, if any, already paid to the Con-tractor.

(b) Custom Duties and other taxes and duties which have already been paid by the EESL.

In the event the claim money settled, is less than the total of the amount in a & b above, then the entire claim money settled will be retained by the EESL and the Implementing Partner will forth-with pay the EESL the short fall amount between the claim money and the total of amounts as per a & b mentioned above.

Subsequent payments, if any, due under the Contract shall be regulated by the relevant terms of payment.

(II) In case of damage to any equipment/material during any stage, the Implementing Partner upon rectification of the damaged equipment to the satisfaction of the EESL shall be paid to the extent of full claims settled by the underwriters.



Signature :-
Subject : CN=DEEPAK MITTAL, ST=DELHI, OID.2.5.4.17=110003, OU=CONTRACTS AND
PROCUREMENT, O=ENERGY EFFICIENCY SERVICES LIMITED, C=IN
User ID : deepak.mittal
Serial No : F3FA77

35 Unforeseen Conditions

35.1 If, during the execution of the Contract, the Implementing Partner shall encounter on the Site any physical conditions (other than climatic conditions) or artificial obstructions that could not have been reasonably foreseen prior to the date of the Contract Agreement by an experienced Implementing Partner on the basis of reasonable examination of the data relating to the Facilities (including any data as to boring tests) provided by the EESL, and on the basis of information that it could have obtained from a visual inspection of the Site (if access thereto was available) or other data readily available to it relating to the Facilities, and if the Implementing Partner determines that it will in consequence of such conditions or obstructions incur additional cost and expense or require additional time to perform its obligations under the Contract that would not have been required if such physical conditions or artificial obstructions had not been encountered, the Implementing Partner shall promptly, and before performing additional work or using additional Plant and Equipment or Implementing Partner's Equipment, notify the Project Manager in writing of

- a) the physical conditions or artificial obstructions on the Site that could not have been reasonably foreseen.
- b) the additional work and/or Plant and Equipment and/or Implementing Partner's Equipment required, including the steps which the Implementing Partner will or proposes to take to overcome such conditions or obstructions.
- c) the extent of the anticipated delay.
- d) the additional cost and expense that the Implementing Partner is likely to incur.

On receiving any notice from the Implementing Partner under this GCC Sub-Clause 35.1, the Project Manager shall promptly consult with the EESL and Implementing Partner and decide upon the actions to be taken to overcome the physical conditions or artificial obstructions encountered. Following such consultations, the Project Manager shall instruct the Implementing Partner, with a copy to the EESL, of the actions to be taken.

35.2 Any reasonable additional cost and expense incurred by the Implementing Partner in following the instructions from the Project Manager to overcome such physical conditions or artificial obstructions referred to in GCC Sub-Clause 35.1 shall be paid by the EESL to the Implementing Partner as an addition to the Contract Price.

35.3 If the Implementing Partner is delayed or impeded in the performance of the Contract because of any such physical conditions or artificial obstructions referred to in GCC Sub-Clause 35.1, the Time for Completion shall be extended in accordance with GCC Clause 40 (Extension of Time for Completion).

36 Change in Laws and Regulations

36.1 If, after the date seven (7) days prior to the date of Bid submission, in the country where the Site is located, any law, regulation, ordinance, order or by-law having the force of law is enacted, promulgated, abrogated or changed (which shall be deemed to include any change in interpretation or application by the competent authorities) that subsequently affects the costs and expenses of the Implementing Partner and/or the Time for Completion, the Contract Price shall be correspondingly increased or decreased, and/or the Time for Completion shall be reasonably adjusted to the extent that the Implementing Partner has thereby been affected in the performance of any of its obligations under the Contract. However, these adjustments would be restricted to direct transactions between the EESL and the Implementing Partner/Assignee of Foreign Implementing Partner (if applicable). These adjustments shall not be applicable on procurement of raw materials, intermediary components etc. by the Implementing Partner/Assignee of Foreign Implementing Partner and shall also not be applicable on bought out items despatched directly from sub-vendor works to site. Further, no adjustment of the Contract Price and/or payment or reimbursement of taxes, duties or levies shall be made on account of variation in or withdrawal of Deemed Export benefits. Notwithstanding the foregoing, such additional or reduced costs shall not be separately paid or credited if the same has already been accounted for in the price adjustment provisions where applicable, in accordance with the Appendix 2 to the Contract Agreement.

37 Force Majeure

37.1 "Force Majeure" shall mean any event beyond the reasonable control of the EESL or of the Implementing Partner, as the case may be, and which is unavoidable notwithstanding the reasonable care of the party affected.

37.2 If either party is prevented, hindered or delayed from or in performing any of its obligations under the Contract



by an event of Force Majeure, then it shall notify the other in writing of the occurrence of such event and the circumstances thereof within fourteen (14) days after the occurrence of such event.

37.3 The party who has given such notice shall be excused from the performance or punctual performance of its obligations under the Contract for so long as the relevant event of Force Majeure continues and to the extent that such party's performance is prevented, hindered or delayed. The Time for Completion shall be extended in accordance with GCC Clause 40 (Extension of Time for Completion).

37.4 The party or parties affected by the event of Force Majeure shall use reasonable efforts to mitigate the effect thereof upon its or their performance of the Contract and to fulfil its or their obligations under the Contract, but without prejudice to either party's right to terminate the Contract under GCC Sub-Clauses 37.6 and 38.5.

37.5 No delay or non performance by either party hereto caused by the occurrence of any event of Force Majeure shall

- a) constitute a default or breach of the Contract
- b) (subject to GCC Sub-Clauses 32.2, 38.3 and 38.4) give rise to any claim for damages or additional cost or expense occasioned thereby

If and to the extent that such delay or non performance is caused by the occurrence of an event of Force Majeure.

37.6 If the performance of the Contract is substantially prevented, hindered or delayed for a single period of more than sixty (60) days or an aggregate period of more than one hundred and twenty (120) days on account of one or more events of Force Majeure during the currency of the Contract, the parties will attempt to develop a mutually satisfactory solution, failing which the dispute shall be resolved in accordance with GCC Clause 6.

37.7 Notwithstanding GCC Sub-Clause 37.5, Force Majeure shall not apply to any obligation of the EESL to make payments to the Implementing Partner herein.

38 War Risks

38.1 "War Risks" shall mean any of the following events occurring or existing in or near the country (or countries) where the Site is located:

- a) war, hostilities or warlike operations (whether a state of war is declared or not), invasion, act of foreign enemy and civil war
- b) rebellion, revolution, insurrection, mutiny, usurpation of civil or military government, conspiracy, riot, civil commotion and terrorist acts, and
- c) any explosion or impact of any mine, bomb, shell, grenade or other projectile, missile, munitions or explosive of war.

38.2 Notwithstanding anything contained in the Contract, the Implementing Partner shall have no liability whatsoever for or with respect to

- a) destruction of or damage to Facilities, Plant & Equipment, or any part thereof
- b) destruction of or damage to property of the EESL or any third party
- c) injury or loss of life

if such destruction, damage, injury or loss of life is caused by any War Risks, and the EESL shall indemnify and hold the Implementing Partner harmless from and against any and all claims, liabilities, actions, lawsuits, damages, costs, charges or expenses arising in consequence of or in connection with the same.

38.3 If the Facilities or any Plant and Equipment or Implementing Partner's Equipment or any other property of the Implementing Partner used or intended to be used for the purposes of the Facilities shall sustain destruction or damage by reason of any War Risks, the EESL shall pay the Implementing Partner for

- a) any part of the Facilities or the Plant and Equipment so destroyed or damaged (to the extent not already



Signature :-
Subject : CN=DEEPAK MITTAL, ST=DELHI, OID.2.5.4.17=110003, OU=CONTRACTS AN
PROCUREMENT, O=ENERGY EFFICIENCY SERVICES LIMITED, C=IN
User ID : deepak.mittal
Serial No : F3FA77

paid for by the EESL)

- b) replacing or making good any Implementing Partner's Equipment or other property of the Implementing Partner so destroyed or damaged so far as may be required by the EESL, and as may be necessary for completion of the Facilities,
- c) replacing or making good any such destruction or damage to the Facilities or the Plant and Equipment or any part thereof.

If the EESL does not require the Implementing Partner to replace or make good any such destruction or damage to the Facilities, the EESL shall either request a change in accordance with GCC Clause 39 (Change in the Facilities), excluding the performance of that part of the Facilities thereby destroyed or damaged or, where the loss, destruction or damage affects a substantial part of the Facilities, shall terminate the Contract, pursuant to GCC Sub-Clause 42.1 (Termination for EESL's Convenience).

38.4 Notwithstanding anything contained in the Contract, the EESL shall pay the Implementing Partner for any increased costs or incidentals to the execution of the Contract that are in any way attributable to, consequent on, resulting from, or in any way connected with any War Risks, provided that the Implementing Partner shall as soon as practicable notify the EESL in writing of any such increased cost.

38.5 If during the performance of the Contract any War Risks shall occur that financially or otherwise materially affect the execution of the Contract by the Implementing Partner, the Implementing Partner shall use its reasonable efforts to execute the Contract with due and proper consideration given to the safety of its and its SubImplementing Partners' personnel engaged in the work on the Facilities, provided, however, that if the execution of the work on the Facilities becomes impossible or is substantially prevented for a single period of more than sixty (60) days or an aggregate period of more than one hundred and twenty (120) days on account of any War Risks, the parties will attempt to develop a mutually satisfactory solution, failing which the dispute will be resolved in accordance with GCC Clause 6.

38.6 In the event of termination pursuant to GCC Sub-Clauses 38.3, the rights and obligations of the EESL and the Implementing Partner shall be specified in GCC Sub-Clauses 42.1.2 and 42.1.3, except that the Implementing Partner shall have no entitlement to profit under paragraph (e) of GCC Sub-Clause 42.1.3 in respect of any unexecuted Facilities as of the date of termination.

H. Change in Contract Element

39.1 Changes in the Facilities

39.1.1 The EESL shall have the right to propose, and subsequently require, that the Project Manager order the Implementing Partner from time to time during the performance of the Contract to make any change, modification, addition or deletion to, in or from the Facilities (hereinafter called "Change"), provided that such Change falls within the general scope of the Facilities and does not constitute unrelated work and that it is technically practicable, taking into account both the state of advancement of the Facilities and the technical compatibility of the Change envisaged with the nature of the Facilities as specified in the Contract .

39.1.2 The Implementing Partner may from time to time during its performance of the Contract propose to the EESL (with a copy to the ProjectManager) any Change that the Implementing Partner considers necessary or desirable to improve the quality, efficiency or safety of the Facilities. The EESL may at its discretion approve or reject any Change proposed by the Implementing Partner.

39.1.3 Notwithstanding GCC Sub-Clauses 39.1.1 and 39.1.2, no change made necessary because of any default of the Implementing Partner in the performance of its obligations under the Contract shall be deemed to be a Change, and such change shall not result in any adjustment of the Contract Price or the Time for Completion.

39.1.4 The procedure on how to proceed with and execute Changes is specified in GCC Sub-Clauses 39.2 and 39.3.

39.2 Changes Originating from EESL

If the EESL proposes a Change pursuant to GCC Sub-Clause 39.1.1, it shall send to the Implementing Partner a "Request for Change Proposal," requiring the Implementing Partner to prepare and furnish to the Project Manager as soon as reasonably practicable a "Change Proposal," which shall include the following:

- a) brief description of the Change



Signature :-
Subject : CN=DEEPAK MITTAL, ST=DELHI, OID.2.5.4.17=110003, OU=CONTRACTS AND
PROCUREMENT, O=ENERGY EFFICIENCY SERVICES LIMITED, C=IN
User ID : deepak.mittal
Serial No : F3FA77

- b) effect on the Time for Completion
- c) estimated cost of the Change
- d) effect on Functional Guarantees (if any)
- e) effect on any other provisions of the Contract.

39.2.2 The pricing of any Change shall, as far as practicable, be calculated in accordance with the rates and prices included in the Contract. If the rates and prices of any change are in the Contract, the parties thereto shall agree on specific rates for the valuation of the Change.

39.2.3 If before or during the preparation of the Change Proposal it becomes apparent that the aggregate effect of compliance therewith and with all other Change Orders that have already become binding upon the Implementing Partner under this GCC Clause 39 would be to increase or decrease the Contract Price as originally set forth in Article 2 (Contract Price) of the Contract Agreement by more than fifteen (15) percent, the Implementing Partner may give a written notice of objection thereto prior to furnishing the Change Proposal as aforesaid. If the EESL accepts the Implementing Partner's objection, the EESL and the Implementing Partner shall agree on specific rates for valuation of the change.

39.2.4 Upon receipt of the Change Proposal, the EESL and the Implementing Partner shall mutually agree upon all matters therein contained including agreement on rates if such rates are not available in the Contract or if the limit of 15% set forth in Clause 39.2.3 has been exceeded. Within fourteen (14) days after such agreement, the EESL shall, if it intends to proceed with the Change, issue the Implementing Partner with a Change Order.

If the EESL is unable to reach a decision within fourteen (14) days, it shall notify the Implementing Partner with details of when the Implementing Partner can expect a decision.

If the EESL decides not to proceed with the Change for whatever reason, it shall, within the said period of fourteen (14) days, notify the Implementing Partner accordingly.

39.2.5 If the EESL and the Implementing Partner cannot reach agreement on the price for the Change, an equitable adjustment to the Time for Completion, or any other matters identified in the Change Proposal, the EESL may nevertheless instruct the Implementing Partner to proceed with the Change by issue of a "Pending Agreement Change Order."

Upon receipt of a Pending Agreement Change Order, the Implementing Partner shall immediately proceed with effecting the Changes covered by such Order. The parties shall thereafter attempt to reach agreement on the outstanding issues under the Change Proposal.

39.3 Changes Originating from Implementing Partner

39.3.1 If the Implementing Partner proposes a Change pursuant to GCC Sub-Clause 39.1.2, the Implementing Partner shall submit to the Project Manager a written "Application for Change Proposal," giving reasons for the proposed Change and including the information specified in GCC Sub-Clause 39.2.1.

Upon receipt of the Application for Change Proposal, the parties shall follow the procedures outlined in GCC Sub-Clauses 39.2.4 and 39.2.5

40. Extension of Time for Completion

40.1 The Time(s) for Completion specified in the SCC shall be extended if the Implementing Partner is delayed or impeded in the performance of any of its obligations under the Contract by reason of any of the following:

- a) any Change in the Facilities as provided in GCC Clause 39 (Change in the Facilities)
- b) any occurrence of Force Majeure as provided in GCC Clause 37 (Force Majeure), unforeseen conditions as provided in GCC Clause 35 (Unforeseen Conditions), or other occurrence of any of the matters specified or referred to in paragraphs (a), (b) and (c) of GCC Sub-Clause 32.2
- c) any suspension order given by the EESL under GCC Clause 41 (Suspension) hereof or reduction in the rate of progress pursuant to GCC Sub-Clause 41.2 or
- d) any changes in laws and regulations as provided in GCC Clause 36 (Change in Laws and Regulations) or
- e) any default or breach of the Contract by the EESL, specifically including failure to supply the items listed in



Appendix 6 (Scope of Works and Supply by the EESL) to the Contract Agreement, or any activity, act or omission of any other Implementing Partners employed by the EESL or

- f) any other matter specifically mentioned in the Contract;

by such period as shall be fair and reasonable in all the circumstances and as shall fairly reflect the delay or impediment sustained by the Implementing Partner.

40.2 Except where otherwise specifically provided in the Contract, the Implementing Partner shall submit to the Project Manager a notice of a claim for an extension of the Time for Completion, together with particulars of the event or circumstance justifying such extension as soon as reasonably practicable after the commencement of such event or circumstance. As soon as reasonably practicable after receipt of such notice and supporting particulars of the claim, the EESL and the Implementing Partner shall agree upon the period of such extension. In the event that the Implementing Partner does not accept the EESL's estimate of a fair and reasonable time extension, the Implementing Partner shall be entitled to refer the matter to the Adjudicator, pursuant to GCC Sub-Clause 6.1 (Adjudicator).

40.3 The Implementing Partner shall at all times use its reasonable efforts to minimize any delay in the performance of its obligations under the Contract.

41 Suspension

41.1 The EESL/ Project Manager may, by notice to the Implementing Partner, order the Implementing Partner to suspend performance of any or all of its obligations under the Contract. Such notice shall specify the obligation of which performance is to be suspended, the effective date of the suspension and the reasons therefore. The Implementing Partner shall thereupon suspend performance of such obligation (except those obligations necessary for the care or preservation of the Facilities) until ordered in writing to resume such performance by the Project Manager/ EESL.

If, by virtue of a suspension order given by the Project Manager/EESL other than by reason of the Implementing Partner's default or breach of the Contract, the Implementing Partner's performance of any of its obligations is suspended for an aggregate period of more than ninety (90) days, then at any time thereafter and provided that at that time such performance is still suspended, the Implementing Partner may give a notice to the Project Manager requiring that the EESL shall, within twenty-eight (28) days of receipt of the notice, order the resumption of such performance or request and subsequently order a change in accordance with GCC Clause 39 (Change in the Facilities), excluding the performance of the suspended obligations from the Contract.

If the EESL fails to do so within such period, the Implementing Partner may, by a further notice to the Project Manager, elect to treat the suspension, where it affects a part only of the Facilities, as a deletion of such part in accordance with GCC Clause 39 (Change in the Facilities) or, where it affects the whole of the Facilities, as termination of the Contract under GCC Sub-Clause 42.1 (Termination for EESL's Convenience).

41.2 If

- a) the EESL has failed to pay the Implementing Partner any sum due under the Contract within the specified period, has failed to approve any invoice or supporting documents without just cause pursuant to Appendix 1 (Terms and Procedures of Payment) to the Contract Agreement, or commits a substantial breach of the Contract, the Implementing Partner may give a notice to the EESL that requires payment of such sum, requires approval of such invoice or supporting documents, or specifies the breach and requires the EESL to remedy the same, as the case may be. If the EESL fails to pay such sum, fails to approve such invoice or supporting documents or give its reasons for withholding such approval, or fails to remedy the breach or take steps to remedy the breach within fourteen (14) days after receipt of the Implementing Partner's notice or
- b) the Implementing Partner is unable to carry out any of its obligations under the Contract for any reason attributable to the EESL, including but not limited to the EESL's failure to provide possession of or access to the Site or other areas in accordance with GCC Sub-Clause 10.2, or failure to obtain any governmental permit necessary for the execution and/or completion of the Facilities; then the Implementing Partner may by fourteen (14) days' notice to the EESL suspend performance of all or any of its obligations under the Contract, or reduce the rate of progress.

41.3 If the Implementing Partner's performance of its obligations is suspended or the rate of progress is reduced pursuant to this GCC Clause 41, then the Time for Completion shall be extended in accordance with GCC Sub-



Clause 40.1, and any and all additional costs or expenses incurred by the Implementing Partner as a result of such suspension or reduction shall be paid by the EESL to the Implementing Partner in addition to the Contract Price, except in the case of suspension order or reduction in the rate of progress by reason of the Implementing Partner's default or breach of the Contract.

41.4 During the period of suspension, the Implementing Partner shall not remove from the Site any Plant and Equipment, any part of the Facilities or any Implementing Partner's Equipment, without the prior written consent of the EESL.

42 Termination

42.1 Termination for EESL's Convenience

42.1.1 The EESL may at any time terminate the Contract for any reason by giving the Implementing Partner a notice of termination that refers to this GCC Sub-Clause 42.1.

42.1.2 Upon receipt of the notice of termination under GCC Sub-Clause 42.1.1, the Implementing Partner shall either immediately or upon the date specified in the notice of termination

- (a) cease all further work, except for such work as the EESL may specify in the notice of termination for the sole purpose of protecting that part of the Facilities already executed, or any work required to leave the Site in a clean and safe condition
- (b) terminate all subcontracts, except those to be assigned to the EESL pursuant to paragraph (d)(ii) below
- (c) remove all Implementing Partner's Equipment from the Site, repatriate the Implementing Partner's and its SubImplementing Partners' personnel from the Site, remove from the Site any wreckage, rubbish and debris of any kind, and leave the whole of the Site in a clean and safe condition.
- (d) In addition, the Implementing Partner, subject to the payment specified in GCC Sub-Clause 42.1.3, shall
 - (i) Deliver to the EESL the parts of the Facilities executed by the Implementing Partner up to the date of termination
 - (ii) to the extent legally possible, assign to the EESL all right, title and benefit of the Implementing Partner to the Facilities and to the Plant and Equipment as at the date of termination, and, as may be required by the EESL, in any subcontracts concluded between the Implementing Partner and its SubImplementing Partners
 - (iii) deliver to the EESL all non-proprietary drawings, specifications and other documents prepared by the Implementing Partner or its SubImplementing Partners as at the date of termination in connection with the Facilities.

42.1.3 In the event of termination of the Contract under GCC Sub-Clause 42.1.1, the EESL shall pay to the Implementing Partner the following amounts:

- (a) the Contract Price, properly attributable to the parts of the Facilities executed by the Implementing Partner as of the date of termination
- (b) the costs reasonably incurred by the Implementing Partner in the removal of the Implementing Partner's Equipment from the Site and in the repatriation of the Implementing Partner's and its SubImplementing Partners' personnel.
- (c) any amounts to be paid by the Implementing Partner to its SubImplementing Partners in connection with the termination of any subcontracts, including any cancellation charges.
- (d) costs incurred by the Implementing Partner in protecting the Facilities and leaving the Site in a clean and safe condition pursuant to paragraph (a) of GCC Sub-Clause 42.1.2



- (e) the cost of satisfying all other obligations, commitments and claims that the Implementing Partner may in good faith have undertaken with third parties in connection with the Contract and that are not covered by paragraphs (a) through (d) above.

42.2 Termination for Contractor or Implementing Partner's Default

42.2.1 The EESL, without prejudice to any other rights or remedies it may possess, may terminate the Contract forthwith in the following circumstances by giving a notice of termination and its reasons therefor to the Implementing Partner, referring to this GCC Sub-Clause 42.2:

- (a) if the Implementing Partner becomes bankrupt or insolvent, has a receiving order issued against it, compounds with its creditors, or, if the Implementing Partner is a corporation, a resolution is passed or order is made for its winding up (other than a voluntary liquidation for the purposes of amalgamation or reconstruction), a receiver is appointed over any part of its undertaking or assets, or if the Implementing Partner takes or suffers any other analogous action in consequence of debt.
- (b) if the Implementing Partner assigns or transfers the Contract or any right or interest therein in violation of the provision of GCC Clause 43 (Assignment).
- (c) if the Implementing Partner, in the judgement of the EESL has engaged in corrupt or fraudulent practices in competing for or in executing the Contract.

For the purpose of this Sub-Clause:

"corrupt practice" means the offering, giving, receiving or soliciting of any thing of value to influence the action of a public official in the procurement process or in contract execution.

"fraudulent practice" means a misrepresentation of facts in order to influence a procurement process or the execution of a contract to the detriment of the EESL and includes collusive practice among Bidders (prior to or after bid submission) designed to establish bid prices at artificial non-competitive levels and to deprive the EESL of the benefits of free and open competition.

42.2.2 If the Implementing Partner

- (a) has abandoned or repudiated the Contract
- (b) has without valid reason failed to commence work on the Facilities promptly or has suspended (other than pursuant to GCC Sub-Clause 41.2) the progress of Contract performance for more than twenty-eight (28) days after receiving a written instruction from the EESL to proceed
- (c) persistently fails to execute the Contract in accordance with the Contract or persistently neglects to carry out its obligations under the Contract without just cause
- (d) refuses or is unable to provide sufficient materials, services or labor to execute and complete the Facilities in the manner specified in the program furnished under GCC Clause 18 (Program of Performance) at rates of progress that give reasonable assurance to the EESL that the Implementing Partner can attain Completion of the Facilities by the Time for Completion as extended

then the EESL may, without prejudice to any other rights it may possess under the Contract, give a notice to the Implementing Partner stating the nature of the default and requiring the Implementing Partner to remedy the same. If the Implementing Partner fails to remedy or to take steps to remedy the same within fourteen (14) days of its receipt of such notice, then the EESL may terminate the Contract forthwith by giving a notice of termination to the Implementing Partner that refers to this GCC Sub-Clause 42.2.

42.2.3 Upon receipt of the notice of termination under GCC Sub-Clauses 42.2.1 or 42.2.2, the Implementing Partner shall, either immediately or upon such date as is specified in the notice of termination,



cease all further work, except for such work as the EESL may specify in the notice of termination for the sole purpose of protecting that part of the Facilities already executed, or any work required to leave the Site in a clean and safe condition

- (a) terminate all subcontracts, except those to be assigned to the EESL pursuant to paragraph (d) below
- (b) deliver to the EESL the parts of the Facilities executed by the Implementing Partner up to the date of termination.
- (c) to the extent legally possible, assign to the EESL all right, title and benefit of the Implementing Partner to the Works. and to the Plant and Equipment as at the date of termination, and, as may be required by the EESL, in any subcontracts concluded between the Implementing Partner and its SubImplementing Partners.
- (d) deliver to the EESL all drawings, specifications and other documents prepared by the Implementing Partner or its SubImplementing Partners as at the date of termination in connection with the Facilities.

42.2.4 The EESL may enter upon the Site, expel the Implementing Partner, and complete the Facilities itself or by employing any third party. The EESL may, to the exclusion of any right of the Implementing Partner over the same, take over and use with the payment of a fair rental rate to the Implementing Partner, with all the maintenance costs to the account of the EESL and with an indemnification by the EESL for all liability including damage or injury to persons arising out of the EESL's use of such equipment, any Implementing Partner's Equipment owned by the Implementing Partner and on the Site in connection with the Facilities for such reasonable period as the EESL considers expedient for the supply and installation of the Facilities.

Upon completion of the Facilities or at such earlier date as the EESL thinks appropriate, the EESL shall give notice to the Implementing Partner that such Implementing Partner's Equipment will be returned to the Implementing Partner at or near the Site and shall return such Implementing Partner's Equipment to the Implementing Partner in accordance with such notice. The Implementing Partner shall thereafter without delay and at its cost remove or arrange removal of the same from the Site.

42.2.5 Subject to GCC Sub-Clause 42.2.6, the Implementing Partner shall be entitled to be paid the Contract Price attributable to the Facilities executed as at the date of termination, the value of any unused or partially used Plant and Equipment on the Site, and the costs, if any, incurred in protecting the Facilities and in leaving the Site in a clean and safe condition pursuant to paragraph (a) of GCC Sub-Clause 42.2.3. Any sums due to the EESL from the Implementing Partner accruing prior to the date of termination shall be deducted from the amount to be paid to the Implementing Partner under this Contract.

42.2.6 If the EESL completes the Facilities, the cost of completing the Facilities by the EESL shall be determined.

If the sum that the Implementing Partner is entitled to be paid, pursuant to GCC Sub-Clause 42.2.5, plus the reasonable costs incurred by the EESL in completing the Facilities, exceeds the Contract Price, the Implementing Partner shall be liable for such excess.

If such excess is greater than the sums due to the Implementing Partner under GCC Sub-Clause 42.2.5, the Implementing Partner shall pay the balance to the EESL, and if such excess is less than the sums due to the Implementing Partner under GCC Sub-Clause 42.2.5, the EESL shall pay the balance to the Implementing Partner.

The EESL and the Implementing Partner shall agree, in writing, on the computation described above and the manner in which any sums shall be paid.

42.3 Termination by Contractor or Implementing Partner

42.3.1 If

(a) the EESL has failed to pay the Implementing Partner any sum due under the Contract within the specified period, has failed to approve any invoice or supporting documents without just cause pursuant to Appendix 1 (Terms and Procedures of Payment) of the Contract Agreement, or commits a substantial breach of the Contract, the Implementing Partner may give a notice to the EESL that requires payment of such sum, requires approval of



Signature :-
Subject : CN=DEEPAK MITTAL, ST=DELHI, OID.2.5.4.17=110003, OU=CONTRACTS AN
PROCUREMENT, O=ENERGY EFFICIENCY SERVICES LIMITED, C=IN
User ID : deepak.mittal
Serial No : F3FA77

such invoice or supporting documents, or specifies the breach and requires the EESL to remedy the same, as the case may be. If the EESL fails to pay such sum, fails to approve such invoice or supporting documents or give its reasons for withholding such approval, fails to remedy the breach or take steps to remedy the breach within fourteen (14) days after receipt of the Implementing Partner's notice, or

(b) the Implementing Partner is unable to carry out any of its obligations under the Contract for any reason attributable to the EESL, including but not limited to the EESL's failure to provide possession of or access to the Site or other areas or failure to obtain any governmental permit necessary for the execution and/or completion of the Facilities which the EESL is required to obtain as per provision of the Contract or as per relevant applicable laws of the country,

then the Implementing Partner may give a notice to the EESL thereof, and if the EESL has failed to pay the outstanding sum, to approve the invoice or supporting documents, to give its reasons for withholding such approval, or to remedy the breach within twenty-eight (28) days of such notice, or if the Implementing Partner is still unable to carry out any of its obligations under the Contract for any reason attributable to the EESL within twenty-eight (28) days of the said notice, the Implementing Partner may by a further notice to the EESL referring to this GCC Sub-Clause 42.3.1, forthwith terminate the Contract.

42.3.2 The Implementing Partner may terminate the Contract forthwith by giving a notice to the EESL to that effect, referring to this GCC Sub-Clause 42.3.2, if the EESL becomes bankrupt or insolvent, has a receiving order issued against it, compounds with its creditors, or, being a corporation, if a resolution is passed or order is made for its winding up (other than a voluntary liquidation for the purposes of amalgamation or reconstruction), a receiver is appointed over any part of its undertaking or assets, or if the EESL takes or suffers any other analogous action in consequence of debt.

42.3.3 If the Contract is terminated under GCC Sub-Clauses 42.3.1 or 42.3.2, then the Implementing Partner shall immediately

(a) cease all further work, except for such work as may be necessary for the purpose of protecting that part of the Facilities already executed, or any work required to leave the Site in a clean and safe condition

(b) terminate all subcontracts, except those to be assigned to the EESL pursuant to paragraph (d)(ii)

(c) remove all Implementing Partner's Equipment from the Site and repatriate the Implementing Partner's and its SubImplementing Partner's personnel from the Site

(d) In addition, the Implementing Partner, subject to the payment specified in GCC Sub-Clause 42.3.4, shall

(i) deliver to the EESL the parts of the Facilities executed by the Implementing Partner up to the date of termination

(ii) to the extent legally possible, assign to the EESL all right, title and benefit of the Implementing Partner to the Facilities and to the Plant and Equipment as of the date of termination, and, as may be required by the EESL, in any subcontracts concluded between the Implementing Partner and its SubImplementing Partners

(iii) deliver to the EESL all drawings, specifications and other documents prepared by the Implementing Partner or its SubImplementing Partners as of the date of termination in connection with the Facilities.

42.3.4 If the Contract is terminated under GCC Sub-Clauses 42.3.1 or 42.3.2, the EESL shall pay to the Implementing Partner all payments specified in GCC Sub-Clause 42.1.3, and reasonable compensation for all loss or damage sustained by the Implementing Partner arising out of, in connection with or in consequence of such termination.

42.3.5 Termination by the Implementing Partner pursuant to this GCC Sub-Clause 42.3 is without prejudice to any other rights or remedies of the Implementing Partner that may be exercised in lieu of or in addition to rights conferred by GCC Sub-Clause 42.3.

42.4 In this GCC Clause 42, the expression "Facilities executed" shall include all work executed, Installation Services provided, any or all Plant and Equipment acquired (or subject to a legally binding obligation to purchase by



the Implementing Partner and used or intended to be used for the purpose of the Facilities, up to and including the date of termination.

42.5 In this GCC Clause 42, in calculating any monies due from the EESL to the Implementing Partner, account shall be taken of any sum previously paid by the EESL to the Implementing Partner under the Contract, including any advance payment paid pursuant to Appendix 1 (Terms and Procedures of Payment) to the Contract Agreement.

43. Assignment

43.1 The Implementing Partner shall not, without the express prior written consent of the EESL, assign to any third party the Contract or any part thereof, or any right, benefit, obligation or interest therein or thereunder, except that the Implementing Partner shall be entitled to assign either absolutely or by way of charge any monies due and payable to it or that may become due and payable to it under the Contract.

44. Bankruptcy

If the Contractor shall become bankrupt or have a receiving order made against him or compound with his creditors, or being a corporation commence to be wound up, not being a voluntary winding up for the purpose only of amalgamation / reconstruction, or carry on its business under a receiver for the benefit of its creditors or any of them, the Owner will be at liberty :

to terminate the contract forthwith by notice in writing to the liquidator or receiver or to any person in whom the contract may become vested & to act in the manner provided in GCC clause 42 entitled "Termination" as though the last mentioned notice has been the notice referred to in such clause and the equipment and materials have been taken out of the contractor's hands.

to give such liquidator, receiver or other person, the option of carrying out the contract subject to his providing a guarantee, for the due and faithful performance of the contract up to an amount to be determined by the Owner.

45. Contractor Performance & Feedback and Evaluation System

The Employer has in place an established 'Contractor Performance & Feedback System' against which the contractor's performance during the execution of contract shall be evaluated on a continuous basis at regular intervals. In case the performance of the contractor is found unsatisfactory on any of the following four parameters, the contractor shall be considered ineligible for participating in future tenders for a period as may be decided by the Employer.

Financial Status

Project Execution & Project Management Capability

Engineering & QA Capability

Claims & Disputes.

46. Fraud Prevention Policy

The contractor along with their associate/collaborator/sub-contractors/sub-vendors/ consultants/service providers shall strictly adhere to the Fraud Prevention Policy of EESL displayed on its tender website www.eeslindia.org

The Contractor along with their associate/collaborator/sub-contractors/sub-vendors/ consultants/service providers shall observe the highest standard of ethics and shall not indulge or allow anybody else working in their organisation to indulge in fraudulent activities during execution of the contract. The contractor shall immediately apprise the Employer about any fraud or suspected fraud as soon as it comes to their notice.



Signature :-
Subject : CN=DEEPAK MITTAL, ST=DELHI, OID.2.5.4.17=110003, OU=CONTRACTS AN
PROCUREMENT, O=ENERGY EFFICIENCY SERVICES LIMITED, C=IN
User ID : deepak.mittal
Serial No : F3FA77

SECTION-4 TECHNICAL & SPECIAL CONDITIONS OF CONTRACT

NOTE: THE TERMS & CONDITIONS STIPULATED HEREIN (I.E., IN SECTION-4) WILL SUPERSEDE ANY CONTRADICTORY/SIMILAR/OVERLAPPING TERMS & CONDITIONS IN ANY OTHER SECTION/PART OF THE TENDER.

NOTE:

Bidders are requested to select the **NON PARTICIPATING CLUSTERS** and click on **DELETE** option and then **PROCEED**. Bidders has to mandatorily declare the participating **CLUSTERS** against this tender as per Attachment No.12 attached in Section-6 of tender documents. Only price-bid of the declared Lots in Attachment No.12 shall be opened subject to acceptance of technical bid.

Name of Work: - Design, Manufacture, Supply, Transport, Installation, Testing and Commissioning of approximate 1,75,000 numbers of Off Grid Solar Photovoltaic Water Pumping Systems in selected States on PAN India basis, including complete system warranty and its repair and maintenance for 5 Years under MNRE off-grid and decentralized solar PV applications scheme on behalf of State Nodal Agencies (SNAs).

NIT/Bid Document No.: - EESL/06/2019-20/KUSUM/SWPS /Phase-1/Off Grid//192007012

Dated:- 21.08.2019

BIDS ARE TO BE SUBMITTED AS FOLLOWS: -

Envelope 1, 2 and 3 will appear online in dynamic form. No Manual/Hard Copy of documents need to be submitted for these envelopes apart from below mentioned documents.

Envelope 1 (Pre-Qualifying documents) should contain following:

- a. Bid document fee in the form of Banker's Cheque/ Demand Draft drawn in favor of "Energy Efficiency Services Limited" payable at New Delhi. **(To be submitted in hard copy/ manually in the tender-box on and before Technical E-Bid Opening Date & Time. Scanned Copy to be uploaded at E-tendering portal.)**
- b. Bid Security Fee/Earnest Money Deposit as **Attachment-2** by Banker's Cheque / Demand Draft drawn in favor of "Energy Efficiency Services Limited" or in the form of Bank Guarantee as per prescribed format in section 6. **(To be submitted in hard copy/ manually in the tender-box on and before Technical E-Bid Opening Date & Time. Scanned Copy to be uploaded at E-tendering portal)**
- c. Letter of the bidder submitting the bid in the form as stipulated in the bid document i.e., as per Bid Form as **Attachment-1** of section - 6, Forms & Procedures. **(Scanned Copy to be uploaded at E-tendering portal)** Duly filled and Signed by authorized signatory.
- d. Power of attorney to sign the bid as **Attachment-3** of section 6, Forms & Procedure. Bidders to use their own format. **(Scanned Copy to be uploaded at E-tendering portal).**
- e. Certificate regarding acceptance of important terms and conditions as per ITB clause 4.6 as **Attachment-4**. Format enclosed in section 6. **(Scanned Copy to be uploaded at E-tendering portal)** Duly filled and Signed by authorized signatory.
- f. Form of acceptance of EESL fraud prevention policy and declaration as per **Attachment- 7** of section 6, Forms & Procedure. **(Scanned Copy to be uploaded at E-tendering portal)** Duly filled and Signed by authorized signatory.
- g. NEFT/RTGS Bank details as per **Attachment-10** of section-6, forms and procedure. **(Scanned Copy to be uploaded at E-tendering portal)** Duly filled and Signed by authorized signatory.

NIT/Bid Document No.: EESL/06/2019-20/KUSUM/SWPS/Phase-1/Off Grid/
192007012 Dated: 21-08-2019

SECTION -4
Technical &
SCC

Page 1 of 102



- h. Self-Declaration for not been blacklisted by Central/State/UT Government or any Public sector entities duly signed and stamped at company's Letter Head. **(Scanned Copy to be uploaded at E-tendering portal)**
- i. Declaration form for quantity quoted (as per format in attachment -11) duly filled and Signed on Company's Letter Head Pad with Company seal. **(Scanned Copy to be uploaded at E-tendering portal)**

Envelope-II, i.e., Techno-Commercial Proposal of the Bid Should Contain (scanned copies of) the following:

- i. Deviation statement as per attachment 5 of section - 6, Forms & Procedure.
NOTE: EESL reserves the right to consider or disregard deviations, and reject bids in case of non-compliance. Bids containing material deviations from or reservation to the terms and conditions and specifications mentioned in the Tender will be treated as non-responsive and will not be considered further.
- ii. Compliance to Technical Specification Defined at **ANNEXURE-II** with supporting Documents.
- iii. Techno-commercial bid as indicated in bid document, i.e., **documentary evidences regarding bidder's qualifications to perform the Contract, as required per the Qualifying Requirements (Attached at Annexure-III)**.
- iv. Specific Confirmation from the Bidder to be Filled and attached as provided in **ANNEXURE –V**.
- v. One complete set of RFP documents and subsequent amendments (if any), duly signed and stamped on each page.
- vi. **Duly Filled Format 1, 2 and 3 as attached in the last of this section.** Please note that in absence of these formats, bid may not be evaluated.
- vii. Format-6 to be mandatorily filled and submitted online.

Envelope-III should contain Price Bid (to be filled-up online)

Since the bids are to be submitted through E-tendering mode, the prices are to be filled on e-tender portal only and bidders are requested **not to submit the price bid in hard copy at EESL along with the documents. The same will not be entertained.**

1. Price Bid Sheet Format is prescribed at **ANNEXURE-V1** in the Tender document – only for illustration purpose (***prices are to be filled on E-tender portal only***).

- i. Price Bid in the format prescribed in the tender document for **CLUSTER 1**
- ii. Price Bid in the format prescribed in the tender document for **CLUSTER 2**
- iii. Price Bid in the format prescribed in the tender document for **CLUSTER 3**
- iv. Price Bid in the format prescribed in the tender document for **CLUSTER 4**
- v. Price Bid in the format prescribed in the tender document for **CLUSTER 5**
- vi. Price Bid in the format prescribed in the tender document for **CLUSTER 6**
- vii. Price Bid in the format prescribed in the tender document for **CLUSTER 7**
- viii. Price Bid in the format prescribed in the tender document for **CLUSTER 8**
- ix. Price Bid in the format prescribed in the tender document for **CLUSTER 9**
- x. Price Bid in the format prescribed in the tender document for **CLUSTER 10**

2. Cost for Guarantee for period of 6-10 years as per Attachment-13 in Section-6 Forms and procedure (**Bidder has to mandatory fill up separate form (provided in attachment-13) and upload it in the portal along with Price Bid (i.e Envelope-3)**)

NIT/Bid Document No.: EESL/06/2019-20/KUSUM/SWPS/Phase-1/Off Grid/
192007012 Dated:- 18-07-2019

SECTION –4
Technical &
SCC

Page 2 of 102

Signature :-
Subject : CN=DEEPAK MITTAL, ST=DELHI, OID.2.5.4.17=110003, OU=CONTRACTS AND
PROCUREMENT, O=ENERGY EFFICIENCY SERVICES LIMITED, C=IN
User ID : deepak.mittal
Serial No : F3FA77



Opening & Further Processing of the Bids

Initially, Envelope-1 containing documents as stated above will be opened electronically.

Envelope-2 will be opened electronically preferably on the same day of only those bidders who have submitted EMD and requisite documents in Envelope-1.

In Envelope-3, Price Bid shall be opened subject to acceptance of Techno-Commercial Bid under Envelope-2. Opening date will be intimated to all those bidders, who are found technically & commercially acceptable to EESL.

Price-Bid of the technically disqualified bidders will not be opened.

Note- *Unorganized/Un-labelled Bids are liable to be rejected. Bidder to enclose an index of pages with proper nomenclature for each document enclosed and inserted page no. on the documents to be submitted online at E-tendering portal*

Price-Bid of the technically disqualified bidders will not be opened.

1. INTRODUCTION

Energy Efficiency Services Limited (EESL) is a joint venture of four National Public Sector Undertakings – NTPC Limited, Power Finance Corporation Limited, Rural Electrification Corporation Limited and POWERGRID Corporation of India Limited, set up under Ministry of Power, Government of India. EESL is a Super Energy Service Company (ESCO). It acts as the resource center for capacity building for State Distribution Companies (DISCOMs), Energy Regulatory Commissions (ERCs), State Development Authorities (SDAs), upcoming ESCOs, financial institutions, etc.

Objectives

- As a part of Implementation of "Off-grid and Decentralized Solar PV Applications Programme" during financial years 2019-20 and 2020-21 towards meeting the targets of the Jawaharlal Nehru National Solar Mission (JNNSM) main thrust was given on important applications especially relevant to rural development.
- Under the above said program, MNRE is going to implement approximate 1.75 lakh Solar Photovoltaic Water Pumping Systems (SPWPS) through centralized procurement process on behalf of SNAs.

Process:

1. The procurement process will be done by EESL.
2. Letter of Award will be issued by respective SNAs.
3. After issuance of LoA, the empanelled firm will take list of prospective beneficiaries from SNA and get the consent from beneficiaries in their favors. After submission of beneficiaries consent, SNA will issue **Notice To Proceed** to the empanelled firm for the installation of Solar Photovoltaic Water Pumping Systems (SPWPS).
4. The empanelled firm shall co-ordinate with SNAs (Implementing Agency) for repair and maintenance of SPWPS for a period of five years from the date of award of LoA.

NIT/Bid Document No.: EESL/06/2019-20/KUSUM/SWPS/Phase-1/Off Grid/
192007012 Dated:- 18-07-2019

SECTION –4
Technical &
SCC

Page 3 of 102

Signature :-
Subject : CN=DEEPAK MITTAL, ST=DELHI, OID.2.5.4.17=110003, OU=CONTRACTS AN
PROCUREMENT, O=ENERGY EFFICIENCY SERVICES LIMITED, C=IN
User ID : deepak.mittal
Serial No : F3FA77



SCOPE OF WORK:

The Scope of Work of a bidder shall include to Design, Manufacture, Supply, Erection, Testing and Commissioning of approximate 1,75,000 nos. of Stand-alone **Off Grid Solar Photovoltaic Water Pumping Systems** of in selected states on PAN India basis including complete system warranty and its repair and maintenance for 5 Years under MNRE off- grid and decentralized solar PV applications scheme: as per MNRE specifications and applicable BIS standards on behalf of SNAs for implementation after aggregating the demand from the States/UTs.

The scope of work covers:

A. Supply and Manufacture:

1. The selected vendor shall be responsible for design, supply, installation and commissioning of SPWPS along with 5 years of repair and maintenance. To ensure timely maintenance of SPWPS, apart from training a local person and making available necessary spare parts & tools in each block, the vendor shall have one authorized service center in each operational district and a help line(s) in English/Hindi or Regional language of the state where such SPWPS are installed.
2. The successful bidder(s) should submit Data Sheet, General Technical Particular (GTP), Design & General Arrangement (GA) drawing of the system (As provided by SNA's) along with Bill of Quantity (BOQ) for SNA's approval before supply/PDI. Also, bidder has to take drawing approval for the complete system from SNA's within 15 days from the award of LOA (Not applicable if SNA's provided drawing).
3. Each pump should be marked with Toll Free No. of successful bidder operating in English/Hindi or Regional language of respective state and specific pump numbers and the Pump No. must have been captured by SNA's Web based Application (as per instruction of SNA) at the time of installation at site. During the time of PDI of each component, test report of equipment's, warranty certificates and calibration certificates should be provided by the bidder. Also, bidder should submit module structure wind withstand capacity certificate from certified Architecture Engineer for wind speed of 150 Km/hour. Successful bidder has to submit the PDI request within one week from the date of clearance (site allocation) given by SNA's.

C. Installation & Commissioning:

1. Installation and commissioning of approximate 1,75,000 nos. (approx.) solar photovoltaic water pumping system shall be done by the successful bidder (s) as per the details provided by respective SNA. The vendors shall co-ordinate with respective SNAs for repair and maintenance of SPWPS for 5 yrs.
2. Empanelled firm have to submit monthly consent of beneficiaries in their favors to SNA for which SNA's will give **Notice To Proceed** and for this, empanelled firm shall complete the installation and Commissioning of SPWPS within 90 days of issuance of NTP.

However, for, **clusters 9 and 10 as per Annexure VII**, empanelled firm shall complete the installation and Commissioning of SPWPS within 120 days of issuance of such NTP.

3. Bidder should conduct site survey and provide DPR (Daily Progress Report) as per the requirement of SNA's.

NIT/Bid Document No.: EESL/06/2019-20/KUSUM/SWPS/Phase-1/Off Grid/
192007012 Dated:- 18-07-2019

SECTION -4
Technical &
SCC

Page 4 of 102

Signature :
Subject : CN=DEEPAK MITTAL, ST=DELHI, OID.2.5.4.17=110003, OU=CONTRACTS AND
PROCUREMENT, O=ENERGY EFFICIENCY SERVICES LIMITED, C=IN
User ID : deepak.mittal
Serial No : F3FA77



4. Action plan should be submitting to SNA's including complete details of team, resources, service centers in each district within 30 days of acceptance of demand from SNA's.
5. Intimation to be given to SNA's before one week of Pre-Dispatch inspection call and should submit complete warranty and test certificates of each lot at the time of inspection.
6. Submission of installation reports as per the format given by SNA's on weekly basis.
7. Submission of completion reports of each district to SNA's within one week of 100 % completion of work as per allocation in each district.
8. Successful bidder should submit monthly and quarterly progress reports online to SNA's.
9. Bidder shall comply with all applicable regulatory and statutory norms. Bidder has to obtain approval/NOC (where ever required) from appropriate Govt. authority for implementing the project in each selected village.
10. Successful bidder should have finalized sub-bidders and purchase order (P.O.) on all materials such as Solar PV module, structures, Pump, Controller, etc. within 30 days from the date of notification of award of Contract and unpriced P. O. copies will be submitted to SNA's within 30days from date of issue of LOA. Successful bidder should commission minimum pumps/quarter as defined in Scope of Work Clause C.2. Bidder has to obtain handing over certificates/ installation completion letters/certificates from respective village panchayats/ Local Govt. Bodies in parallel with installation (as per prescribed format and requirement of respective district administration else prescribed format of SNA's may be adopted).
11. Each SPWPS is to be provided with a colored metallic sticker duly riveted displaying required details as provided by SNA's.
12. Successful bidder should submit the Certificate (as per prescribed format-to be provided by SNA) and photographs of each SPWPS installed which must show complete installation setup with beneficiary, Pump number etc.
13. Successful bidder has to ensure working of minimum 95% of total installed SPWPS at any point of time.

Technical Requirements and testing:

1. Systems installed under this Programme should meet technical specification and construction standards as specified by BIS and MNRE from time to time as given in Annexure-II. Non-compliance will be taken seriously to the extent of blacklisting of the vendor.
2. Only indigenously manufactured PV modules and Pumps should be used in the Programme. **'Made in India'** to be mentioned on solar panels and pumps.
3. Interpretation of the Guidelines: In case of any ambiguity in interpretation of any of the provisions of these guidelines, the decision of the Ministry shall be final.
4. Review of Guidelines: The Guidelines would be reviewed by an Internal Review Committee Chaired by Secretary in MNRE and modifications therein would be incorporated by the Ministry.
5. Systems installed under this Programme should also follow Office Memorandum F.No. 146/57/2018-P&C of Ministry of New & Renewable Energy, Government of India dated 11.12.2018

D. Operation & Maintenance (O&M), Training, Awareness and sensitization:

1. Successful bidder should keep necessary spare parts (min 5% of allotted quantity of each component of the complete system at the service center at each district and should ensure proper maintenance of SPWPS to 5 years from the date of installation of each SPWPS. Bidder should also ensure to provide local training to local persons regarding proper maintenance of the SPWPS. Bidder should submit bi-weekly maintenance report to SNA's as per prescribed format provided. Also should provide quarterly inspection report of the installation as per prescribed format provided by SNA's.

NIT/Bid Document No.: EESL/06/2019-20/KUSUM/SWPS/Phase-1/Off Grid/
192007012 Dated:- 18-07-2019

SECTION -4
Technical &
SCC

Page 5 of 102

Signature :-
Subject : CN=DEEPAK MITTAL, ST=DELHI, OID.2.5.4.17=110003, OU=CONTRACTS AND
PROCUREMENT, O=ENERGY EFFICIENCY SERVICES LIMITED, C=IN
User ID : deepak.mittal
Serial No : F3FA77



2. Any complaint registered/ service calls received should be attended at the earliest and the system should be repaired/ restored/ replaced within 3 days from the date of complaint received/informed to the bidder.
3. The installation data should be punched in the Web Application Platform to be developed by SNA's as per the terms and conditions provided by MNRE.
4. The Ministry officials or designated agency may inspect the ongoing installation or installed plants. In case the installed systems are not as per standards, non-functional on account of poor quality of installation, or non-compliance of maintenance, the Ministry reserves the right to blacklist the vendor.
5. Bidder has to submit an Operation, Instruction and Maintenance Manual, in English and the local language, should be provided with each solar photovoltaic water pumping system to the beneficiary. The following minimum details must be provided in the Manual:

- Basic principles of Photovoltaic.
- A small write-up (with a block diagram) on solar photovoltaic water pumping system - its components, PV module, electronics and expected performance.
- A simple single line diagram (SLD) depicting the electrical circuits and control mechanism
- Type, Model number, Voltage & capacity of the motor, used in the system.
- The make, model number, country of origin.
- Significance of indicators.
- Clear instructions on regular maintenance and trouble-shooting of the solar photovoltaic water pumping system
- Preventive maintenance schedule
- Detail information about warranty coverage
- DO's and DONT's.
- Name and address of the contact person for repair and maintenance, in case of non-functionality of the solar photovoltaic water pumping system.
- Description of frequent faults of PV module and pump and its remedy.
- Minimum 10 hard copies (to be printed in booklet form) kept at each service center. Also, to be provided to SNA as and when required.

6. The Operation & Maintenance (O&M) cost of the system is in-built in the system cost. The bidder shall provide repair and maintenance of the system for 5 years.
7. Successful bidder shall do the preventive maintenance including cleaning of solar panel at the interval of every 4 months from the date of last SPWPS at each district and should submit the report in prescribed format to SNA's.
8. If complaint is not rectified within 3 days from the date of complaint received/informed to the bidder, in that case after 3 days INR 100 per pump/day penalty will be imposed, for first 3 days and thereafter Rs. 500/ per pump/day shall be imposed till the SPWPS put back to satisfactory working condition. This amount shall be recovered from running bills or CPG of the bidder.
9. Successful bidder shall submit the detailed report and short 5-minute high definition video per district including local training, awareness and sensitization campaigns, Methodology for sustainable maintenance for further five years to the beneficiaries with relevant photographs.

E. Completion Time:

Successful bidder should ensure to complete the project as per Clause C.2 and instruction of SNA's.

- The implementation work on ground should start within 15 days from the date of Notice To

NIT/Bid Document No.: EESL/06/2019-20/KUSUM/SWPS/Phase-1/Off Grid/ 192007012 Dated:- 18-07-2019	SECTION -4 Technical & SCC	Page 6 of 102
--	----------------------------------	---------------

Signature :-
Subject : CN=DEEPAK MITTAL, ST=DELHI, OID.2.5.4.17=110003, OU=CONTRACTS AND
PROCUREMENT, O=ENERGY EFFICIENCY SERVICES LIMITED, C=IN
User ID : deepak.mittal
Serial No : F3FA77



Proceed from SNA's.

- ✓ Successful bidder shall submit the unpriced P. O. copies of Solar PV module, Pumps, wires / cables etc. to SNA within 30 days from the date of notification of award of Contract. (Not applicable in case bidders itself manufacturing all the items.) In case unpriced PO copies within 30 days not submitted, SNA's may, cancel the contract and award the same quantity to another bidder.
- ✓ In order to achieve the target, suitable number of teams (one team with minimum of three members) must be deployed by the bidder.
- ✓ Time Schedule includes the time required for mobilization as well as testing, rectifications if any, retesting and completion in all respects to the entire satisfaction of Engineer-in-charge designated by SNA's.

F. Evaluation Criteria and Selection of Bidders:

The Tender Consists of 10 Clusters.

Package-1 (with normal controller): Design, Manufacture, Supply, Transport, Installation, Testing and Commissioning of Solar Photovoltaic Water Pumping Systems with a Remote Monitoring Facility with repair and maintenance period of 5 Years as per Technical Specification in Annexure-II.

Part A: 1 HP DC

Part B: 2HP DC

Part C: 3HP DC

Part D: 5HP DC

Part E: 7.5 HP DC

Part F: 1 HP AC

Part G: 2HP AC

Part H: 3 HP AC

Part I: 5 HP AC

Part J: 7.5 AC

Bidder has to quote for each part.

Bidder has an option to choose out of the 10 clusters for the ones it wishes to quote for. Bidder has to mandatorily submit declaration for states it wishes to quote for (i.e. attachment-12 of price bid)

A separate attachment -13 has been given in Section-6 Forms and procedures for filling up of prices for repair & maintenance cost for the period of 6-10 years for the state. **Bidder has to mandatorily submit attachment -13.**

However, selection of bidder will be done on the technically acceptable lowest evaluated cost basis (Effective Price) cluster-wise only. Price bid should be unconditional, failing which the bid shall be summarily rejected. The price to be quoted as per the prescribed format of price bid. Price will remain firm till **One year** from the date of opening of price bid.

Effective Price:

Effective price shall be calculated as per following formula:

Part A * W1+ Part B * W2 + Part C * W3 + Part D * W4 + Part E * W5 + Part F * W6 +Part G * W7+ Part H * W8+ Part I * W9+ Part J * W10

W1, W2, W3, W4, W5, W6, W7, W8, W9, W10 are defined (cluster wise) in Annexure VII.

NIT/Bid Document No.: EESL/06/2019-20/KUSUM/SWPS/Phase-1/Off Grid/ 192007012 Dated:- 18-07-2019	SECTION -4 Technical & SCC	Page 7 of 102
--	----------------------------------	---------------

Signature :-
Subject : CN=DEEPAK MITTAL, ST=DELHI, OID.2.5.4.17=110003, OU=CONTRACTS AND
PROCUREMENT, O=ENERGY EFFICIENCY SERVICES LIMITED, C=IN
User ID : deepak.mittal
Serial No : F3FA77



- i. The offers/bids received against the Tender (cluster 1 to cluster 10) shall be first evaluated as per Qualifying Requirements. Price bids of only those bidder(s) shall be opened who qualify against these QR and techno-commercial requirements.
- ii. Bidders can select the NON-PARTICIPATING Cluster and click on DELETE option to remove the cluster. Bidder has to mandatorily declare the participating Clusters against this tender as per Attachment No.12 in Section-6 of tender documents. Only price-bid of the declared Clusters in Attachment No.12 shall be opened subject to acceptance of technical bid.
- iii. Price Bids shall be opened for all the clusters simultaneously.
- iv. SNA reserves the right to divert the awarded quantity of successful bidder to third party if the bidder does not perform within one month as per the schedule on the risk and cost of the bidder.
- v. SNA reserves the right for the variation of +/- 20% of awarded Quantity State wise.
- vi. In view of the large tender quantity all eligible bidders will be empanelled cluster-wise subject to their quoted price within a range of (L1+10% of L1) price and acceptance of L1 rates with all other terms and conditions as per tender. The five (5) bidders will be empanelled on the basis of lowest price quoted by the bidders.
- vii. In case the number of bidders within a range of (L1++10% of L1) price is less than five(5), a price bracket shall be extended to (L1+ of +15% of L1) so that enough numbers of bidders can be empanelled.
- viii. Further, in case an empanelled party is not able to supply quantity allocated to them as per scheduled timelines, SNA reserves the right to shift the part/full quantity to other empanelled bidder, who has matched the price.
- ix. Please note that in all cases Matching of Prices will be on total landed cost for complete scope of work.
- x. For MSEs and startups purchase preference clause shall be valid as per the government guidelines.

G. Liquidated damages

In case of any delay in the execution of the order or delay in maintenance beyond the stipulated time schedule decided including any extension permitted in writing, SNA's reserves the right to recover from the bidder a sum equivalent to 0.5 % of the value of the delayed SPWPS installation or on the unexecuted portion of the work for each week of the delay and part thereof subject to a maximum of 5 % of the total value of the contract.

Alternatively, SNA's reserves the right to purchase of the material and completion of the works including maintenance from elsewhere at the sole risk and cost of the successful bidder/ contractor and recover all such extra cost incurred by SNA in procuring the material from resources available including encashment of the bank guarantee or any other sources etc. Further, if any extra cost is incurred by SNA's due to delay in work completion by the party beyond the completion time as per PO/LOA, the same shall be recovered from the party's Invoice/BG etc.

Alternatively, SNA may cancel the order completely or partly without prejudice to his right under the alternatives mentioned above.

H. ADJUDICATOR:

Adjudicator under the contract shall be appointed by the Appointing Authority of SNA. If the bidder does not accept the Adjudicator proposed by SNA, it should so state in its bid form and make





a counter proposal of an adjudicator. If on the day the contract agreement is signed, the SNA and contractor have not agreed on the appointment of adjudicator, the adjudicator shall be appointed, at the request of either party, by the MNRE.

I. ARBITRATION:

Arbitration shall be carried out as per Arbitration Act 1996 and its subsequent amendment. The Contract shall be governed by and interpreted in accordance with the laws in force in India. The Courts of respective cluster where programme is to be implemented shall have exclusive jurisdiction in all matters arising under the contract.

NIT/Bid Document No.: EESL/06/2019-20/KUSUM/SWPS/Phase-1/Off Grid/
192007012 Dated:- 18-07-2019

SECTION -4
Technical &
SCC

Page 9 of 102

Signature :
Subject : CN=DEEPAK MITTAL, ST=DELHI, OID.2.5.4.17=110003, OU=CONTRACTS AND
PROCUREMENT, O=ENERGY EFFICIENCY SERVICES LIMITED, C=IN
User ID : deepak.mittal
Serial No : F3FA77



J. WARRANTY AND MAINTENANCE:

1. The complete Solar Photovoltaic Water Pumping System and display board / Name Plate (SNA's will provide the details) shall be warranted and maintained for 5 years from the date of installation.
2. The maintenance service provided shall ensure proper functioning of the system as a whole. All preventive/routine maintenance and breakdown/corrective maintenance required for ensuring maximum uptime shall have to be provided by the Contractor.
3. Successful bidder, on whom letter of award is placed, is to ensure all safety guidelines, rules and regulations, labour laws etc. Successful bidder indemnifies SNA for any accident, injury met by its labour, employee or any other person working for him. Any compensation sought by its labour, employee or any other person working for him shall be paid by successful bidder as per settlement solely. SNA/EESL has no role to play in this matter.
4. Successful bidder is to submit interchangeability certificate for its product supplied for replacement during warranty and maintenance period and even when it is purchased from open market. In case due to change in technology, the supplied product is not available during warranty/ maintenance period than the improved version of product can be used in warranty/ maintenance period with same or improved technical parameters or the combination thereof after written communication of Engineer in Charge of SNA's at same cost & terms and conditions. Successful Bidder, on whom letter of award has been placed, has also to confirm that the prices of improved version of product are not lesser than the original product or its parts in comparison.
5. Local representative of bidder should meet governing authorities of each block and should submit the minutes of meeting to SNA's on quarterly basis.

The Bidder shall be deemed to have examined the Bid document, to have obtained his own information in all matters whatsoever that might affect carrying out the Works in line with the Scope of Work specified in the document at the offered rates and to have satisfied himself to the sufficiency of his Bid. The bidder shall be deemed to know the scope, nature and magnitude of the work and requirement of materials, equipment, tools and labour involved, wage structures and as to what all works he has to complete in accordance with the Bid documents irrespective of any defects, omissions or errors that may be found in the Bid documents.

Further SNA reserve the right to place a repeat order in case of urgency for equal to or more than ordered quantity in the Letter of Award for similar work. In case of poor performance/poor quality of material SNA reserves the right to short close / terminate the contract and award the work to third party at risk and cost of bidder.

K. TRANSPORTATION, DEMURRAGE, WHARFAGE, ETC.:

Contractor is required under the Contract to transport the Goods to place of destination defined as Site.

Subsequent to an order being placed against bidder's quotation, received in response to this 'enquiry', if it is found that the materials supplied are not of the right quality or not in

NIT/Bid Document No.: EESL/06/2019-20/KUSUM/SWPS/Phase-1/Off Grid/ 192007012 Dated: 18-07-2019 <small>Signature: DEEPAK MITTAL, DELHI, OID.2.5.4.17=110003, OU=CONTRACTS AND PROCUREMENT, O=ENERGY EFFICIENCY SERVICES LIMITED, C=IN User ID : deepak.mittal Serial No : F3FA77</small>	SECTION -4 Technical & SCC	Page 10 of 102
---	----------------------------------	----------------



accordance with our specifications (required by us) or received in damaged or broken conditions, not satisfactory owing to any reason of which we shall be the sole judge, EESL/SNA shall be entitled to reject the materials, cancel the contract and buy our requirement from the open market / other sources and recover the loss, if any, from the supplier reserving to ourselves the right to forfeit the security deposit, furnished by the supplier against the contract. The supplier will make his own arrangements to remove the rejected material within a fortnight of instruction to do so. Thereafter material will lie entirely at the supplier's risk and responsibility and storage charges, along with any other charges applicable, will be recoverable from the supplier.

EESL/SNA reserve the right to accept or reject any quotation in full or in part without assigning any reason thereof. We also reserve the right to split and place order on more than one suppliers.

The bidder should not have been black-listed by any Central / State Government or Public Sector Undertakings. If at any stage of tendering process or during the currency of the contract, any suppression / falsification of such information is brought to the knowledge, SNA/EESL shall have the right to reject the proposal or terminate the contract, as the case may be, without any compensation to the bidder & forfeiture of bid security/EMD/CPG.

L. CONTRACT PERFORMANCE QUARANTEE (CPG):

Bidder shall submit a bank guarantee (BG) of 20% of the value of total state-wise allocation or 1000 nos. of SPWPS, whichever is lower, to respective SNA's with the validity of 1 year to be rolled over every year for the first five years. However, if total number of SPWPS is more than 20% of the value of total state-wise allocation or 1000 nos. in the first list of consent of beneficiaries in bidder's favor, bidder shall submit another CPG equivalent to differential value of order as per NTP.

Illustration:

For any state, Bidder has submitted the CPG equivalent to the order value of 1000 nos of SPWPS to SNA. After getting a list of beneficiaries, bidder submits consent of 1500 beneficiaries in his favor. In this case, bidder shall also submit a CPG equivalent to 500 (1500-1000) nos. of SPWPS to respective SNA to get NTP.

Incase, if consent of beneficiaries in bidder's favor is less than the value of submitted CPG, SNA shall return the original CPG within 15 days of receiving the new CPG equivalent to total awarded quantity to the bidder. However, such request for returning the CPG equivalent to unawarded capacity shall be considered only after 12 months of issuance of LoA.

Illustration:

For any state, Bidder has submitted the CPG equivalent to the order value of 1000 nos of SPWPS to SNA. However, in 12 months, bidder can only get 700 no.s of consent of beneficiaries in his favor. In this case, bidder can claim the return of CPG equivalent to the un-awarded capacity i.e, 300 (1000-700) after submitting the CPG equivalent to the awarded capacity i.e, 700 no.s of SPWPS.



ANNEXURE II**A. TECHNICAL SPECIFICATIONS OF SOLAR WATER PUMPING SYSTEM**

General Specifications of SPV Pumping Systems shall be in accordance with prevailing guidelines of MNRE; however the specifications of some components are also mentioned as follows –

1. SCOPE

These specification covers design qualifications and performance specifications for Centrifugal Solar Photo Voltaic (SPV) Water Pumping Systems to be installed on a suitable bore-well, open well, water reservoir, water stream, etc., and specifies the minimum standards to be followed under New Scheme for Farmers launched by Government of India on 8.3.2019.

2. TERMINOLOGY

In addition to the terminology specified in 3 of IS 5120 and IEC 62253, the following shall also apply.

2.1 Static Water Depth — It is the depth of water level below the ground level when the pump is not in operation.

2.2 Draw-Down — It is the elevation difference between the depth of static water level and the consistent standing water level in tube well during operation of pump set.

2.3 Submergence — It is the minimum height of water level after drawdown above the pump suction casing.

2.4 Manometric Suction Lift — Manometric suction lift is the vacuum gauge/suction manometer reading in meter of water column when pump operates at suction lift.

2.5 Static Suction Lift — Static suction lift/head is the vertical distance between sump water level and center of pump inlet.

2.6 Daily Water Output — It is the total water output on a clear sunny day with three times tracking SPV panel, under the “Average Daily Solar Radiation” condition of 7.15 KWh / m² on the surface of SPV array (i.e. coplanar with the SPV Modules).

2.7 Wire to Water Efficiency — It is the combined system efficiency of SPV Converter/Controller with Inbuilt MPPT mechanism, Pump set and piping.



2.8 Pump Controller— Pump Controller converts the DC voltage of the SPV array into a suitable DC or AC, single or multi-phase power and may also include equipment for MPPT, remote monitoring, and protection devices.

2.9 Maximum Power Point Tracker (MPPT) — MPPT is an algorithm that is included in the pump controller used for extracting maximum available power from SPV array under a given condition. The voltage at which SPV array can produce maximum power is called 'maximum power point' voltage (or peak power voltage).

3. CONSTRUCTIONAL FEATURES

3.1 General

3.1.1 SPV Water Pumping System set uses the irradiance available through SPV array. The SPV array produces DC power, which can be utilized to drive a DC or an AC pump set using pump controller.

3.2 A SPV Water Pumping system typically consists of:

3.2.1 Pump Set

Pump set may be of any one of the following types:

- i) Mono-set pump;
- ii) Open well submersible pump;
- iii) Submersible pump;

3.2.2 Motor

The motor of the pump set may be of the following types:

- i) AC Induction Motor.
- ii) DC Motor [PMSM/BLDC/SRM (with brush or brushless)].

3.2.3 SPV Controller See 2.8

Note: Some controllers are inbuilt in the motors

Controller:

Controller should be of the approved make and it should be in accordance with the electrical parameters of the Motor/Pump. Controllers should be fixed in suitable IP 54 Box with the provision of SPD as per norms of SNA. Controller must have Remote Monitoring Arrangement as per MNRE guidelines. Contractor shall have to provide a link for monitoring of installed SPV Pumps. Other detailed specifications of Controller are as per below table:



Specifications of Controller/Drive for Solar Water Pumping Systems

Sl. No.	Requirement	Specifications
1.	<i>Controller Power Capacity to drive the Pump</i>	Controller Power Capacity should match to Solar Panels Power Capacity, not Pump Capacity. Example: For 5HP Project, As per MNRE Specs, Panels should be minimum 4800W , Controller capacity also should be minimum 4800W only Operating frequency: 50Hz± 10% .
2.	<i>Point Tracking (MMPT)</i>	Should track power only and not Voltage at Maximum power point
3.	<i>Enclosure</i>	The Controller must have IP54 protection or must be housed in a cabinet having at least IP54 protection.
4.	<i>DC Circuit Breaker Disconnect Switch</i>	Should be between Solar panels and controller
5.	<i>GSM/GPRS</i>	Controller shall be integrated with GSM/GPRS gateway with Geo tagging. GSM/ GPRS Charges to be included in the Costing till the end of Warranty period of the Pump set
6.	<i>Protections</i>	<ul style="list-style-type: none"> x Dry Run x Open Circuit x Short Circuit x Reverse Polarity x Over Load x Over Temperature x Motor Jam Detection and Automatic Unjam with minimum 1.5 times of rated motor current for at least 30sec.
7.	<i>Display of Controller/Drive</i>	<p>Controller must have LCD Display. All Parameters and Faults/Protections should be clearly indicated on Display such as if controller shutdown with short circuit, it must clearly indicate on display as "Short Circuit" (No short cuts such as F1, F2 or any other indications). Below parameters must be appear on Display ON/OFF Status -</p> <ul style="list-style-type: none"> x Solar DC Voltage in Volts x Solar DC Current in Amps x DC Energy in Kwh x Output Currents in Amps (minimum 2-Phases) x Rotating Frequency in Hz x All Faults/Protection Status x Cumulative Total Water Output in litres x Pump On/Off Status
8.	<i>Data maintenance</i>	All parameters (as detailed above in item 7) from the Controller shall be pushed to Bidder's cloud/web server for every 15 minutes and the same to be maintained for the entire warranty Period. The access of this server shall be provided to respective SNA's on their request.



3.2.4 Provision for remote monitoring for the pumps must be made in the pump controller through an integral arrangement having following basic functions:

- Controller must be assigned with a unique serial number and its live status must be observed remotely on online portal through login credentials.
- Live status must indicate whether controller is ON/ OFF
- The parameter i.e. the water output, water flow rate, in fault condition, array input voltage/ current, power and motor frequency should at logged at an interval of 10 minutes
- Controller must have a back up to store the data locally (at least for 1 year)



3.3 Solar Photo Voltaic (SPV) Array

3.3.1 SPV arrays contains specified number of same capacity, type and specification modules connected in series or parallel to obtain the required voltage or current output. The SPV water pumping system should be operated with a PV array minimum capacity in the range of **900 Watts peak to 9000 Watts peak**, measured under Standard Test Conditions (STC). Sufficient number of modules in series and parallel could be used to obtain the required voltage or current output. The power output of individual PV modules used in the PV array, under STC, should be a minimum of **300 Watts peak**, with adequate provision for measurement tolerances. Use of PV modules with higher power output is preferred.

3.3.2 Modules supplied with the SPV water pumping systems shall have certificate as per IS14286/IEC 61215 specifications or equivalent National or International/ Standards. STC performance data supplied with the modules shall not be more than one year old.

3.3.3 Modules must qualify to IS/IEC 61730 Part I and II for safety qualification testing.

3.3.4 The minimum module efficiency should be minimum 15 percent and fill factor shall be more than 70 percent.

3.3.5 Modules must qualify to IEC TS 62804-1:2015 for the detection of potential-induced degradation - Part 1: Crystalline silicon (Mandatory in case the SPV array voltage is more than 600 V DC)

3.3.6 In case the SPV water pumping systems are intended for use in coastal areas the solar modules must qualify to IEC TS 61701:2011 for salt mist corrosion test.

3.3.7 The name plate shall conform the IS 14286/IEC 61215

3.3.8 Module to Module wattage mismatch in the SPV array mismatch shall be within ± 3 percent.

3.3.9 Variation in overall SPV array wattage from the specified wattages shall be within zero percent to +10 percent.

3.3.10 The PV Modules must be warranted for output wattage, which should not be less than 90% of the rated wattage at the end of 10 years and 80% of the rated wattage at the end of 25 years.

3.3.11 The RFID must be inside of module lamination. The module laminate, but must be able to withstand harsh environmental conditions.



3.4 Motor-Pump Set

3.4.1 The SPV water pumping systems may use any of the following types of motor pump sets:

- a) Surface mounted motor-pump set
- b) Submersible motor-pump set

3.4.2 The “Motor-Pump Set” should have a capacity in the range of 1 HP to 7.5 HP and should have the following features:

- a) The mono block DC/ AC centrifugal motor pump set with the impeller mounted directly on the motor shaft and with appropriate mechanical seals which ensures zero leakage.
- b) The motor of the capacity ranging from 1 HP to 7.5 HP should be AC/DC. The suction and delivery head will depend on the site specific condition of the field.
- c) Submersible pumps could also be used according to the dynamic head of the site at which the pump is to be used.

3.4.3 The pump and all external parts of motor used in submersible pump which are in contact with water, should be of stainless steel of grade 304 or higher as required. The motor-pump set should have a 5 years warranty and therefore, it is essential that the construction of the motor and pump should be made using parts which have a much higher durability and do not need replacement or corrode for at least 5 years of operation after installation.

3.4.5 The suction/ delivery pipe shall be of HDPE or uPVC column pipes of appropriate size, electric cables, floating assembly, civil work and other fittings required to install the Motor Pump set. In case of HDPE pipes the minimum pressure rating of 8 kg/sqcm-PE100 grade for pumps up to 3 HP, 10 kg/sqcm-PE100 grade for 5 HP pumps and further higher minimum pressure rating for above 5 HP as appropriate shall be used.

3.5 Module Mounting Structures and Tracking System

3.5.1 The PV modules should be mounted on metallic structures of adequate strength and appropriate design, which can withstand load of modules and high wind velocities up to 150 km per hour. The raw material used and process for manufacturing of module mounting structure including welding of joints should conform to applicable IS. The module mounting structure should be hot dip galvanized according to IS 4759. Zinc content in working area of the hot dip galvanizing bath should not be less than 99.5% by mass.

3.5.2 To enhance the performance of SPV water pumping systems arrangement for seasonal tilt angle adjustment and three times manual tracking in a day should be provided. In order to make structure rigid, the gap between Telescopic pattern supports should be minimal, further,



for bearing of center load of whole structure only pins should be used instead of threaded bolts.

3.5.3 The general hardware for structure fitment should be either SS 304 or 8.8 grade. Modules should be locked with antitheft bolts of SS 304 Grade. Foundation should be as per the site condition, based on the properties of Soil. Foundation can be done either with the help of ‘J Bolt’ (refer IS 5624 for foundation hardware) or direct piling, it should be decided as per the site and relevant IS i.e. IS 6403 / 456 / 4091 / 875 should be referred for foundation design.

3.5.4 Details of Module Mounting Structure for different capacity of SPV pumps are attached at Annexure-A. These are indicative of minimum standards and an Implementing Agency may specify higher standards.

3.6 SPV Controller

3.6.1 Maximum Power Point Tracker (MPPT) shall be included to optimally use the power available from the SPV array and maximize the water discharge.

3.6.2 The SPV Controller must have IP (65) protection or shall be housed in a cabinet having at least IP (65) protection.

3.6.3 Adequate protections shall be provided in the SPV Controller to protect the solar powered pump set against the following:

- a) Dry running;
- b) Open circuit;
- c) Accidental output short circuit;
- d) Under voltage;
- e) Reverse polarity;
- f) SPD to arrest high current surge; and
- g) Lightening arrestor.

3.6.4 A good reliable DC Circuit Breaker as per IS/IEC 60947-2 suitable for switching DC power ON and OFF shall be provided in the SPV Controller.

3.6.5 All cables used shall be as per IS 694. Suitable size of cable shall be used in sufficient length for inter-connection between the SPV array to SPV Controller and the SPV Controller to solar powered pump set. Selection of the cable shall be as per IS 14536.

3.6.6 Controller shall be integrated with GSM/GPRS Gateway with Geo tagging. GSM/GPRS Charges to be included in the Costing till the end of Warranty period of the Pump set.



3.7 Earthing Arrangement

3.7.1 Earthing of the motor shall be done as per IS 9283 in accordance with the relevant provisions of IS 3043. Separate earthing shall be provided for Controller, pump and SPV array.

3.7.2 For safety purpose, it shall be ensured during installation that the earthing is capable of taking care of leakage current.

3.7.3 In case of uPVC/HDPE pipes used as discharge pipe, a separate non-corrosive, low resistance conductor from motor earth terminal to control panel earth terminal shall be provided for earthing.

3.7.4 A lightning arrestor shall be provided with every SPV Water Pumping System.

3.8 Use of indigenous components

It will be mandatory to use indigenously manufactured solar modules with indigenous mono/multi crystalline silicon solar cells. Further, the motor-pump-set, controller and balance of system should also be manufactured indigenously. The vendor has to declare the list of imported components used in the solar water pumping system.

4. PERFORMANCE REQUIREMENTS

4.1 Under the “Average Daily Solar Radiation” condition of 7.15 KWh / sq.m. on the surface of PV array (i.e. coplanar with the PV Modules), the minimum water output from a Solar PV Water Pumping System at different “Total Dynamic Heads” should be as specified below :

For D.C. Motor Pump Set:

- i) 110 liters of water per watt peak of PV array, from a Total Dynamic Head of 10 meter (Suction head, if applicable, maximum of 7 meter) and with the shut off head being at least 12 meter.
- ii) 55 liters of water per watt peak of PV array, from a Total Dynamic Head of 20 meter (Suction head, if applicable, up to a maximum of 7 meters) and with the shut off head being at least 25 meter.
- iii) 38 liters of water per watt peak of PV array, from a Total Dynamic Head of 30 meters and the shut off head being at least 45 meter.
- iv) 23 liters of water per watt peak of PV array, from a Total Dynamic Head of 50 meter and the shut off head being at least 70 meter.
- v) 15 liters of water per watt peak of PV array, from a Total Dynamic Head of 70 meters and the shut off head being at least 100 meter.



- vi) 10.5 liters of water per watt peak of PV array, from a Total Dynamic Head of 100 meters and the shut off head being at least 150 meter.

The actual duration of pumping of water on a particular day and the quantity of water pumped could vary depending on the solar intensity, location, season, etc.

Indicative performance specifications for the Shallow and Deep well SPV Water Pumping Systems are given in the Annexure B.

For A.C. Induction Motor Pump Set:

- i) 99 liters of water per watt peak of PV array, from a Total Dynamic Head of 10 meter (Suction head, if applicable, maximum of 7 meters) and with the shut off head being at least 12 meter.
- ii) 49 liters of water per watt peak of PV array, from a Total Dynamic Head of 20 meter (Suction head, if applicable, up to a maximum of 7 meters) and with the shut off head being at least 25 meter.
- iii) 35 liters of water per watt peak of PV array, from a Total Dynamic Head of 30 meter and the shut off head being at least 45 meter.
- iv) 21 liters of water per watt peak of PV array, from a Total Dynamic Head of 50 meter and the shut off head being at least 70 meter.
- v) 14 liters of water per watt peak of PV array, from a Total Dynamic Head of 70 meter and the shut off head being at least 100 meter.
- vi) 9 liters of water per watt peak of PV array, from a Total Dynamic Head of 100 meter and the shut off head being at least 150 meter.

The actual duration of pumping of water on a particular day and the quantity of water pumped could vary depending on the solar intensity, location, season, etc.

Indicative performance specifications for the Shallow and Deep well SPV Water Pumping Systems are given in the Annexure C.

5. TESTS FOR HYDRAULIC AND ELECTRICAL PERFORMANCE OF PUMPSET

5.1 The motor-pump set shall be tested independently for hydraulic and electrical performance as per the relevant IS specification including following test

- a) Constructional requirements/features
- b) General requirements
- c) Design features
- d) Insulation resistance test
- e) High voltage test
- f) Leakage current test



5.2 Testing of SPV Water Pumping Systems shall be done as per procedure specified by the MNRE.

6. GUARANTEE OF PERFORMANCE

6.1 The SPV Water Pumping Systems shall be guaranteed for their performance of the nominal volume rate of flow and the nominal head at the guaranteed duty point as specified in 7.1 under the “Average Daily Solar Radiation” condition of 7.15 KWh/m² on the surface of SPV array (i.e. coplanar with the Photo Voltaic (PV) Modules). The actual duration of pumping of water on a particular day and the quantity of water pumped could vary depending on the solar intensity, location, season, etc.

6.2 Solar Photo Voltaic Water Pumping Systems shall be guaranteed by the manufacturer against the defects in material and workmanship under normal use and service for a period of at least 60 months from the date of commissioning.

6.3 Sufficient spares for trouble free operation during the Warrantee period should be made available as and when required

7. MARKING AND PARAMETERS TO BE DECLARED BY THE MANUFACTURER

7.1 The motor pump-set and Controller used in SPV Water Pumping Systems shall be securely marked with the following parameters declared by the manufacturer:

7.1.1 Motor Pump-set

- a) Manufacturer's name, logo or trade-mark;
- b) Model, size and SI No of pump-set;
- c) Motor Rating (kW / HP);
- d) Total head, m, at the guaranteed duty point;
- e) Capacity (LPD) at guaranteed head;
- f) Operating head range, m;
- g) Maximum Current (A);
- j) Voltage Range (V) and;
- k) Type - AC or DC Pump set; &
- l) Photo Voltaic (PV) Array Rating in Watts peak (W_p)

7.1.2 Controller

- a) Manufacturer's name, logo or trade-mark;
- b) Model Number;
- c) Serial Number;
- d) Voltage Range;
- e) Power Range in kW for Controller; and
- f) Current rating (A)



8. OPERATION AND MAINTENANCE MANUAL

8.1 An Operation and Maintenance Manual, in English and the local language, should be provided with the solar PV pumping system. The Manual should have information about solar energy, photovoltaic, modules, DC/AC motor pump set, tracking system, mounting structures, electronics and switches. It should also have clear instructions about mounting of PV module, DO's and DONT's and on regular maintenance and Trouble Shooting of the pumping system. Helpline number and Name and address of the Service Centre and contact number of authorized representative to be contacted in case of failure or complaint should also be provided. A warranty card for the modules and the motor pump set should also be provided to the beneficiary.

9. OTHER ACCESSORIES:

- i. **ON/OFF SWITCH:** A good reliable switch suitable for DC use is to be provided. Sufficient length of cable should be provided for inter- connection of the PV array, Controller/ Inverter and the motor pump set.
- ii. The supplier should also provide Standalone Lighting system consisting of 10 Watt solar panel with minimum efficiency of 14% and 10 years guarantee, 2 nos. of DC LEDs of 3 watt each and, USB Port facility for mobile through solar panel and ON-OFF switch with DC Socket (15A) for battery charging through the solar system. (Batteries will be provided by the beneficiary if required at his own cost)

10. COMPREHENSIVE OPERATION AND MAINTENANCE

- i. The Contractor should provide 5 years comprehensive maintenance of the Solar Photovoltaic Water pumping system set, which shall include corrective maintenance as well as routine service visits during guarantee period.
- ii. The service personnel of the Supplier shall make routine maintenance visits monthly for the first year and quarterly thereon till the completion period of comprehensive maintenance. The report has to be maintained. Apart from the monitoring, regular periodical maintenance of system has to be done. The report has to be maintained in a prescribed table format in a register maintained at the site which should contain Month, Inspection Date, Action taken against the Defects found in the System and Remarks of the representative of households along with signatures of both service Engineer and the farmer/ beneficiary.
- iii. The deputed personnel shall be in a position to check and test all the equipments regularly, so that preventive actions, if any, could be taken well in advance to save any equipment from damage.



- iv. Normal and preventive maintenance of the Solar Photovoltaic Water pumping systems such as cleaning of module surface, tightening of all electrical connections, changing of tilt angle of module mounting structure, cleaning & greasing of motor pump sets, changing filters etc. are also the duties of the deputed personnel during maintenance visits.
- v. During operation and maintenance period of the Solar Photovoltaic Water Pumping Systems, if there is any loss or damage of any component due to **miss management or miss handling** or due to any other reasons pertaining to the **deputed personnel**, what-so-ever, the supplier shall be responsible for **immediate replacement or rectification**. The damaged component may be repaired or replaced by new component.
- vi. The maintenance shall include replacement of any component irrespective of whether the defect was **a manufacturing defect or due to wear and tear**.

11. Performance Testing:-

- i. The bidder who qualifies in Technical bid shall perform the performance test for respective capacity of pumps for which he is qualified. After successful completion of performance test only, the bidder shall actually be eligible for his opening of financial bid. Failing which his price bid shall not be opened & he shall disqualify from further bidding process.
- ii. Performance test will be carried out by Bidder in presence of SNA's representative.
- iii. SNA will identify the site for testing of Solar Water Pumping System.
- iv. SNA will certify the performance test and will be the final authority.
- v. Bidder shall make complete necessary arrangement for performance testing of Solar Water Pumping System and standalone lighting system alongwith complete set of Apparatus, Equipment, Battery, Mobile, LED Bulbs etc. in all.

The result of performance test with **± 15 % variation** in the above indicative technical specifications will be accepted.



**Specifications for Dual Axis Manual Tracking Type
Module Mounting Structure (MMS) for Solar Water Pumping System**

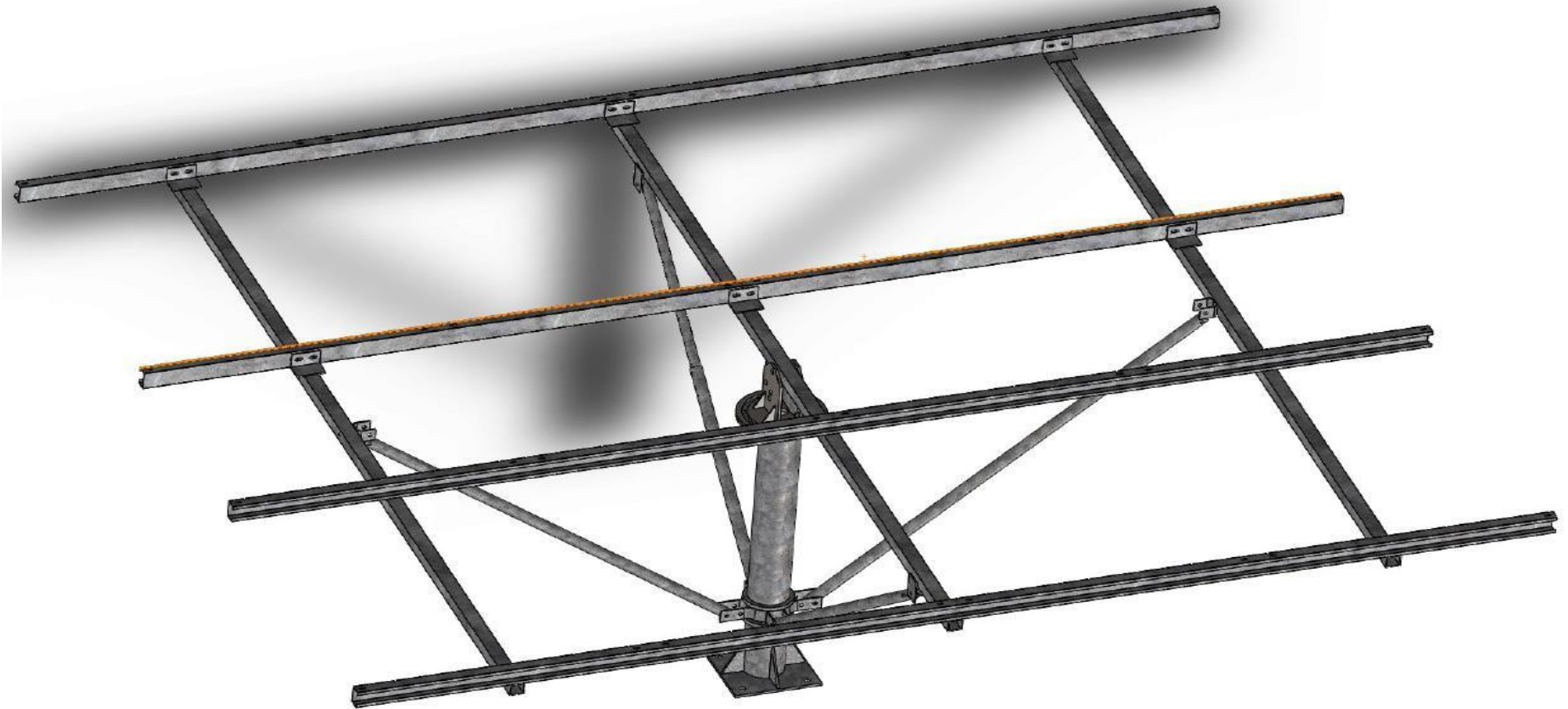

Signature :-
Subject : CN=DEEPAK MITTAL, ST=DELHI, OID.2.5.4.17=110003, OU=CONTRACTS AND
PROCUREMENT, O=ENERGY EFFICIENCY SERVICES LIMITED, C=IN
User ID : deepak.mittal

NIT/Bid Document No.: EESL/06/2019-20/KUSUM/SWPS/Phase-1/Off Grid/
192007012 Dated:- 18-07-2019

SECTION -4
Technical &
SCC

Page 25 of 102

Standard MMS for 4, 6 and 8 solar modules have been specified. These standard MMS may be used in combinations for different capacities of solar water pumping systems as follows:

1. Standard MMS of 4 Modules for 1 HP
 2. Standard MMS of 6 Modules for 2 HP
 3. Combination of standard MMS of 4 Modules and 6 Modules for 3 HP
 4. Combination of two standard MMS of 8 Modules for 5 HP
 5. Combination of three standard MMS of 8 Modules for 7.5 HP
- and so on....

Specifications of main parts used in MMS are given below:

1. Centre Shaft: - Centre shaft used in structure should be of minimum 139 OD with minimum thickness of 4 mm with base plate minimum 10 mm thickness if used and foundation hardware should be as per IS 5624. For system without base plate i.e. direct pilling is should be as per the site condition based on the properties of Soil and refer (IS 6403 / 456 / 4091 / 875) for foundation design.
2. Rafters: - The Main and secondary rafter used in structure should be of either SHS & RHS pipe sections.
3. Purlin: - Mounting Purlins used in the structure should be made of Cold form steel section as per IS 1079 with minimum thickness of 2mm.



4. Provision for Seasonal Tilt: - In one structure at least four telescopic supports (three may be used in MMS for 4 modules) either round hollow sections or square hollow section to be provided to support the mounting structure.
5. Provision for Daily Tracking: - Provision for Daily tracking should be provided by the way of providing min. 8 mm thick metal sheet with precision cut grooves.
6. Module Locking System: - Modules should be locked with antitheft bolts of SS 304 Grade.
7. General Hardware for Structure Fitment: - Either SS 304 or 8.8 grade hardware should be used for fitment.
8. Hot Dip Galvanizing: - All structure parts should be hot dip galvanized according to IS 4759.
9. Tolerance for fabrication: - Tolerance for fabrication of steel structure should as per IS 7215.
10. Welding: - Welding should be done as per IS: - 822 & grade of welding wire should be (ER70S-6).

Signature :-
Subject : CN=DEEPAK MITTAL, ST=DELHI, OID.2.5.4.17=110003, OU=CONTRACTS AND
PROCUREMENT, O=ENERGY EFFICIENCY SERVICES LIMITED, C=IN
User ID :- deepak.mittal

NIT/Bid Document No.: EESL/06/2019-20/KUSUM/SWPS/Phase-1/Off Grid/
192007012 Dated:- 18-07-2019

SECTION -4
Technical &
SCC

Page 27 of 102



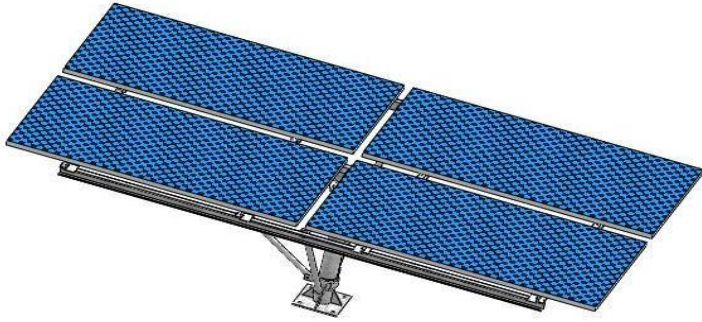

4 Module MMS

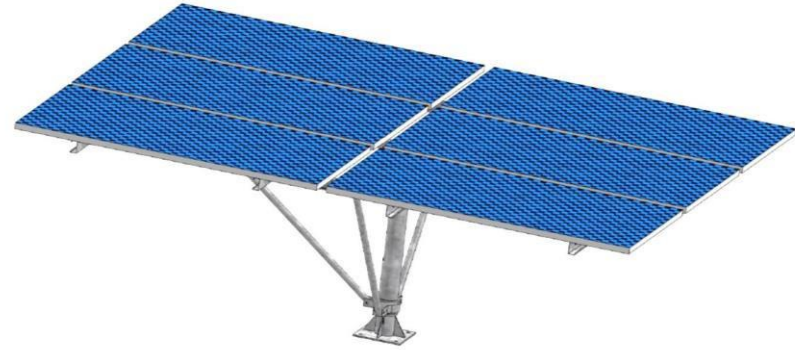

6 Module MMS

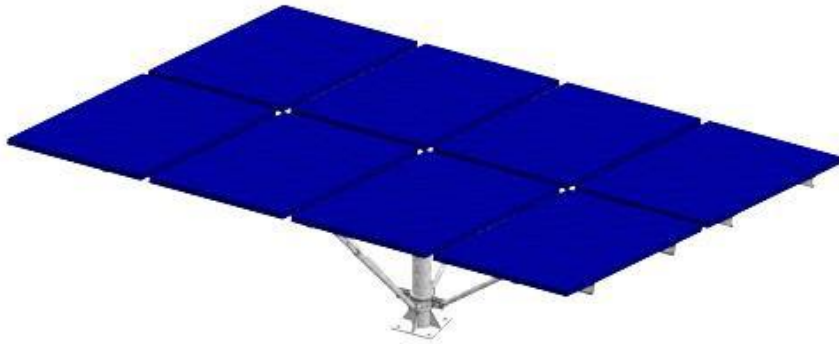

8 Module MMS



Side view

Signature :-
Subject : CN=DEEPAK MITTAL, ST=DELHI, OID.2.5.4.17=110003, OU=CONTRACTS AND
PROCUREMENT, O=ENERGY EFFICIENCY SERVICES LIMITED, C=IN

NIT/Bid Document No.: EESL/06/2019-20/KUSUM/SWPS/Phase-1/Off Grid/
192007012 Dated:- 18-07-2019

SECTION -4
Technical &
SCC

Page 28 of 102



Raw material test certificates (MTC) of all types of raw material used in dual axis manual tracking type MMS as per appropriate IS code should be submitted along with dispatch documents.

Tests to be performed on Dual Axis Manual Tracking Type MMS for Solar Water Pumping System: -

1. For ascertaining proper welding of structure part following should be referred.
 - a. Weld wire grade should be of grade **(ER 70 S - 6)**
 - b. D.P. Test (Pin Hole / Crack) **(IS 822)**
2. For ascertaining hot dip galvanizing of fabricated structure following should be referred: -
 - a. Min coating required should be as per IS 4759.
 - b. Testing of galvanized material.
 - i. Preece Test (CuSO₄ Dip Test) **(IS 2633)**
 - ii. Mass of Zinc **(IS 6745)**
 - iii. Adhesion Test **(IS 2629)**

Signature :-
Subject : CN=DEEPAK MITTAL, ST=DELHI, OID.2.5.4.17=110003, OU=CONTRACTS AND
PROCUREMENT, O=ENERGY EFFICIENCY SERVICES LIMITED, C=IN
User ID : deepak.mittal

	NIT/Bid Document No.: EESL/06/2019-20/KUSUM/SWPS/Phase-1/Off Grid/ 192007012 Dated:- 18-07-2019	SECTION -4 Technical & SCC	Page 29 of 102
--	--	----------------------------------	----------------

Part1 – Mail Column

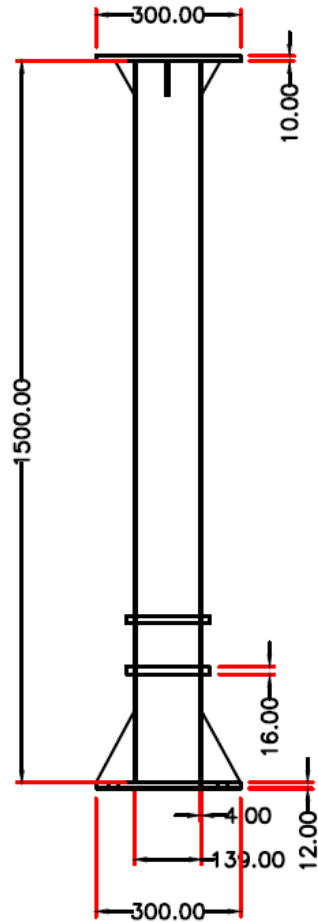

Notes: -

1. All Dimensions are in mm.
2. Main Column material grade should be YST - 240 as per: -IS: 1161 / 1239 & E250 as per: - IS: 1079 / 2062.

Signature :-
 Subject : CN=DEEPAK MITTAL, ST=DELHI, OID.2.5.4.17=110003, OU=CONTRACTS AND
 PROCUREMENT, O=ENERGY EFFICIENCY SERVICES LIMITED, C=IN
 User ID : deepak.mittal



Part 2 – Top Plate

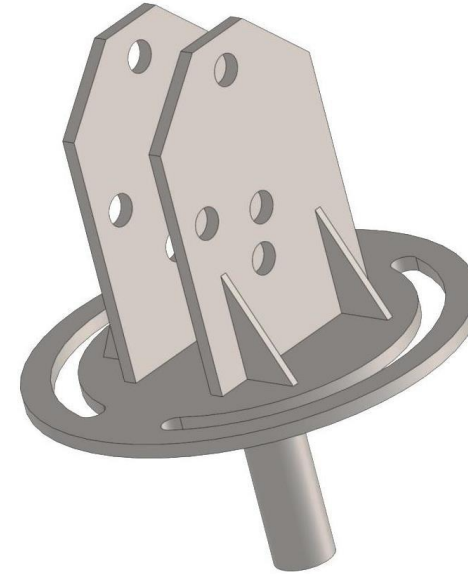
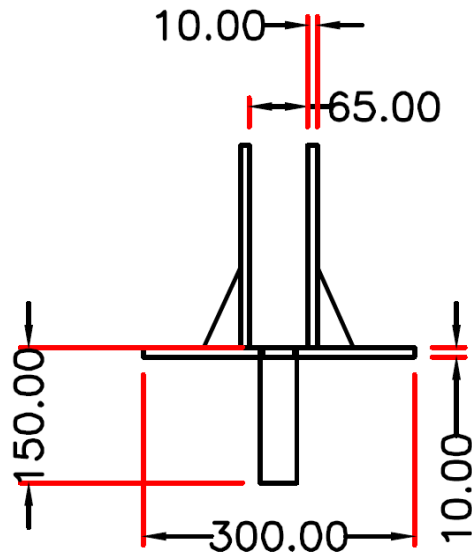

Notes: -

1. All Dimensions are in mm.
2. Top Plate material grade should be YST - 240 as per: -IS: 1161 / 1239 & E250 as per: - IS: 1079 / 2062.

Signature :-
 Subject : CN=DEEPAK MITTAL, ST=DELHI, OID.2.5.4.17=110003, OU=CONTRACTS AN
 PROCUREMENT, O=ENERGY EFFICIENCY SERVICES LIMITED, C=IN
 User ID : deepak.mittal



Part 3 – Main Tube

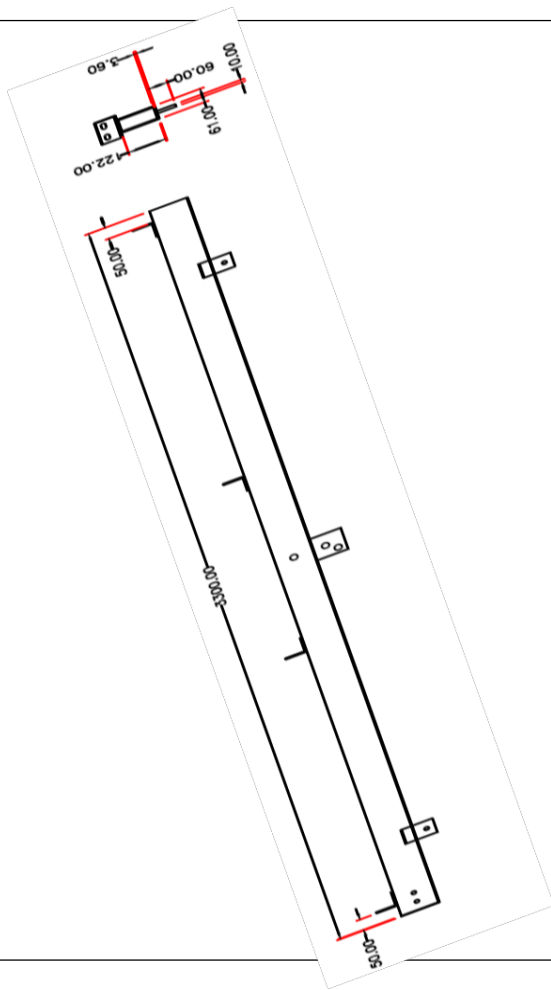

Notes: -

1. All Dimensions are in mm.
2. Main Tube material grade should be YST - 240 as per: -IS: 1161 / 1239 & E250 as per: - IS: 1079 / 2062.

Signature :-
 Subject : CN=DEEPAK MITTAL, ST=DELHI, OID.2.5.4.17=110003, OU=CONTRACTS AND
 PROCUREMENT, O=ENERGY EFFICIENCY SERVICES LIMITED, C=IN
 User ID : deepak.mittal



Part 4 – Side Tube

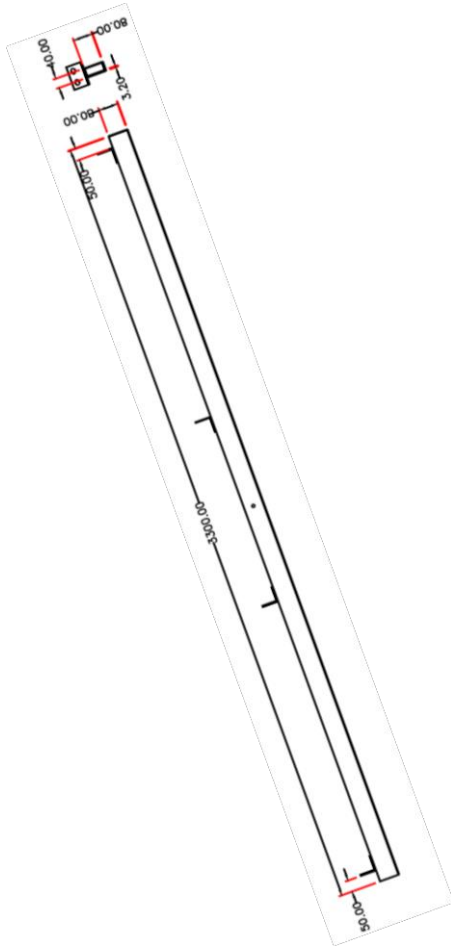

Notes: -

1. All Dimensions are in mm.
2. Side Tube material grade should be YST - 240 as per: -IS: 1161 / 1239 & E250 as per: - IS: 1079 / 2062.

Signature :-
 Subject : CN=DEEPAK MITTAL, ST=DELHI, OID.2.5.4.17=110003, OU=CONTRACTS AND
 PROCUREMENT, O=ENERGY EFFICIENCY SERVICES LIMITED, C=IN
 User ID : deepak.mittal



Part 5 – Purlin

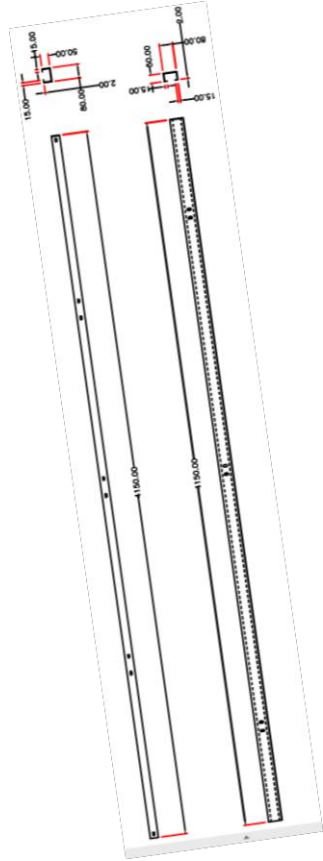

Notes: -

1. All Dimensions are in mm.
2. Mounting Purlin material grade should be E250 as per - IS: 1079 / 2062 & IS: 811.

Signature :-
 Subject : CN=DEEPAK MITTAL, ST=DELHI, OID.2.5.4.17=110003, OU=CONTRACTS AND
 PROCUREMENT, O=ENERGY EFFICIENCY SERVICES LIMITED, C=IN
 User ID : deepak.mittal



Part 6 – Clamp with Blade

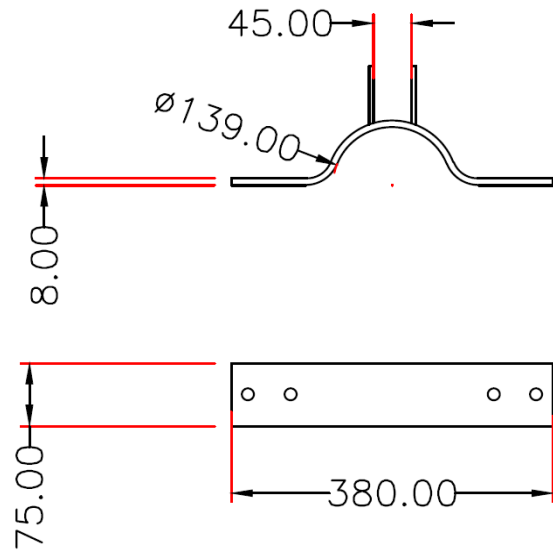

Notes: -

1. All Dimensions are in mm.
2. Clamp with Blade material grade should be as per: - IS: 1079 & E250 as per: - IS: 2062.

Signature :-
 Subject : CN=DEEPAK MITTAL, ST=DELHI, OID.2.5.4.17=110003, OU=CONTRACTS AND
 PROCUREMENT, O=ENERGY EFFICIENCY SERVICES LIMITED, C=IN
 User ID : deepak.mittal



Part 7 – Supporting Pipes

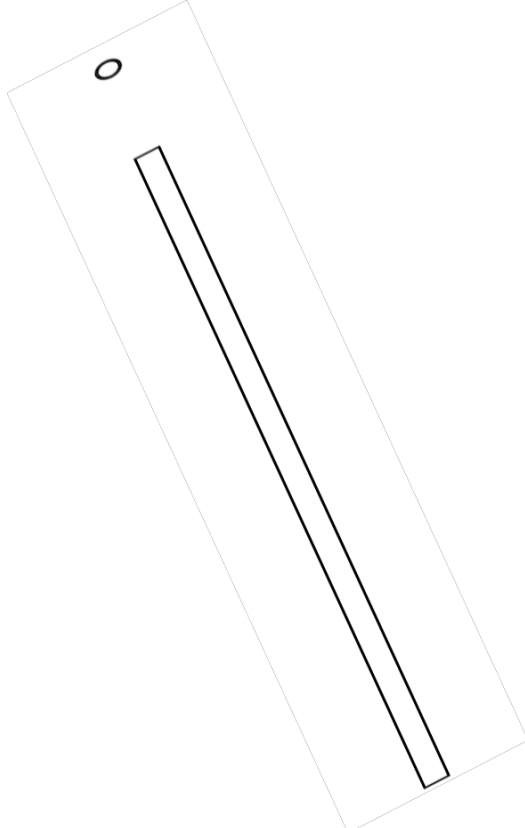

Notes: -

1. All Dimensions are in mm.
2. Supporting Pipes material grade should be YST - 240 as per: -IS: 1161 / 1239 & E250 as per: - IS: 1079 / 2062.

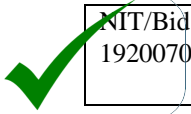

Bill of Quantity for main parts of MMS for Solar Water Pumping System

SR. NO.	PART NAME	CROSS SECTION DETAIL	LENGTH (MM)	QUANTITY PER SET
A	Common for MMS for 4, 6 and 8 Modules			
1.	MAIN POLE	139 OD	1500	1
2.	TOP PLATE	300 OD	--	1
3.	CLAMP WITH BLADE	75X8	380	2
4.	SUPPORTING PIPES	41 OD & 33 OD	--	6
B	Different for MMS for 4, 6 and 8 Modules			
5.	MAIN TUBE			
	4 and 6 Module	60X60X3.6	3300	1
	8 Modules	122X61X3.6	3300	1
6.	SIDE TUBE			
	4 and 6 Module	50X50X3.6	3300	2
	8 Modules	80X40X3.2	3300	2
7.	MOUNTING PURLIN			
	4 Module	80X50X15X2	2050	4
	6 Module	80X50X15X2	3100	4
	8 Modules	80X50X15X2	4150	4

Signature :-

Subject :- EESL DEEPAK MITTAL, SR DELHI, CID-254176110003, OUF-CONTRACTS-M

Doc ID :- 192007012

User ID :- deepak.mittal

IP :- 192.168.1.1

Browser :-

NIT/Bid Document No. :- EESL/06/2019-20/KUSUM/SWPS/Phase-1/Off Grid/
192007012 Dated:- 18-07-2019

SECTION -4
Technical &
SCC

Page 37 of 102



**ANNEXURE – B
(Continue)**

Indicative Technical Specifications of Solar Deep well (submersible) Pumping Systems with D.C. Motor Pump Set with Brushes or Brushless D.C. (B.L.D.C.)

Description	Model-I	Model-II	Model-III	Model-IV	Model-V	Model-VI	Model-VII	Model-VIII	Model-IX	Model-X	Model-XI	Model-XII	Model-XIII	Model-XIV
PV array (Wp)	1200	1800	3000	3000	3000	4800	4800	4800	6750	6750	6750	9000	9000	9000
Motor Pump-set capacity (HP)	1	2	3	3	3	5	5	5	7.5	7.5	7.5	10	10	10
Shut Off Dynamic Head (meters)	45	45	45	70	100	70	100	150	70	100	150	70	100	150
Water output * (Liters per day)	45600 (from a total head of 30 meters)	68400 (from a total head of 30 meters)	114000 (from a total head of 30 meters)	69000 (from a total head of 50 meters)	45000 (from a total head of 70 meters)	110400 (from a total head of 50 meters)	72000 (from a total head of 70 meters)	50400 (from a total head of 100 meters)	155250 (from a total head of 50 meters)	101250 (from a total head of 70 meters)	70875 (from a total head of 100 meters)	207000 (from a total head of 50 meters)	135000 (from a total head of 70 meters)	94500 (from a total head of 100 meters)

* Water output figures are on a clear sunny day with three times tracking of SPV panel, under the “Average Daily Solar Radiation” condition of 7.15 kWh/ sq.m. on the surface of PV array (i.e. coplanar with the PV Modules).

Notes:

1. For higher or lower head / PV capacity, or in between various models; water output could be decided as per the clause 4 (i.e. Performance Requirements) specified earlier.
2. If surface pumps are used in lieu of submersible pumps, the water output must match that of the submersible pumps as specified in this table.



ANNEXURE – C

Indicative Technical Specifications of Shallow Well (Surface) Solar Pumping Systems with A.C. Induction Motor Pump Set

Description	Model-I	Model-II	Model-III	Model-IV	Model-V	Model-VI	Model-VII	Model-VIII	Model-IX	Model-X	Model-XI	Model-XII	Model-XIII
PV array (Wp)	900	1800	2700	2700	4800	4800	4800	6750	6750	6750	9000	9000	9000
Motor Pump-set capacity (HP)	1	2	3	3	5	5	5	7.5	7.5	7.5	10	10	10
Shut Off Dynamic Head (meters)	12	12	12	25	12	25	45	12	25	45	12	25	45
Water output * (Liters per day)	89100 (from a total head of 10 meters)	178200 (from a total head of 10 meters)	267300 (from a total head of 10 meters)	132300 (from a total head of 20 meters)	475200 (from a total head of 10 meters)	235200 (from a total head of 20 meters)	168000 (from a total head of 30 meters)	641025 (from a total head of 10 meters)	330750 (from a total head of 20 meters)	236250 (from a total head of 30 meters)	890000 (from a total head of 10 meters)	441000 (from a total head of 20 meters)	324000 (from a total head of 30 meters)

* Water output figures are on a clear sunny day with three times tracking of SPV panel, under the “Average Daily Solar Radiation” condition of 7.15 kWh/ sq.m. on the surface of PV array (i.e. coplanar with the PV Modules).

Notes:

1. Suction head, if applicable, maximum 7 meters.
2. For higher or lower head / PV capacity, or in between various models; water output could be decided as per the clause 4. (i.e. Performance Requirements) specified earlier.
3. If submersible pumps are used in lieu of surface pumps, the water output must match that of the surface pumps as specified in this table.

Signature :-
 Subject : CN=DEEPAK MITTAL, ST=DELHI, OID.2.5.4.17=110003, OU=CONTRACTS AND
 PROCUREMENT, O=ENERGY EFFICIENCY SERVICES LIMITED, C=IN
 User ID : deepak.mittal
 Serial No : F3FA77

NIT/Bid Document No.: EESL/06/2019-20/KUSUM/SWPS/Phase-1/Off
 Grid/ 18072019 Dated:- 18-07-2019

SECTION –4 Technical
& SCC

Page 42 of 102



ANNEXURE – C
(Continue)

Indicative Technical Specifications of Solar Deep well (submersible) Pumping Systems with A.C. Induction Motor Pump Set

Description	Model-I	Model-II	Model-III	Model-IV	Model-V	Model-VI	Model-VII	Model-VIII	Model-IX	Model-X	Model-XI	Model-XII	Model-XIII	Model-XIV
PV array (Wp)	1200	1800	3000	3000	3000	4800	4800	4800	6750	6750	6750	9000	9000	9000
Motor Pump-set capacity (HP)	1	2	3	3	3	5	5	5	7.5	7.5	7.5	10	10	10
Shut Off Dynamic Head (meters)	45	45	45	70	100	70	100	150	70	100	150	70	100	150
Water output * (Liters per day)	42000 (from a total head of 30 meters)	63000 (from a total head of 30 meters)	105000 (from a total head of 30 meters)	63000 (from a total head of 50 meters)	42000 (from a total head of 70 meters)	100800 (from a total head of 50 meters)	67200 (from a total head of 70 meters)	43200 (from a total head of 100 meters)	141750 (from a total head of 50 meters)	94500 (from a total head of 70 meters)	60750 (from a total head of 100 meters)	189000 (from a total head of 50 meters)	126000 (from a total head of 70 meters)	81000 (from a total head of 100 meters)

* Water output figures are on a clear sunny day with three times tracking of SPV panel, under the “Average Daily Solar Radiation” condition of 7.15 kWh/ sq.m. on the surface of PV array (i.e. coplanar with the PV Modules).



Guidelines on Testing Procedure for Solar Photovoltaic Water Pumping System

1 SCOPE

These Guidelines lays down basis for testing set up and testing procedures for Solar Photovoltaic (SPV) water pumping system. The SPV water pumping system covered are centrifugal pumps of all types up to 10 HP capacity.

2 REFERENCE STANDARDS

The Indian and IEC Standards listed at Annex A contain provisions which, through reference in this text, constitute provision of this standard. Latest editions of the indicated standards should be considered.

3 DEFINITION OF SYSTEMS AND PARAMETERS

3.1 Systems

3.1.1 Stand-Alone Solar PV Water Pumping System

A Solar PV Water Pumping System in stand-alone operation is neither connected to the grid nor to battery bank and is comprised mainly of the following components and equipment:

PV Modules, cabling, controller, motor pump-set and hydraulic piping. Combination of all these components shall be unique. Any change in combination will be treated as different model of pumping system.

3.1.2 Motor-Pump Set

The Motor-pump set consists of the pump (centrifugal pump) and the driving motor.



3.1.3 Controller

The controller converts the DC power (DC voltage & Current) of the PV array into a high or low DC voltage power, or converts this DC power into single -phase or multi-phase alternating-current power (voltage or alternating current) suitably for driving the motor of Motor-pump set.

NOTE — The Controller may also include equipment for MPPT, monitoring, metering and for protection purposes.

3.2 Parameters

Following parameter shall be referred during testing of SPV pumping system:

NIT/Bid Document No.: EESL/06/2019-20/KUSUM/SWPS/Phase-1/Off Grid/18072019 Dated:- 18-07-2019 <small>Signature Subject : CN=DEEPAK MITTAL, ST=DELHI, OID.2.5.4.17=110003, OU=CONTRACTS AND PROCUREMENT, O=ENERGY EFFICIENCY SERVICES LIMITED, C=IN User ID : deepak.mittal Serial No : F3FA77</small>	SECTION –4 Technical & SCC	Page 45 of 102
---	-------------------------------	----------------



Table 1 – Parameters		
Parameter	Symbol	Unit
(1)	(2)	(3)
Array voltage (DC)	V_a	V
Array current (DC)	I_a	A
Array open circuit voltage (DC)	V_{oc}	V
Array short circuit current (DC)	I_{sc}	A
Array maximum power point voltage(DC)	V_{mpp}	V
Array maximum power point current (DC)	I_{mpp}	A
Pressure as measured	p	kg/cm ²
Flow rate	Q	Lps /Lpm /m ³ h
Motor voltage DC or AC	V_m	V
Motor current DC or AC	I_m	A
Motor voltage (multi-phase AC)	V_{rms}	V
Motor current (multi-phase AC)	I_{rms}	A
Power factor	$\cos\phi$	-
AC frequency (or DC switching frequency)	F	Hz
Motor speed	N	min ⁻¹
Radiation	E_e	W/m ²
Temperature	T	°C

4 TEST SET UP

4.1 Test Set-Up

Illustration(s) of test set-ups are shown in Figure 1 & Figure 2, and a block diagram of required test set-up is shown in Figure 3. All test set-ups shall conform to applicable model test set-ups referred above and the water level in the sump well, locations of throttle valve, flow meter and pressure gauge/sensor connections as indicated in the test set-up(s) shall conform to Figure 1, Figure 2 & Figure 3 accordingly.

4.2 Precautions for Test Setup:

Before initiating testing of SPV pump the following precautions must be followed:

- In case of direct coupled pump-set, proper alignment of input pipe, output pipe and the sensors shall be ensured.



- b) Air tightness in suction line shall be ensured and the general layout of the system pipe work should be designed to avoid airlocks.
- c) The offset pipe of suction line shall either be horizontal or inclined upward towards the pump and shall never be inclined downward towards the pump to avoid air trapping.
- d) For the delivery head, a pressure gauge/sensor shall be connected to the delivery line with tapping as shown in Figures 1 or 2 or 3. The tapping shall be flush with the inside of the pipe and shall have its axis at right angles to the direction of flow. The pipe set up between the pump outlet and the pressure sensor should be the same diameter as the manufacturer's outlet fitting. Sensor/gauge may be connected to the tapping point through a flexible hose.
- e) Preferably, Digital Pressure sensor/gauges of suitable range need to be used for the measurement of head. Care shall be taken to eliminate any leaks in the connecting pipes and to avoid the trapping of air in the connecting pipe or hose.
- f) It is assumed that over the normal operating range of the pump the pressure drop due to frictional losses between the pump outlet and the pressure sensor will be negligible and the kinetic energy component of the water at the pump outlet will be small compared to the increase in potential energy due to the increased pressure across the pump.
- g) For instantaneous performance testing, pressure can be sustained by means of a simple gate valve in which a backpressure is sustained by restricting the flow. An automatic control valve(s) may be used to sustain a constant upstream pressure. Pressure may also be sustained by means of a pre-pressurized air chamber operating with a pressure maintaining valve at the outlet. A real water column may also be used.
- h) A good quality digital flow meter with electrical output linearly proportional to flow rate shall be connected at the other end of the delivery pipe. The distance between the auto control valve and flow meter shall be minimum 1.5 meters to ensure laminar flow of water.
- i) After flow meter the end of the discharge pipe should be beneath the water surface to prevent splashing. This could cause a mixed water / air bubbles fluid entering the pump inlet and affecting its proper operation. If so then a vertical baffle or a similar arrangement shall be inserted in the tank between the pump intake and the return pipe such that water does not make any splash and avoid any bubbles when spread to the bottom of tank to reach the input pump. In this way any small bubbles will be excluded, as they will remain near the surface. Alternatively a large pipe can be placed around the pump with its top breaking the surface and an arch cut in its base to allow water entry.

4.3 Priming Arrangement

A non-return valve/ foot valve shall be used in suction line, further it may also require suction pipe need to be filled with water for priming purpose in case of surface pumps.

4.4 PV Module Array Structures:

For testing the SPV pump using the actual solar array, outdoor PV array structures with different module mounting capacity (4,6,8,10, etc.) should be used. The modules are mounted on the structures with tracking facility to optimize irradiance, power output and accordingly, the total quantity of water pumped in a day.

4.5 Sun Simulator PV Module Tester:

To estimate the wattage of the PV modules under STC, a high precession (at least class AAA as

NIT/Bid Document No.: EESL/06/2019-20/KUSUM/SWPS/Phase-1/Off Grid/18072019 Dated:- 18-07-2019 <small>Signature Subject : CN=DEEPAK MITTAL, ST=DELHI, OID.2.5.4.17=110003, OU=CONTRACTS AN PROCUREMENT, O=ENERGY EFFICIENCY SERVICES LIMITED, C=IN User ID : deepak.mittal Serial No : F3FA77</small>	SECTION –4 Technical & SCC	Page 47 of 102
--	-------------------------------	----------------



per IEC 60904-9) sun simulator module tester is required in the pump testing lab. Alternatively, all PV modules should have STC testing certificate from an NABL accredited test laboratory and the date of testing should not be later than a year. In the STC testing, if the module is found degraded, the degraded data should be used.

4.6 Simulator (Electrical) Testing

Ideally, the SPV pump should be tested as per the site conditions where it is designed to operate. The details of outdoor testing are discussed in the next sessions. However, for testing under simulated conditions, a programmable Solar PV (SPV) array simulator capable of simulating a given solar PV array configuration (i.e. the number of modules, the type and the series / parallel combination), site radiation and temperature conditions shall be required for laboratory. Measurement equipment with acceptable accuracy and precision shall be used for detection and data logging of the parameters listed in Table 2.

Table 2 – Core Parameters to be Measured and Recorded			
Parameter	Symbol	Unit	Measurement Uncertainty
(1)	(2)	(3)	(4)
SPV Array voltage	V_a	V	≤1 percent
SPV Array current	I_a	A	≤1 percent
Pressure/head as measured	p	Kg/cm ²	≤2 percent
Flow rate	Q	lps	≤2 percent
Solar irradiance	E_e	W/m ²	≤2 percent

4.7 Sump Well (Hydraulic Testing)

For the performance testing of SPV pumps a sump well with sensors for sensing, monitoring and recording of pump parameters will be required. The details of the resources required are given below:

- a) Water tank / sump of required dimensions,
- b) PV Modules, Controller, Motor-pump set, and Other Accessories (Test Sample)
- c) Pressure transducer with data logging system
- d) Flow Meter with data logging system
- e) Suction pipe(s) (if applicable)
- f) Discharge pipe(s)
- g) Pyranometers and Temperature sensors with data logging system
- h) Auto control valves
- i) SPV array Simulator(s) for simulation of module arrays for testing
- j) SPV array for realistic testing
- k) Structure for mounting modules for realistic condition testing
- l) AAA class Sun simulator for testing of modules performance at STC

Refer to the block diagram at Figure 3.



4.8 Constant Head Requirement

Dynamic head variation during test shall be within limit as specified in column 2 of table 3 and the allowable variation in arithmetic average (from start of flow point to end of flow point refer figure 5) of dynamic head shall be within value specified in column 3 of table 3. Any data with head variation during the test beyond the limit specified in column 2 of table 3 shall be treated as garbage data and shall not be considered in calculations of daily water output.

Table 3– Allowable variation in arithmetic average of dynamic head		
Required Dynamic head in (meters)	Allowable variation in dynamic head during test	Allowable variation in arithmetic average of dynamic head
(1)	(2)	(3)
10	± 15 % = ± 1.5 meter	± 0.5 meter
20	± 10 % = ± 2 meter	± 0.5 meter
30	± 10 % = ± 3 meter	± 0.7 meter
50	± 8 % = ± 4 meter	± 0.8 meter
70	± 7 % = ± 4.9 meter	± 0.8 meter
100	± 7 % = ± 7 meter	± 1 meter



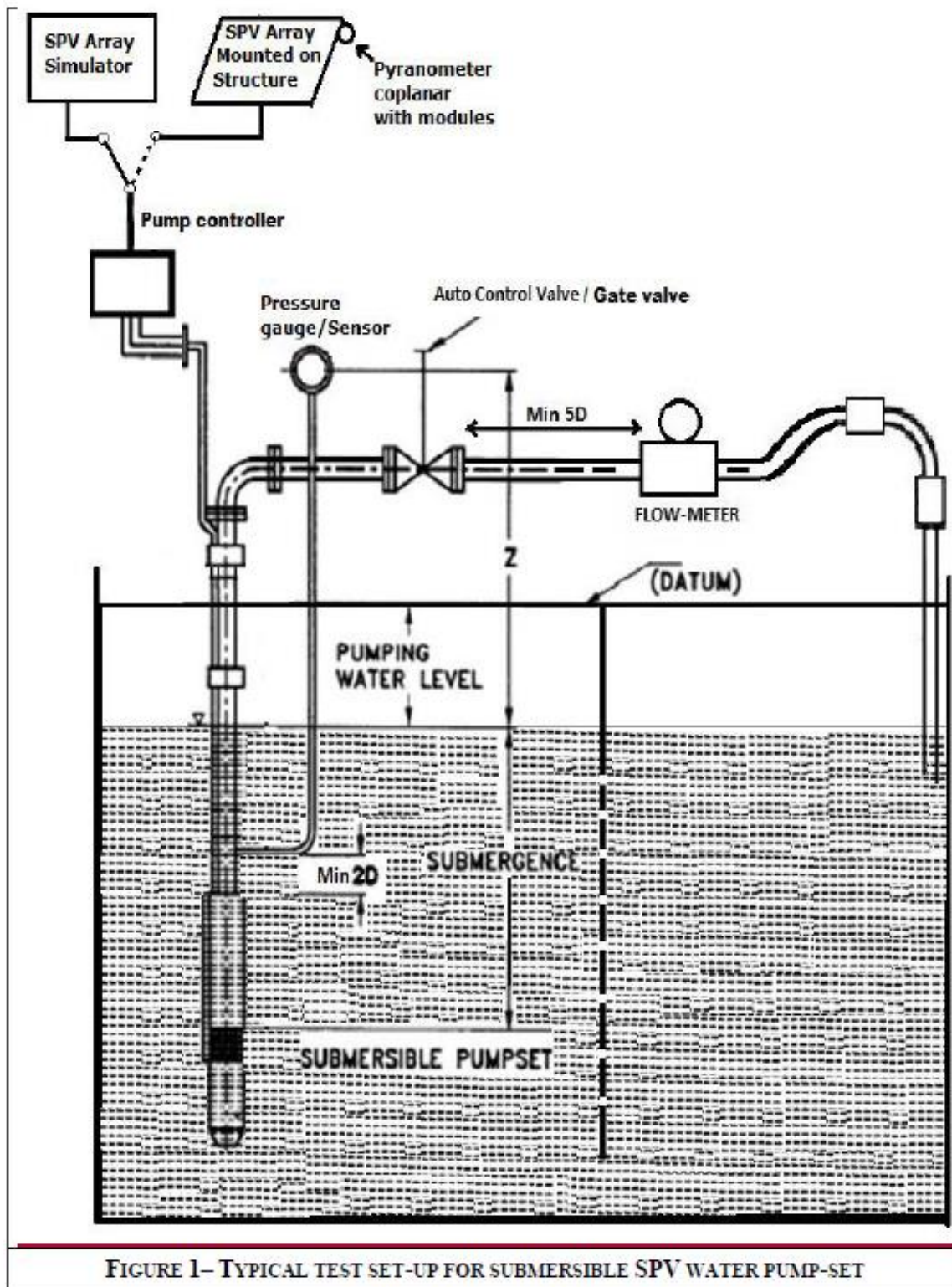
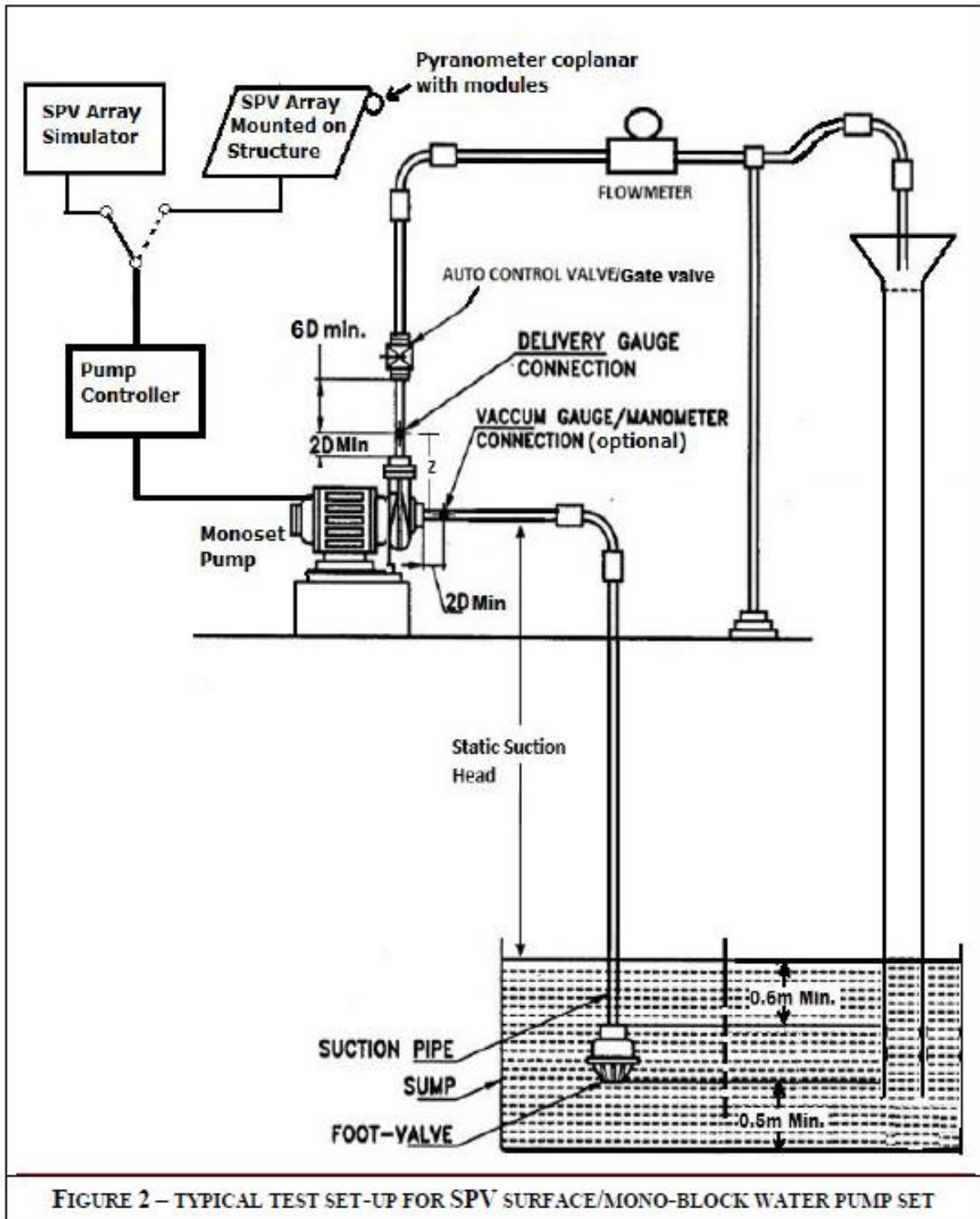

FIGURE I- TYPICAL TEST SET-UP FOR SUBMERSIBLE SPV WATER PUMP-SET





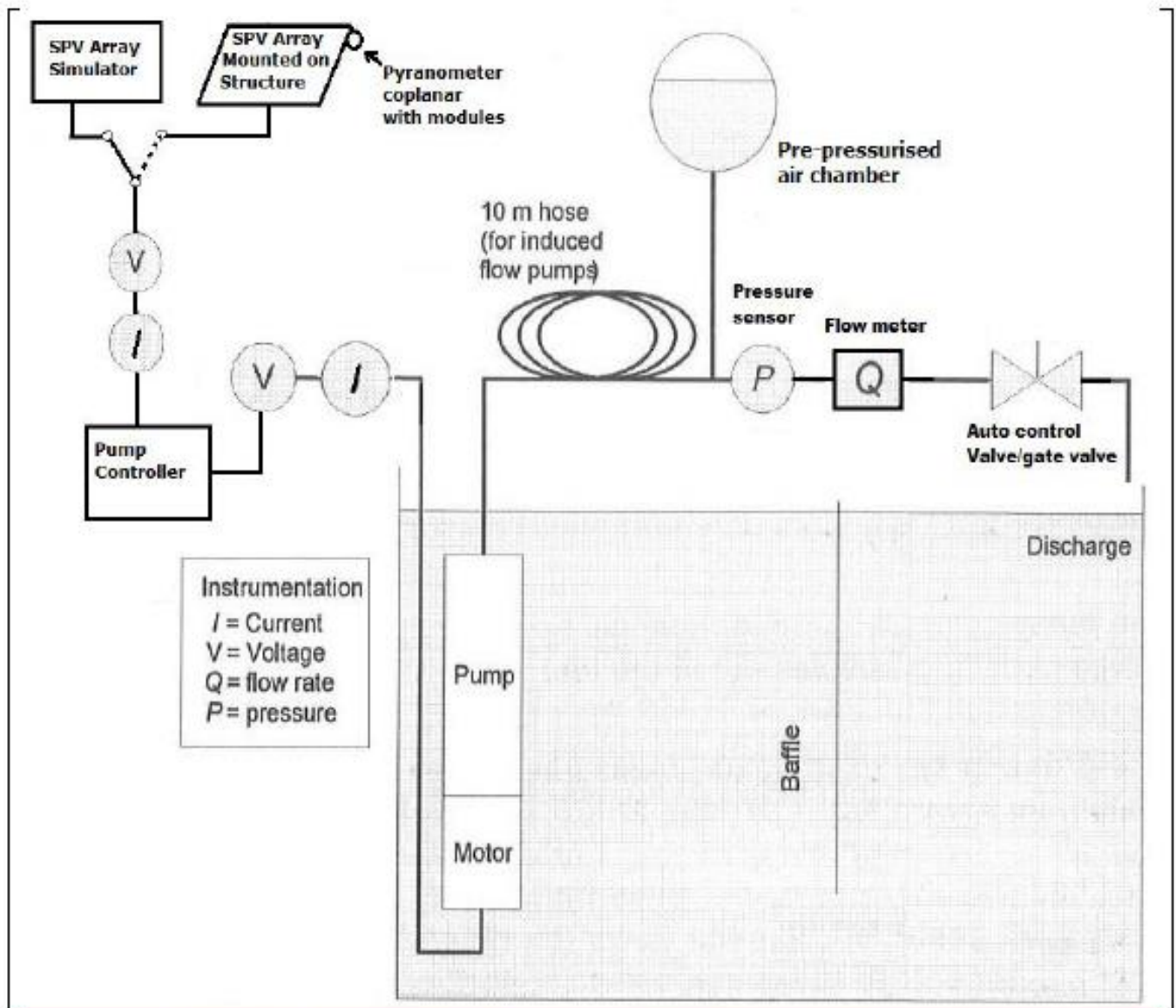
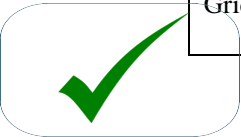

FIGURE 3 – BLOCK DIAGRAM OF TEST SETUP FOR SUBMERSIBLE PUMP-SET



5.0 Test Procedure for Performance Evaluation of SPV Pumping System:

There are three major profiles to be completed for comprehensive certification and qualification of a sample SPV water pump as per this standard. Two steps correspond to two simulation profiles, Hot & Cold. The third step corresponds to actual outdoor conditions testing using natural sun radiation. The SPV water pump sample should attain or exceed the qualification bench marks set by MNRE for the specified model & design, in all the three profiles. Before executing the three profiles testing, it is necessary to conduct the following protections test on the sample:

1. Dry running: System must shut down within one minute/manufacturer specification in dry running condition (when water level goes below pump inlet).
2. Open circuit: System should not operate if any phase become open circuited, the controller shall be tripped within one minute/manufacturer specified time.
3. Short circuit: System should not operate if any two or all three phase short circuited.
4. Reverse polarity: System should not malfunction if polarity of input power is reverse.

The performance testing of SPV Pumping System for the three procedures are discussed in following sections:

5.1 Simulator Methods:

Simulation methods are the easiest and fastest way of estimating SPV pump performance. However, in these methods actual PV array is not used, instead a PV array simulator is used. Here, a Programmable SPV array simulator capable of generating power output equal to actual SPV array under the given radiation and temperature conditions for given SPV array configuration (i.e. the number of modules, the type and the series / parallel combination) will be used. Although any radiation & temperature can be created, for the purpose of testing, two conditions one Hot summer day conditions (hot profile) and the other Winter day conditions (cold profile) shall be used.

Hot & Cold Profiles:

The typical Hot & Cold day profiles are shown Figure 4. These profiles of full day Solar irradiance and temperature shall be loaded in PV array simulator, sequentially one after the other. The simulator output is connected to the motor & pump through the pump controller and the profiles are run on real time basis. The performance parameters as given in table 2 are collected every minute for the entire duration of run time (per day). The total water output and output in liters /watt STC/ day can be estimated at desired constant head / dynamic head for complete duration of profiles.



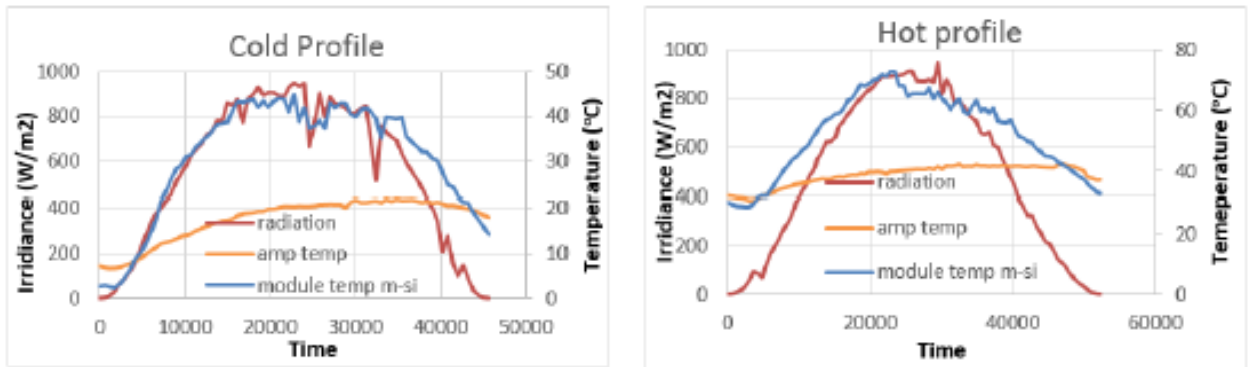

FIGURE 4 – TYPICAL SOLAR RADIATION HOT AND COLD PROFILE

Note: Per second data for hot and cold profile may be downloaded from MNRE/NISE website

5.2 Outdoor Condition using sun radiation:

To operate the motor-pump set using actual PV array, an array as per the Motor-pump set HP capacity to be designed. The STC wattage of all the PV modules is measured first, as per IEC 60904-1/ IS 12762-1 or clause number 11.6 of IEC 61215/ clause number 10.6 IS1 4286. . The modules will then be installed on the structures, both in series and parallel combinations, as required, are connected and designed PV module array is created. The array output is connected to Motor & Pump through pump controller. Then using a PV Array tester measure the PV array output and different radiation intensities starting 100W/ m² up to 1000 W/m² (if possible), if 1000W/ m² is not reached, calculate maximum power output at the maximum sun radiation that can be achieved (say 900 or 800w/ m²). Always measure & record the instantaneous water flow rate at each of the radiation levels, against the PV array output power. A Table listing three parameters sun radiation, array Wattage output and water flow rate at each power output to be recorded. This data is most useful and will be used in subsequent calculations. This data can also be compared with data supplied by manufacturer.

Per day water output test to be performed at desired constant dynamic head for complete day from dawn to dusk (sunrise to sunset). Irradiance shall be measured at coplanar to modules. Tracking may be done manually or automatically. Total flow shall be corrected at reference Average Daily Solar Radiation of 7.15 kWh/m² on the surface of SPV array (i.e. coplanar with the SPV Modules). Results of the SPV pumping system obtained under outdoor condition shall be compared with data supplied by the applicant and also from the results obtained through simulator testing to assess the performance of the system.



NOTE:-

- Handle PV modules carefully during installation.
- PV modules to be free from dirt (sand, bird droppings etc.,) during test.
- Install PV modules in shadow free access controlled area.
- Tracking shall be minimum three time in a day for maximum performance
- Pyrono-meter should be mounted co-planer with SPV modules.

Recoding, measurement & logging of flow for the period of hot profile, cold Profile and Realistic condition need to be done.

5.3 Remote Monitoring System Verification

Provision for remote monitoring of the installed pumps must be made in the controllers through an integral arrangement and it should be capable of providing live status/parameters through online portal.

6 MEASUREMENTS AND APPARATUS**6.1 Solar Radiation Measurement**

Solar radiation at coplanar with Module surface shall be measured using pyranometer. Response time of pyranometer should not be more than 15 seconds. Interval between two readings should not be more than one minute for the calculation of average daily solar radiation.

6.2 Measurement of Head**6.2.1 Delivery Head**

Digital pressure gauge/sensor shall be used, also a data logging system must be used for calculation of average head through day. Interval between two readings should not be more than one minutes for the calculation of average head. Accuracy for pressure sensor shall be within ± 0.5 percent.

6.2.2 Suction Head

Suction head shall be kept constant by mean of vertical distance from sump water level to centre of pump impeller. Correction in head shall be applied as per atmospheric pressure at the testing place.

Distance measuring scale or laser based sensors may also be used for suction head measurement. For reference a vacuum gauge/absolute pressure gauge/manometer may also be used, if used, then shall be of suitable range for measuring suction head and delivery heads. Instead of mounting gauges directly on the pipes, they may be placed on separate stand.



6.3 Measurement of Rate of Flow

A good quality Magnetic flow-meter is desirable for flow measurement, data logging system must be used for calculation of cumulative water volume throughout the day. The maximum flow rate of flowmeters should be at least 1.5 times the maximum flow rate of pumps. Instrument can be selected as per 3.2 of IS 11346. Interval between two readings should not be more than one minutes for the calculation of cumulative flow. Accuracy for flowmeters shall be within ± 0.5 percent.

7 CALIBRATION OF APPARATUS

All measuring instruments are to be calibrated periodically as per requirement.

8 STEP-WISE TEST PROCEDURE

8.1 Per Day Water Flow Test of Submersible Pumps

- a) Install the Pump-set as per Figure 1.
- b) Connect Pump-set with controller as per manufacturer instruction
- c) Use Solar PV Array Simulator Or actual output from SPV array, for testing of pump-set at given profile.
- d) Connect controller with PV array Simulator or with actual SPV array output as per requirement of profile
- e) Input STC performance data of each module in the array, into simulator and invoke the desired profile and run the same.
- f) For realistic condition test, make array by mounting all SPV modules on structure(s) by connecting modules in series or parallel as per requirement.
- g) Start controller after connecting it with array or array simulator.
- h) Use head control valve or pre-pressurize tank to keep constant desired dynamic head.
- j) Record parameters as given in table 2 recording interval shall be ≤ 1 minute.

8.2 Per Day Water Flow Test of Surface Pumps

- a) Install pumps as per Figure 2



- b) Maintain height to get desirable static suction head as per requirement
- c) Install of foot valve or non-return valve as per manufacturer instructions;
- and d) Follow steps (b) to (j) of para No. 8.1

9 OBSERVATIONS

The following observations of complete day profile shall be recorded in a test record sheet. These observations shall be used to derive pump characteristics:

- a) Instantaneous Solar irradiation (W/m^2), pyranometer reading
- b) Delivery gauge/sensor readings
- c) Suction gauge/sensor readings / Distance between water level to impeller eye, (if applicable)
- d) Gauge distance correction factor, Z
- e) Calculate cumulative daily solar radiation coplanar with solar modules (kWh/m^2), f) Calculate total water discharge in a day at desirable constant head (Liters per Day) g) Water output per day per watts peak (Liters/Wp)

10 COMPUTATION OF TEST READINGS

10.1 Computation of Total Head for Surface (Mono-set) Pumps

$$\text{Total Head } H = H_{SSL} + H_d + Z + ((V_{ds}^2 - V^2) / 2g)$$

H_{SSL} = Total Static suction Lift in meters of water column (measured by calibrated measuring tape or any distance measuring sensors)

H_d = Delivery gauge/sensor reading in meters of water column

Z = Gauge distance correction factor for delivery gauge centre and inlet pipe centre in meters (refer figure 3). If the delivery gauge centre is below the inlet pipe centre, Z is subtracted from the delivery gauge reading and if the delivery gauge centre is above inlet pipe centre, Z is added to the delivery gauge reading; the gauge distance correction factor shall never be applied to the suction vacuum gauge or mercury manometer reading irrespective of their positions:

V_d = Velocity at delivery gauge/sensor connection, m/s;

V_s = Velocity at suction gauge/sensor connection, m/s;



and g = Acceleration due to gravity in m/s^2 .

The Total Static Suction Lift in surface pump (H_{SSL})

H_{SSL} = Height in meter from water level to impeller + Altitude correction in meter + water temperature correction in meter.

10.1.1 Correction for Altitude

Barometric pressure shall be recorded at test place. The difference between atmospheric pressure at the test place and 10.33 mWC (that is atmospheric pressure at MSL) shall be deducted from Static suction lift.

10.1.2 Correction for Water temperature

Static suction lift specified in below Table shall be increased or reduced as given below when water temperature is below or above 33°C.

Table 4 – Correction for water temperature

Hourly Average of Water Temperature °C	Vapour pressure mWC	Correction in Static suction lift above and below 33°C water temperature mWC
10	0.13	+ 0.39
15	0.18	+ 0.34
20	0.24	+ 0.28
25	0.33	+ 0.19
30	0.43	+ 0.09
33	0.52	0.00
35	0.58	- 0.06
40	0.76	- 0.24
45	1.00	- 0.48
50	1.28	- 0.76

Suction head shall be adjusted minimum 3 time in a day as per average water temperature and barometric pressure, by adjusting water level of tank.

Following formula can also be used on behalf of

$$\text{table 4 } y = -0.0007 x^2 + 0.0130 x + 0.3079$$

Where y = Correction in Static suction lift x = Average of water temperature.



10.2 Computation of Total Head for Submersible Pump-sets

$$\text{Total head } H = H_d + Z + ((V_d^2) / 2g)$$

Where:

H_d = Delivery gauge/sensor reading in meters of water column;

Z = Gauge distance correction factor for delivery gauge. Distance between gauge/sensor center to tank water level (refer figure 1).

V_d = Velocity at delivery gauge/sensor connection in m/s;

g = Acceleration due to gravity in m/s^2 .

10.3 Total Water Per-Day

Total per day water output shall be calculated by Integration (Sum) of flow rate with respect to time. Integration shall start from the time when pump set achieve desired constant head in morning time (start point refer figure 5) and end at the time when pump set unable to achieve desired constant head in evening time (End point refer figure 5).

In case if Average Daily Solar Radiation found less than requirement then test shall be performed on next sunny day.

10.4 Water Output Per Day Per Watt Peak

Water output per day per watts peak (ltr/Wp) = Water output (Liters) per day at specified head / Array STC power in watts-peak

10.5 Cumulative Daily Solar Radiation

Cumulative Solar Radiation (kWh/m^2) in a day= Average of instantaneous irradiance reading from

Dawn to Dusk (kW/m^2) X period of time in hours.

This can be obtained through time weight summation of pyranometer

readings. Dawn = Time of sunrise when irradiance become positive from

zero value.

Dusk = Time of sunset when irradiance become zero from positive value.

10.6 Mismatch in maximum power at STC among modules of array

NIT/Bid Document No.: EESL/06/2019-20/KUSUM/SWPS/Phase-1/Off
Grid/18072019 Dated:- 18-07-2019

Subject : CN=DEEPAK MITTAL, ST=DELHI, OID.2.5.4.17=110003, OU=CONTRACTS AND PROCUREMENT, O=ENERGY EFFICIENCY SERVICES LIMITED, C=IN
User ID : deepak.mittal
Serial No : F3FA77

SECTION –4 Technical
& SCC

Page 59 of 102



The mismatch shall be calculated as under:

$$\% \text{ Power mismatch in array} = (P_{Max} - P_{Min}) / (P_{Max} + P_{Min}) \times 100$$

P_{Max} = Maximum power among modules in array

P_{Min} = Minimum power among modules in array

10.7 Efficiency of Array

Efficiency of Array = The power output from array / (total area of modules in m^2 X Sun radiation in watts/ m^2)

10.8 Fill Factor of Array

Fill factor of Array = This has to be measured using a PV array tester. This depends on the overall series resistances and shunt resistances of modules in the array.

10.9 Output Voltage of Array

Output Voltage of Array = Sum of voltages of modules in series

In parallel connected module strings, the lowest voltage generating strings will set the voltage.

10.10 Output Current of Array

Output Current of an Array = Sum of currents of the parallel strings in the array.

The output current of a string is controlled by the lowest current generating module.

10.11 Output Power of Array

Output Power of Array = Sum of power of all modules- mismatch loss

This can be measured by PV array tester.



11 EXAMPLES:

11.1 Total per day flow

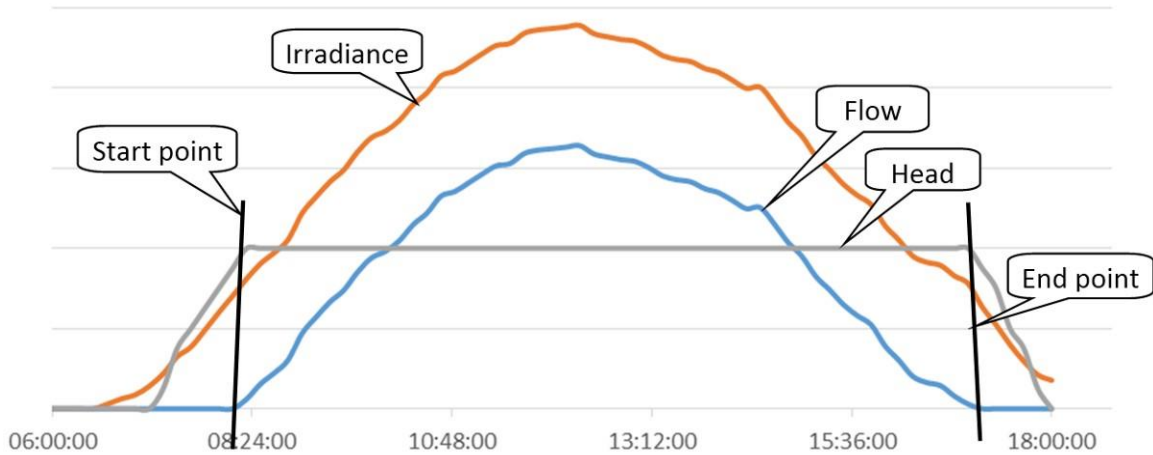

FIGURE 5- TYPICAL GRAPH FOR UNDERSTANDING CALCULATION

If pump achieved constant head at 8:15:30 AM (Start point in figure 5) and in evening pump unable to keep constant desired head at 17:45:30 PM (End point in figure 5).

Flow rate in lps is recorded from 08:15:30 AM to 17:45:30 PM (start point to end point)
If the average lps calculated is 3.55 lps then total flow will be

$$\begin{aligned} \text{Total duration of flow} &= \text{End Time} - \text{Start time} \\ &= 17:45:30 - 8:15:30 \\ &= 9 \text{ h} : 30 \text{ m} : 0 \text{ s} \end{aligned}$$

$$\begin{aligned} \text{Total duration from start to end seconds:} \\ &= (9 \times 3600) + (30 \times 60) + (0 \times 1) = 34200 \text{ seconds} \end{aligned}$$

$$\begin{aligned} \text{Total per day flow in liters} &= \text{Average flow in lps} \times \text{total seconds} \\ &= 3.55 \times 34200 = 121410 \text{ liters} \end{aligned}$$

For realistic test, correct total flow at reference Average Daily Solar Radiation as specified in MNRE specifications.

12 TEST REPORTS

In order to have uniformity, the test reports issued by the Labs shall use common format developed by NISE. The test report shall be issued only in the name of applicant and shall



clearly indicate whether the Solar PV water pumping system qualifies as per MNRE specifications or not along with details. A soft copy of test report shall also be provided to the applicant and shall be made available on web-portal of test lab, which may be accessed by the implementing agencies to verify the authenticity of the report.

13 USE OF OTHER BRAND OF SOLAR MODULES

In case a test lab has tested and issued approval certificate for a particular model of SPV pumping system using a particular brand of SPV Modules, the applicant may use SPV Modules of other brand for the same model of SPV pumping system without going for retesting of SPV pumping system with other brand of SPV Modules provided the test lab certifies that the SPV Module of other brand is atleast of same wattage capacity and its parameters and characteristics are not inferior to the brand of SPV Module with which the model of SPV pumping system was tested and certified by the testing lab. In addition, configuration of solar array i.e. the number of solar modules in series and/or parallel combination will remain unaltered. Further, in each case the SPV module shall follow the quality control order issued by MNRE from time to time. Following criterion shall be followed:

- Solar Array Maximum voltage V_{mpp} with new brand module shall be within $\pm 2\%$ of earlier module.
- Modules Efficiency and Fill Factor shall qualify minimum requirement of MNRE specifications
- Array and module Mismatch shall meet the MNRE specifications.

13 LABS AUTHORISED FOR SOLAR PUMP TESTING

The National Institute of Solar Energy and any other lab accredited by NABL for testing of solar PV water pumping system as per MNRE specifications and testing procedure are authorized to issue approval certificate on successful testing of a solar PV water pumping system.



ANNEX A
(Clause 2)

LIST OF REFERRED STANDARDS

<i>IS NO.</i>	<i>Title</i>
14286 : 2010	Crystalline Silicon Terrestrial Photovoltaic (PV) Modules — Design Qualification and Type Approval
3043:1987	Code of Practice for Earthing
5120:1977	Technical requirements for rotodynamic special purpose pumps (First revision)
11346:2003	Tests for Agricultural and Water Supply Pumps - Code of Acceptance
6603:2001	Stainless Steel Bars and Flats
6911:2017	Stainless steel plate, sheet and strip Stainless steel plate, sheet and strip
7538:1996	Three-phase squirrel cage induction motors for centrifugal pumps for agricultural applications
8034:2002	Submersible pump sets - Specification (second revision)
9079:2002	Electric monoset pumps for clear, cold water for agricultural and water supply purposes - Specification (second revision)
9283:2013	Motors for submersible pump sets
11346:2002	Code of acceptance tests for agricultural and water supply pumps (first revision)
14220:1994	Open well submersible pump sets - Specification
14582:1998	Single-phase small AC electric motors for centrifugal pumps for agricultural applications
ISO 9905:1994	Technical specifications for centrifugal pumps -- Class I
IEC 60068-2-6:2007	Environmental testing – Part 2-6: Tests – Test Fc: Vibration (sinusoidal)
IEC 60068-2-30:2005	Environmental testing – Part 2-30: Tests – Test Db: Damp heat, cyclic (12 + 12h cycle)
IEC 60146-1-1:2009	Semiconductor converters - General requirements and line commutated converters - Part 1-1: Specification of basic requirements
IEC 60364-4-41:2005	Low-voltage electrical installations - Part 4-41: Protection for safety - Protection against electric shock
IEC 60364-7-712:2017	Low voltage electrical installations - Part 7-712: Requirements for special installations or locations - Solar photovoltaic (PV) power supply systems
IEC 60529:1989	Degrees of protection provided by enclosures (IP Code)
IEC 60947-1:2007	Low-voltage switchgear and control gear - Part 1: General rules
IEC 61000-6-2:2016	Electromagnetic compatibility (EMC) - Part 6-2: Generic standards - Immunity standard for industrial environments

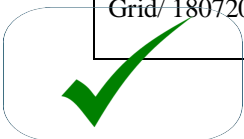

IEC 61000-6-3:2006	Electromagnetic compatibility (EMC) - Part 6-3: Generic standards - Emission standard for residential, commercial and light-industrial environments
IS/IEC 61683 :1999	Photovoltaic Systems — Power Conditioners — Procedure for Measuring Efficiency
IS/IEC 61730-1 : 2004	Photovoltaic (Photo Voltaic (PV)) Module Safety Qualification Part 1 Requirements for Construction
IS/IEC 61730-2 : 2004	Photovoltaic (Photo Voltaic (PV)) Module Safety Qualification Part 2 Requirements for Testing
IEC 61800-3:2017	Adjustable speed electrical power drive systems - Part 3: EMC requirements and specific test methods
IEC 62109-1:2010	Safety of power converters for use in photovoltaic power systems - Part 1: General requirements
IEC 62305-3:2010	Protection against lightning - Part 3: Physical damage to structures and life hazard
IEC 62458:2010	Sound system equipment – Electro-acoustical transducers - Measurement of large signal parameters



Universal Solar Pump Controller (USPC) Specifications for Stand-alone applications

1. Preamble:

The Controller for Solar PV pumping system is the heart and brain of the system. The Solar PV pumping system deployed at huge cost to the farmer and the exchequer for the Government is currently utilised only for half of the days in a year (around 150 days per year) on an average. In order to optimally utilize the solar photovoltaic system that generates the electricity throughout the year during sunshine hours, the controller supplied for installation of solar pumping system should be able to perform several other tasks for agricultural and other needs of a farmer. This will increase the productivity of agriculture sector and income of farmer. With the use of USPC the solar system could be used effectively throughout the year.

2. Technical Specification for Stand Alone Application

The USPC with SPV modules and structure can be used for agrarian applications such as water pumping, apple grading and polishing system, wheat (grain) flour grinding machine / aata chakki, cutter/chaff, deep-fridger / cold storage, blower fan for cleaning of grains, heating loads and any other standard voltage (400/415V) three phase motor/equipment of capacity not more than the capacity of Solar PV pumping system. The USPC operation schematic diagram is shown in Fig. 1. Further, the applications are not limited upto the few shown in the figure.

- I. Following table gives specifications of electrical supply from USPC for motors other than the solar pumps. For operating the pump the USPC must follow the MNRE specifications for SPV pumping systems.

Sr No.	Description	Desired requirement
1	Motor Supply Phases	Three phase R-Y-B
2	Rated motor frequency	48-50Hz
3	Frequency operation	0 to 52Hz
4	Rated motor voltage	415V \pm 5%
5	Desired motor operation	Constant V by F or constant motor flux control



II. Proposed electrical properties of USPC when operating motors other than motor-pump set:

Sr No.	Description	Desired requirement
1	Characteristic of voltages	Pure sinusoidal or Filtered AC output voltage at motor terminal. No PWM pulses allowed at the motor terminal, as it generates pronounced voltage spikes. The USPC output is intended to use for the traditional induction motors based applications which are design for sinusoidal grid supply.
2	THD of motor terminal voltages	Below 3%
3	THD of motor current (in case of balance/linear motor)	Below 5%
4	Balance supply	Three phases should be balanced and no negative sequence components to be allowed
5	Voltage spikes	Recurring or non-recurring voltage spikes more than 620V (peak of 440V AC supply) is not allowed between any two terminals
6	Alarms and Protections	Output voltage low, Output frequency low/high, Low irradiance/PV power, Current overload, Peak Torque overload

III. Controller should be able to run SPV pumping system as per MNRE specifications as well as any other type of motor of suitable rating, subject to the load characteristics of the equipment in which the motor is used is any of the following:

- a) Constant torque loads
- b) Constant power loads
- c) Quadratic loads
- d) Impact loads
- e) Hydraulic loads

Subject to the maximum torque being not more than 150% of the rated torque of the motor.

IV. To ensure energy efficiency of solar PV system and to maintain reliability of PV installation against aging effect, module mismatch with time, partial shading, etc. , the desired USPC properties and configuration should be as follows:

- (a) Static MPPT efficiency of USPC should be equal or more than 98% during operation of 10 to 100% of rated STC PV power, and average MPPT tracking efficiency in the dynamic condition should be greater than 97 % with hot and cold profiles when feeding the water pumping, hydraulic or heating loads, so as to maintain MPPT irrespective of variation in solar energy or irradiance. `
- (b) USPC efficiency should be as follows for the operation at 80% rated STC power of the PV array:



Sr No.	SPV pumping system capacity	Controller power efficiency should be more than or equal to
1	3 HP	93.00%
2	5 HP	93.00%
3	7.5 HP	94.00%
4	10 HP	94.50%
5	15 HP	94.50%

- (c) Considering voltage variation over the year due to variation in temperature, irradiance and effect due to ageing, environmental damages to PV panels with time, USPC should have MPPT channels as an integral part of system (or externally connected part) with wide range of input PV voltage for MPPT tracking of the PV panels. Input voltage range variation should be tested as per manufacturer declaration (min, nominal or 90% of the maximum) or if no declaration is made than at least it should be tested as per the table given below.

Sr No.	Motor Pump set capacity	Input voltage range		
		Minimum	Nominal	Maximum
1	3 HP	(Vnominal-50)	Nominal	(Vnominal+50)
2	5 HP	(Vnominal-70)		(Vnominal+70)
3	7.5 HP	(Vnominal-70)		(Vnominal+70)
4	10 HP	(Vnominal-100)		(Vnominal+100)
5	15 HP	(Vnominal-100)		(Vnominal+100)

- V. There should be Mode selection located on control panel of the USPC along with display and user should be able to select either to run motor-pump set of any other application. The software/firmware required to operate these applications must get automatically loaded when an appropriate position of the switch is engaged.
- VI. USPC must have at least four numbers of three phase output cables to feed power to the applications. The output power cable for specific application should get selected automatically upon selection of applications via keypad or via mobile or via remote control connectivity. The manual selector switch should not be used at the output to manage different loads. This is to ensure the hassle free operation of applications by farmer with adequate safety.



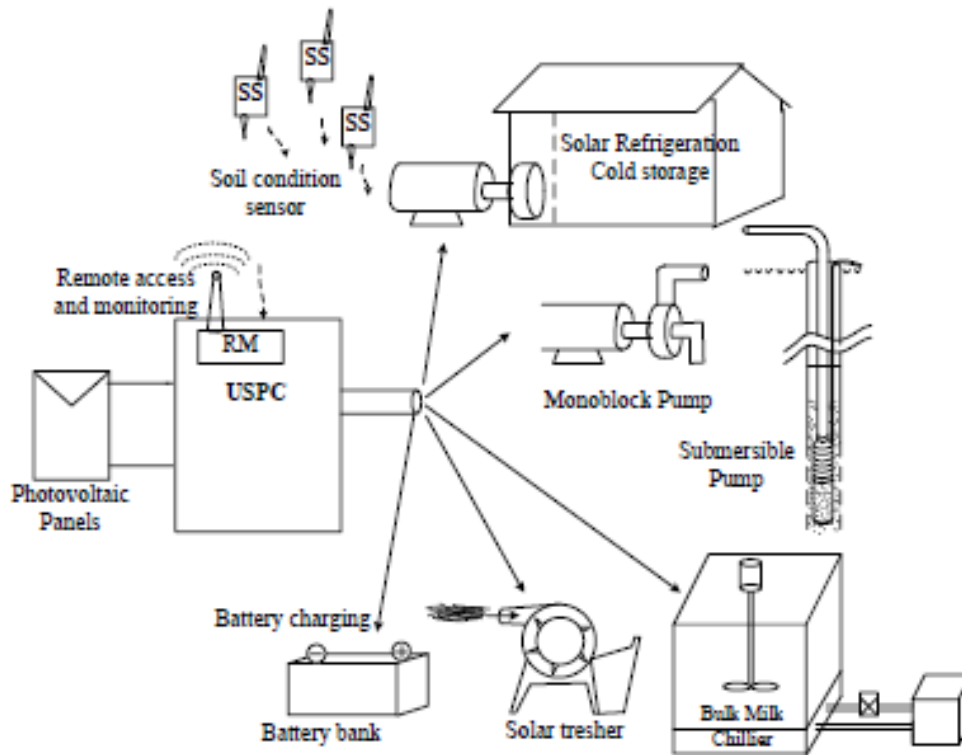

Fig. 1. USPC operation schematic diagram.

VII. USPC based Solar system must be equipped with Remote monitoring and remote fault identification:

- (a) Remote monitoring features should be integral part of solar pump controller and should provide time wise remote monitoring of PV voltage, PV Power, Water output, head, when used in solar pump mode. When operated in farm equipment mode, it should show, PV voltage, PV power, motor voltage, motor current and motor frequency.
- (b) Cumulative energy generation from PV panels for a month, year and 5 years should be provided.
- (c) Remote monitor should show current status of system like On, Off and fault.
- (d) Software associated with remote monitoring should also provide location of SPV pumping system.
- (e) Controller should have support of sufficient Internal memory/ SD card / memory card to support remote monitoring in case of network failure.

USPC must have IP65 protection or must be housed in a cabinet having at least IP65 protection.

Testing Procedure for Universal Solar Pump Controller (USPC)

USPC must be tested in two principle modes:

1. As an offgrid solar pump controller: the testing should be as per MNRE specifications and Test procedure.
2. As a controller to operate motorized farm equipment: The testing should be as described below.

To test the USPC in the second mode the test centres must have standard actual mode suitable for 4 loading modes. The input to the USPC must be from a solar PV simulator using the hot and cold profiles issued by MNRE. Following tests may be performed on USPC driving the agrarian load like Atta Chakki, Chaff Cutter and Deep Freezer under test. The USPC must be able to operate these motors of the attached agrarian load, so that they deliver the rated torque and are able to also operate till 150% of the rated torque for 30 seconds.

S.No	Test Performed	Expected result	Test Lab Observation	Remarks
1	Application description on screen and selection of applications	LCD screen provided on controller need to shows various applications which can be selected by keypad using up-down and enter key		
3	Mode operation of applications (Automatic: through keypad or remote / Manual: control switches)	Universal Solar Agriculture controller should come with multiple outputs which can be permanently connected to the application by selecting appropriate options for example following applications should automatically started by USPC by appropriate mean such as keypad or remote for selection. (i) Water Pumping (ii) Chaff Cutter (iii) Deep fridge/ Cold Storage (iv) Atta Chakki Manual changeover is not allowed.		
4	Application Specific output (Application specific software)	USPC should have inbuilt individual application specific software to run the agrarian applications other than pumps and output of the controller should be suitable for above mentioned applications	-	



5	Input PV voltage range Minimum – Voc at STC Nominal – Voc at STC Maximum – Voc at STC			
6	USPC Efficiency measurement in Hot and cold profile should be measured as per BS EN 50530/IEC 62891	Efficiency of the UPSC at minimum..... VOC		
		Load %	Charge controller eff (%)	Power tracking Efficiency (%)
		10		
		25		
		50		
		75		
		100		
		Efficiency of the UPSC at Nominal VOC		
		10		
		25		
		50		
		75		
		100		
		Efficiency of the UPSC at 90 % of Max VOC		
		10		
		25		
		50		
		75		
		100		
		Dynamic MPPT Efficiency		
		Hot Profile		
		Cold Profile		
7	Ripple and distortion at output on full load	Should below 5 % after 25 % loading condition		
8	Measurement of Output voltage waveform	Three phase output with up to 440 V rms pure Sine Wave to be measured at least 4 times between 300W/m2 irradiance and maximum irradiance as per the irradiance profile.	CF value should be provided by lab for voltage and current	

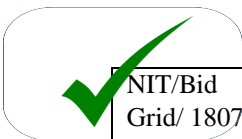

Signature :-
Subject : CN=DEEPAK MITTAL, ST=DELHI, OID.2.5.4.17=110003, OU=CONTRACTS AN
PROCUREMENT, O=ENERGY EFFICIENCY SERVICES LIMITED, C=IN
User ID : deepak.mittal
Serial No : F3FA77

9	Operation at different output from array with all four load types (Array wattage as per MNRE model:	Above Watt DC output Should not stop functioning at any load condition. Observation should be recorded.	Power value should be recorded by the lab with all agrarian load	Motor current should be recorded (for torque behavior) It must be almost constant
	Example 4800 Wp array) At 40% Power At 50% Power At 75% Power At 100% Power		supported by USPC	irrespective of available DC power from array (motor running condition). This is for Impact loading condition (such as Chaff cutter) current variation need to be recorded by laboratory.
10	Operation at different output from array with all four load types (Array wattage as MNRE model: Example 4800 Wp array) At 10 % Power At 25 % Power At 30 % Power	USPC need to run all the agrarian load in variable frequency at the lower irradiance value The load may be increased beyond 150% of rated torque to determine at what level the motor is stalling and stopping and it must trigger ‘torque overload’ alert. If it goes beyond 150% of the motor rated torque the USPC must trip indicating an ‘overload tripping’.	Motor current should be recorded (for torque behavior) as it is a function of V/F ratio controlled by USPC	
11	Total circuit protection observation	<ul style="list-style-type: none"> · Soft Startup, · low radiation protection, · overload protection, · Open circuit protection · Reverse polarity protection 		

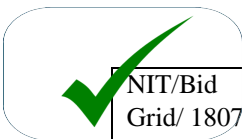

Expected output of individual applications must be specify as per their power rating and SPV capacity, such as:

1. kg/hour grinding of atta chakki, and granularity.
2. Volumetric Iceing of cold storage in x hours.
3. Output in terms of kg/hours for a specific capacity grass-cutter.
4. Output must be quantify in terms of rate of volume or weight as above for any other applications.

Following test labs may also conduct testing of USPC as per procedure prescribed above and issue testing certificates:

1. Central Power Research Institute (CPRI)
2. UL India Pvt. Ltd.
3. National Institute of Solar Energy (NISE)

Signature :-
Subject : CN=DEEPAK MITTAL, ST=DELHI, OID.2.5.4.17=110003, OU=CONTRACTS AN
PROCUREMENT, O=ENERGY EFFICIENCY SERVICES LIMITED, C=IN
User ID : deepak.mittal
Serial No : F3FA77

 NIT/Bid Document No.: EESL/06/2019-20/KUSUM/SWPS/Phase-1/Off
Grid/ 18072019 Dated:- 18-07-2019

SECTION –4 Technical
& SCC

Page 72 of 102

QUALIFYING REQUIREMENT (QR):

In addition to the satisfactory fulfillment of requirements stipulated under section ITB, the following shall also apply:

S No. (A)	Criteria (B)	Documents to be submitted (C)	Particulars in brief of the Documents submitted by Bidder on Covering Letter (D)
1	The bidder should be a firm registered/ incorporated under Companies Act, 1956 or Companies Act, 2013/ and further amendment (s), or a registered partnership firm (registered under section 59 of the Partnership Act, 1932) or a limited liability partnership (under the Limited Liability Partnership Act, 2002).	Photocopy of Certificate of Incorporation issued by the Registrar of Companies/firms/LLP	1.Company Incorporation Certificate No. _ Date: __
2.	The bidder should be, either of the following: i) Solar PV Module Manufacturer Or ii) Solar Pump Manufacturer (No Consortium is allowed in this tender) Past experience required for the bidders from minimum last three financial years is as per Table 1 below	Work order copies/ LoA's/Completion Certificates from registered central/state/PSU (Public Sector Undertaking)/Distribution Company (DISCOM). AND Memorandum of Association, Article of Association needs to be attached along with the bid. The bidder should also highlight the relevant provision/ article number which highlights the objects relating to the business fields mentioned in the previous column. AND Copy of Factory License under the Indian Factories Act, 1948 and GST registration Certificate, supporting the fact of the bidder being engaged in the business field mentioned in column B.	Tabular details comprising of Order No.; Order Date; Client's Name; Description of Project; Supply/Completion Period (with from-/to-dates); Ref. No. & Date of Material Receipt Certificates/ PO/Work Completion Certificates



S No. (A)	Criteria (B)	Documents to be submitted (C)	Particulars in brief of the Documents submitted by Bidder on Covering Letter (D)
3	<p>Bidder should have valid Test Certificate for the tendered Solar Water Pump System (complete system) from following test labs only:</p> <ol style="list-style-type: none"> 1. Central Power Research Institute (CPRI) 2. UL India Pvt. Ltd. 3. National Institute of Solar Energy (NISE) <p>In case of non-availability of Original test certificate, Bidder shall submit the acknowledge Receipt/certificates at the time of bid submission from any of the above three test labs. But in that case bidder should submit the test report/certificate before SNA places the LoA. On submission of the original test certificate/report only, the LOA will be issued to successful bidders.</p> <p>In case Bidder fails to submit original test certificate within 30 days of SNA intimation or mutually agreed between SNA and successful bidder, his bid will stand cancelled, without any prior intimation.</p>	<p>Original test certificates need to be submitted at the time of submission of bid. (Tested parts in the report must be used for the entire project without any changes.)</p>	<p>N.A.</p>



4	Bidders should have Average Annual Turnover (ATO) as per Table 2 below for immediately preceding last three financial years 2016-2017, 2017-2018, and 2018-2019.	<p>Duly authorized copy of audited annual report/Balance Sheet for last three years is to be submitted by respondent along with CA certificate.</p> <p>The bidder shall submit last 3 years' audited financial statements i.e. FY 2016-17, FY 2017-18 & FY2018-19. Incase bidder is not able to provide the Audited Financial Statements for FY 2018-19 the unaudited financial statements duly signed by management to be provided Along With Statutory Auditor certificate verifying the Turnover , PAT & Net Worth in the prescribed format. Wherever the bidder is unable to furnish the audited financial statements or unaudited financial statements duly signed by management along With Statutory Auditor certificate for the FY 2018-19 , the 3 consecutive years to be considered for evaluation will be FY 2015-16, FY 2016-17 & FY 2017-18.</p> <p>Turnover means operating income. Profitability means: Profit after tax</p>	M/s 2016-17: 2017-18: 2018-19:
5	The bidder should be profitable in last financial year i.e. 2018-19 and any of the one of the financial year out of 2016-17 or 2017-18.	<p>Duly authorized copy of audited annual report/Balance Sheet for last three years is to be submitted by respondent along with CA certificate.</p> <p>The bidder shall submit last 3 years' audited financial statements i.e. FY 2016-17, FY 2017-18 & FY2018-19. Incase bidder is not able to provide the Audited Financial Statements for FY 2018-19 the unaudited financial statements duly signed by management to be provided Along With Statutory Auditor certificate verifying the Turnover , PAT & Net Worth in the prescribed format. Wherever the bidder is unable to furnish the audited financial statements or unaudited financial statements duly signed by management along With Statutory Auditor certificate for the FY 2018-19 , the 3 consecutive years to be considered for evaluation will be FY 2015-16, FY 2016-17 & FY 2017-18.</p> <p>Turnover means operating income. Profitability means: Profit after tax</p>	M/s 2016-17: 2017-18: 2018-19:



6	Bidder needs to submit documentary evidence that components should be indigenously manufactured for the supplied systems.	<p>Declaration of sourcing/manufacturing of components, clearly specifying as being indigenously manufactured. Details of the manufacturing/sourcing firm/facility, including Company Profile, to be provided accordingly.</p> <p>AND</p> <p>The bidder should submit the list and pictures of the manufacturing and testing facilities and submit an undertaking that if the details provided by the bidders are in deviation with the provision of the scheme, it will call for disqualification. If considered necessary, a team of SNA officials may visit the facilities of the bidders for verification</p> <p>Along with above documents required to be annexed to the invoice (at the time of payment in case of successful bidder), copies of the Excise invoice(s) of the manufacturing unit(s) of the Solar PV Module, Pumps etc. shall also be annexed to the invoice for claiming payment.</p>	N.A
---	---	---	-----



7	<p>The Net worth of bidder as on the last day of preceding financial year (2018-19) shall not be less than 100% of the paid-up share capital.</p>	<p>Duly authorized copy of audited annual report/Balance Sheet for last three years is to be submitted by respondent along with CA certificate.</p> <p>The bidder shall submit last 3 years' audited financial statements i.e. FY 2016-17, FY 2017-18 & FY2018-19. In case bidder is not able to provide the Audited Financial Statements for FY 2018-19 the unaudited financial statements duly signed by management to be provided Along With Statutory Auditor certificate verifying the Turnover , PAT & Net Worth in the prescribed format.</p> <p>Wherever the bidder is unable to furnish the audited financial statements or unaudited financial statements duly signed by management along With Statutory Auditor certificate for the FY 2018-19 , the 3 consecutive years to be considered for evaluation will be FY 2015-16, FY 2016-17 & FY 2017-18.</p> <p>Turnover means operating income. Profitability means: Profit after tax</p>	<p>Individual Net Worth Details</p> <p>M/s</p> <p>2016-17: 2017-18: 2018-19:</p>
---	---	--	--



Table 1 (Past Experience):

Cluster	States	For Solar Pumps (No. of Solar Pumps installed/supplied)	For Solar PV modules installed/supplied (Experience in MWp)
1	Andhra Pradesh, Telangana	1,560	7.80
2	Chhattisgarh, Madhya Pradesh	1,656	8.28
3	Rajasthan	1,500	7.50
4	Tamil Nadu	1,500	7.50
5	Haryana, Punjab	1,170	5.85
6	Bihar, West Bengal, Odisha	342	1.71
7	Gujarat, Maharashtra	780	3.90
8	Jharkhand, Uttar Pradesh	1,500	7.50
9	Himachal Pradesh, Jammu & Kashmir, Uttarakhand	180	0.90
10	Meghalaya, Mizoram, Tripura, Assam	234	1.17

NOTE 1: The combine past experience for all clusters applied by the bidder shall be consider for evaluation. For example: If bidder quoted for Cluster 1 and Cluster 2, the past experience for supply/installed of Solar Pumps should be 3,216 (1,560 + 1,656), past experience for Solar PV Modules should be 16.08 Mega Watt-peak (7.8 + 8.28).

NIT/Bid Document No.: EESL/06/2019-20/KUSUM/SWPS/Phase-1/Off Grid/ 18072019 Dated:- 18-07-2019	SECTION –4 Technical & SCC	Page 78 of 102
---	-------------------------------	----------------

Signature :-
Subject : CN=DEEPAK MITTAL, ST=DELHI, OID.2.5.4.17=110003, OU=CONTRACTS AN
PROCUREMENT, O=ENERGY EFFICIENCY SERVICES LIMITED, C=IN
User ID : deepak.mittal
Serial No : F3FA77



Table 2 (Annual Turn Over Requirement):

Cluster	States	Average Annual Turnover in INR Crores
1	Andhra Pradesh, Telangana	47.58
2	Chhattisgarh, Madhya Pradesh	50.51
3	Rajasthan	45.75
4	Tamil Nadu	45.75
5	Haryana, Punjab	35.69
6	Bihar, West Bengal, Odisha	10.43
7	Gujarat, Maharashtra	23.79
8	Jharkhand, Uttar Pradesh	45.75
9	Himachal Pradesh, Jammu & Kashmir, Uttarakhand	6.04
10	Meghalaya, Mizoram, Tripura, Assam	7.85

NOTE 2: The combine ATO for all the states applied by the bidder shall be consider for evaluation. For example: If bidder has quoted for Cluster 1 and Cluster 2, the ATO of the bidder should be INR 98.09 Crs (INR 47.58 Cr + INR 50.51 Cr).

For Start-up firms as per Gazette Notifications dated: 17- Feb-2016, G.S.R. 180 (E) and MSMEs relaxation will be given in this tender as per Clause No. 2.4 of Section 2 of this tender.

- ¶ In case a bidder does not satisfy the financial criteria, the holding company would be required to meet the stipulated turn over and profitability requirements, provided that the net worth of such holding company as on the last day of the preceding financial year is at least equal to or more than the paid-up share capital of the holding company. In such an event, the bidder would be required to furnish along with its bid, a letter of Undertaking from the holding company, supported by the Board Resolution, as per the format enclosed in the bid documents, pledging unconditional and irrevocable financial support for the execution of the Contract by the bidders in case of award.
- ¶ In case the Bidder meets the requirement of Net worth based on the strength of its Subsidiary(ies) and/or Holding Company and/or Subsidiaries of its Holding Companies

NIT/Bid Document No.: EESL/06/2019-20/KUSUM/SWPS/Phase-1/Off
Grid/ 18072019 Dated:- 18-07-2019

SECTION –4 Technical
& SCC

Page 79 of 102

Signature :
Subject : CN=DEEPAK MITTAL, ST=DELHI, OID.2.5.4.17=110003, OU=CONTRACTS AND
PROCUREMENT, O=ENERGY EFFICIENCY SERVICES LIMITED, C=IN
User ID : deepak.mittal
Serial No : F3FA77



wherever applicable, the Net worth of the Bidder and its Subsidiary(ies) and/or Holding Company and/or Subsidiary(ies) of the Holding Company, in combined manner should not be less than 100% of their total paid up share capital. However individually, their Net worth should not be less than 75% of their respective paid up share capitals.

Notes:

- ¶ Bidder is allowed to participate in consortium with NSIC. In case of Consortium of NSIC, the lead members & consortium partners shall not separately participate as independent bidder or as members of any other consortium in this bidding process. All bids in contravention of this shall be rejected.
- ¶ In case of participation as NSIC, it is clarified as consortium of maximum two members are allowed including NSIC as lead member. In one tender, only bid from one NSIC Consortium will be accepted. No other consortium is allowed apart from NSIC
- ¶ “Holding Company “and “Subsidiary “shall have the meaning ascribed to them as per Companies Act, 1956 or, in vogue.
- ¶ In case bidder has been found to be defaulting on the delivery period (in each LoA issued) as per assessment (supply, installation etc.) will be liable to be rejected. Bidder have to provide the quantity (Nos. & Percentage) supplied and installed against each LoA awarded by SNA at the date of submission of bid.
- ¶ Net worth means the sum total of the paid up share capital and free reserves. Free reserve means all reserves credited out of the profits and share premium account but does not include reserves credited out of the revaluation of the assets, write back of depreciation provision and amalgamation. Further any debit balance of Profit and Loss account and miscellaneous expenses to the extent not adjusted or written off, if any, shall be reduced from reserves and surplus.
- ¶ Other income shall not be considered for arriving at annual turnover.
- ¶ The supporting documents in support of above Qualification Requirement should be submitted along with tender document, otherwise Techno-commercial offer submitted by the bidder is liable to be considered as non-responsive.

All the required documents must be properly annexed and submitted as mentioned above with necessary details in brief in column D

NIT/Bid Document No.: EESL/06/2019-20/KUSUM/SWPS/Phase-1/Off
Grid/ 18072019 Dated:- 18-07-2019

SECTION –4 Technical
& SCC

Page 80 of 102

Signature :-
Subject : CN=DEEPAK MITTAL, ST=DELHI, OID.2.5.4.17=110003, OU=CONTRACTS AND
PROCUREMENT, O=ENERGY EFFICIENCY SERVICES LIMITED, C=IN
User ID : deepak.mittal
Serial No : F3FA77



Format 1**Information on Average Annual Turnover**

{To be printed on the Letterhead of the bidder including full postal address, telephone, faxes and e-mail address}

Annual Turnover Data for the Last 3 Years

Year	Net Worth(in INR)	Annual Turnover (in INR)
2018-19		
2017-18		
2016-17		
Annual Average		

{This format should be certified by the practicing CA's of the Bidder}

Format 2**Information on Profitability**

{To be printed on the Letterhead of the bidder including full postal address, telephone, faxes and e-mail address}

Profit before Tax Data for the last 3 years

Year	Amount (in INR)
2018-19	
2017-18	
2016-17	

{This format should be certified by the practicing CA of the Bidder}



Annexure-V

SPECIFIC CONFIRMATION BY BIDDER	
Note: Please submit the table below duly filled, signed and stamped along with Techno-Commercial Bid.	
Description	Remarks
In case more than one bidder gets qualified based on the Techno-commercial Bid, then the bidder quoting the lowest total price for SPWPS defined in price-bid table will qualify as the successful bidder.	Agreed.
Bidders should have financial and technical capabilities to execute the Scope of Work as specified in the RFP.	Vendor to give their acceptance along with supporting documents
Offer of Warranty less than 5 YEARS from the date of delivery of respective consignment will not be accepted and bidder shall be disqualified.	Agreed.
Payment Terms—as per SCC Clause No. 1.0.	Agreed.
Test Reports of SPWPS from NABL Certified Lab are to be submitted for all non-life tests.	Agreed.
For the purpose of this Tender, the successful bidder needs to provide name, address, mobile no., email addresses, designations of at least 3 Senior Nodal Officers (Regular Employees of their organization), nominated by their top management, who are reachable through any means of modern communication and who shall be accountable to deliver the product and associated services to SNA as per the tender.	To be indicated. To be enclosed separately
Any entity which has been barred by the Central/State Government or PSUs (Public Sector Undertakings), from participating in any bid, and the bar subsists as on the Bid Due date, would not be eligible to submit a Bid. Necessary declaration to this effect has to be given by the bidder as per format in the tender form.	Vendor to give a declaration on its letterhead pad.
Bidder should have an existing network or has to set-up a local service network in the Project Areas to support post-delivery maintenance activities. The Successful Bidder has to further support the project by opening office in the state for delivery with one Project Manager and one Project Engineer dedicated full-time to support supply and post-distribution warranty commitments.	Details of service support network or plans for deployment of such network in project area to be provided. To be enclosed separately as Annexure.
EESL/SNA reserves the right to ask other qualified bidders to match the evaluated price of L-1 Bidder. EESL/SNA reserves the right to offer up-to 25 % of L-1 quantity to NSIC Consortium, provided they meet all tender terms and conditions (except where they are exempted by Government Order) and also comply with the L-1 rate, quality, supply schedules of tender for bidders.	Agreed.
EESL/SNA reserves the right for quantity variation up to +/- 20%. Further EESL/SNA reserves the right to place a repeat order in case of urgency for part quantity in the Letter of Award for similar work on same prices, terms and conditions.	Agreed.
EESL/SNA shall give preference domestically manufacturers as per Policy Notification no. F.No.33 (3)/2013-IPHW dated 22.05.14 of Department of Electronics & Information Technology, provided they meet all terms and conditions of tender on price, quality, supply schedule, branding, etc.	Agreed.
It will be the sole discretion of EESL/SNA to award the quantity irrespective of the quantity mentioned by the bidder and the band provided.	Agreed.
Detailed Test certificate for SPWPS being offered meets Technical Specifications as per RFP.	Agreed.
Sample copy of batch test report specifying all the required tests will be reported with each consignment.	Agreed.
Undertaking by authorized signatory that all Central/State taxes, duties, levies, etc. shall be complied with by the supplier.	Undertaking to be provided. To be enclosed separately as Annexure.
Declaration that Bidder has not been barred/ banned/ black-listed by Central/ State Government or PSUs (Public Sector Undertakings).	Agreed.
Price Validity till 365 days from the date of Price Bid opening	Agreed

NIT/Bid Document No.: EESL/06/2019-20/KUSUM/SWPS/Phase-1/Off Grid/ 18072019 Dated:- 18-07-2019

SECTION –4 Technical & SCC

Page 82 of 102

Signature :
 Subject : CN=DEEPAK MITTAL, ST=DELHI, OID.2.5.4.17=110003, OU=CONTRACTS AND PROCUREMENT, O=ENERGY EFFICIENCY SERVICES LIMITED, C=IN
 User ID : deepak.mittal
 Serial No : F3FA77



SPECIAL CONDITIONS OF CONTRACT

SPECIAL CONDITIONS WILL PREVAIL UPON THE INSTRUCTION TO BIDDERS AND OTHER TERMS AND CONDITIONS

1. TERMS OF PAYMENT:

Stage I: - 90% of the order value and 100% applicable taxes of the order value i.e. on every 1000 nos. of SPWPS delivered at site based on:

- Submission of detailed work plan (Project Execution plan with timeline for the lot supplied duly approved by SNA's representative;
- Submission of evidence in hard copy regarding completion of supply of 1000 Nos. of SPWPS in good condition at site, duly verified and acknowledged by EIC, SNA (LR copies). The LR copies should be duly certified by SNA's site representative.
- All the relevant Warranty and quality (performance test reports) of the lot to be submitted.
- Signing of contract agreement between SNA and successful bidder.
- Submission of Contract Performance Guarantee (CPG) as per relevant CPG clause to SNA's
- Submission of original supply Invoices/Bills duly verified/certified by EIC, SNA.
- Submission of Product Clearance Report as per tender conditions duly certified by representative of SNA.

Stage II: - 10% of the order value i.e. on installation of every 1000 nos. of SPWPS based on:

- Submission of handing over certificates of solar photovoltaic water pumping system signed and/or stamped by VDO/BDO/Sarpanch/Panchayat Secretary/AE or JE of municipal cooperation duly certified by SNA's representative;
- Submission of installation report as per prescribed format of SNA.
- Submission of report supported with labelled photograph on completion of village community training, awareness/ sensitization, capacity building measures undertaken and development of entrepreneurship etc. in each village with relevant photographs and videos;
- Operation and Maintenance manual to be provided to each beneficiaries and should submit the same with SNA.

In case total supply of SPWPS is less than 1000 no.s then the actual quantity of supply shall be considered for release of payment.

In case last lot of supply of SPWPS is less than 1000 no.s then the actual quantity of supply in last lot shall be considered for release of payment.

Note: -

- SNA has the right to seek any additional documents / information / certification it deems fit prior to the release of any payment.
- Weekly as well as consolidated quarterly reports are expected to be submitted by the bidder.
- Payment will be made to the bidder within 30 Days after submission of Invoice complete in all respect i.e. with all the required documents and compliance of relevant terms & conditions of LOA duly accepted & certified by EIC, SNA

If the invoice is incomplete in any respect or if there is any non-compliance with relevant Terms &

NIT/Bid Document No.: EESL/06/2019-20/KUSUM/SWPS/Phase-1/Off
Grid/ 18072019 Dated:- 18-07-2019

SECTION -4 Technical
& SCC

Page 83 of 102

Signature :-
Subject : CN=DEEPAK MITTAL, ST=DELHI, OID.2.5.4.17=110003, OU=CONTRACTS AND
PROCUREMENT, O=ENERGY EFFICIENCY SERVICES LIMITED, C=IN
User ID : deepak.mittal
Serial No : F3FA77



Conditions of LOA, payment due date shall start from the date of submission of all necessary documents provided relevant terms & conditions of LOA have been fulfilled.

PROCESS FOR RAISING INVOICE/BILL: -

- The successful Bidder's request (s) for release of payment shall be made to the Engineer-In-Charge in writing, upon fulfillment of required obligations stipulated in the contract.
- The successful Bidder shall submit the invoice in triplicate showing description, quantity, Unit rate and total amount with all supporting documents as per terms of the Contract. After due verification by Engineer-In-Charge, SNA shall process the verified Bill (s)/Invoice (s) for release of payment. In case successful Bidder fails to submit the Invoice/Bill with all the required documents, SNA reserves the right to hold the payment against such Bills/Invoices.
- The successful Bidder shall be responsible for submitting all the requisite documents for processing the Bill (s)/Invoice (s). The successful Bidder shall submit the Bills/Invoices for the work executed showing separately, GST and any other statutory levies in the Bill (s)/Invoice (s).

Note: SNA has the right to seek any additional documents / information / certification it deems fit prior to be release of any installment.

2. PRE-BID CONFERENCE:

The official representative of the Bidders may attend the pre-bid conference to be held as schedule defined in Section-1 at the following address:

Scope Convention Centre
SCOPE Complex, Lodhi Road, New Delhi-110003

- The purpose of the meeting will be to clarify any issues regarding the bid process.
- Record notes of the meeting including the text of the questions raised and responses given will be transmitted to all the bidders who were present at the meeting and will also be put on the web-site. The clarifications that could not be furnished during pre-bid conference will be separately communicated to all the purchasers of the RFP.
- Non-attendance at the pre-bid meeting will not be a cause for rejection of a Bidder.
- Based on the discussion in pre bid meeting, EESL/SNA reserved the right for modification in RFP.
- Bidder(s) are requested to send the queries 3 days in advance from the date of pre bid to the contact points mentioned in Section 1 in the following format:

Name of Tender	
Tender No.	
Tender ID	



Bid Opening Date				
Bidder's Name				
Contact person from Bidder with address, e-mail and Contact No.				
Sr. No.	Section No.	Description as Per RFP	Queries/ Clarification of the bidder	Remarks
	Page No.			
	Para No/ Clause No.			
1.	Section No.			
	Page No.			
	Para No/ Clause No.			
2.	Section No.			
	Page No.			
	Para No/ Clause No.			
3.	Section No.			
	Page No.			
	Para No/ Clause No.			

3. Price Basis: To be quoted as Firm at FOR Destination Basis.
4. Warranty and Maintenance: As per Scope of work.
5. EESL/SNA reserves the right for quantity variation up to +/-20% of total awarded work
6. Successful bidder, on whom letter of award is placed, is to ensure all safety guidelines, rules and regulations, labor laws etc. Successful bidder indemnifies SNA for any accident, injury met by its labour, employee or any other person working for him. Any compensation sought by its labour, employee or any other person working for him shall be paid by successful bidder as per settlement solely. SNA has no role to play in this matter.
7. Successful bidder is to comply, and to procure that its sub-contractors (if any) comply, with international standards for the protection of the environment and labor laws, including the fundamental conventions of the International Labor Organization and the international environmental conventions, in accordance with the applicable laws and regulations of India.
8. Successful bidder is to submit interchangeability certificate for its product supplied for replacement during warranty and maintenance period and even when it is purchased from open market. In case due to change in technology, the supplied product is not available during warranty/ maintenance period than the improved version of product can be used in warranty/ maintenance period with same or improved technical parameters or the combination thereof after written communication of Engineer in Charge of SNA at same



Cost & terms and conditions. Successful Bidder, on whom letter of award has been placed, has also to confirm that the price of improved version of product is not lesser than the original product or its parts in comparison.

9. The Bidder shall be deemed to have examined the Bid document, to have obtained his own information in all matters whatsoever that might affect carrying out the Works in line with the Scope of Work specified in the document at the offered rates and to have satisfied himself to the sufficiency of his Bid. The bidder shall be deemed to know the scope, nature and magnitude of the work and requirement of materials, equipment, tools and labour involved, wage structures and as to what all works he has to complete in accordance with the Bid documents irrespective of any defects, omissions or errors that may be found in the Bid documents. In case of non-performance of any bidder, work will be awarded to third party at the risk and cost of the existing bidder.

10. **Insurance:** The Goods supplied under the Contract shall be fully insured in Indian Rupees against loss or damage incidental to manufacture or acquisition, transportation, storage and delivery. For delivery of goods at site, the insurance shall be obtained by the Contractor, for an amount not less than the Contract Price of the goods from “warehouse to warehouse” (final destinations) on “All Risks” basis including War risks and strikes.

The Comprehensive insurance of Solar Photo Voltaic Water Pumping System shall be provided for natural calamities, theft & burglary etc. during 5 years warranty period.

11. Transportation, Demurrage Wharfage, Etc.

Contractor is required under the Contract to transport the Goods to place of destination defined as Site. Transport to such place of destination in India including insurance, as shall be specified in the Contract, shall be arranged by the Contractor, and the related cost shall be included in the Contract Price.

12. Subsequent to an order being placed against bidder’s quotation, received in response to this ‘enquiry’, if it is found that the materials supplied are not of the right quality or not in accordance with our specifications (required by this tender document) or received in damaged or broken conditions, not satisfactory owing to any reason of which we shall be the sole judge, we shall be entitled to reject the materials, cancel the contract and buy our requirement from the open market / other sources and recover the loss, if any, from the bidder reserving to ourselves the right to forfeit the security deposit, furnished by the bidder against the contract. The bidder will make his own arrangements to remove the rejected material within a fortnight of instruction to do so. Thereafter material will lie entirely at the bidder’s risk and responsibility and storage charges, along with any other charges applicable, will be recoverable from the bidder.

13. We reserve the right to accept or reject any quotation in full or in part without assigning any reason thereof. We also reserve the right to split and place order on more than one bidder.

14. The bidder should not have been black-listed by any Central / State Government or Public Sector Undertakings. If at any stage of tendering process or during the currency of the contract, any suppression / falsification of such information is brought to the knowledge, EESL/SNA shall have the right to reject the proposal or terminate the contract, as the case may be, without any compensation to the tenderer & forfeiture of bid security/EMD/CPG.

15. Cost of tender Documents:

Interested bidders may view the tender documents at <https://eesl.eproc.in> or could be viewed after

NIT/Bid Document No.: EESL/06/2019-20/KUSUM/SWPS/Phase-1/Off Grid/ 18072019 Dated:- 18-07-2019	SECTION –4 Technical & SCC	Page 86 of 102
---	-------------------------------	----------------

Signature :-
 Subject : CN=DEEPAK MITTAL, ST=DELHI, OID.2.5.4.17=110003, OU=CONTRACTS AND
 PROCUREMENT, O=ENERGY EFFICIENCY SERVICES LIMITED, C=IN
 User ID : deepak.mittal
 Serial No : F3FA77



following the link of ‘e-Tendering’ on EESL home page, i.e. <http://eeslindia.org> from where the registered bidders [registration process is explained at EESL home page in “E-tendering” section] with EESL will be able to download the tender documents and submit their bids online.

The cost of tender documents is Rs. 25,000/- (Rupees Twenty-Five Thousand Only-Nonrefundable and Non Adjustable) which shall be payable in the form of DD/Pay order or Banker’s Cheque in favour of “Energy Efficiency Services Limited” issued by any scheduled/nationalized bank payable in Noida/New Delhi (under this option the details of DD No. & Date, amount, bankers name etc. has to be submitted in relevant field/column of online module). Tenders without this cost are liable to be rejected. It should be ensured by the bidder that the original DD is received by EESL before opening time of techno-commercial bids for verification of the details of DD given online by the bidders.

The tender submission, tender closing and opening will be done electronically and online.

EESL will not be responsible for any delay, loss or non-receipt of Tender Document Cost sent by post/courier. The instrument should reach in original to EESL office before the Bid Opening date. Bids not accompanied with the requisite tender document cost may not be opened.

16. Bid Security/Earnest Money Deposit (EMD):

Amount of Bid Security: As per Section-1 (IFB)

The bidder shall furnish, as part of its bid, a bid security in a separate envelope. The bid security shall, at the bidder’s option, be in the form of a Banker’s cheque, Demand Draft in favour of “Energy Efficiency Services Limited” or a bank guarantee as per format at attachment 1. Bid security/EMD shall remain valid for a period of 45 days beyond the original bid validity period of 180 days, i.e. 225 days from date of bid opening. If there is any extension in bid validity period, then EESL/SNA may ask the bidder to extend the validity of bid security.

The details of EMD instrument has to be submitted in relevant field/column of online module. Tenders without Earnest Money Deposit is liable to be rejected. It should be ensured by the bidder that the original DD/ BG is received by EESL/SNA before opening time of techno-commercial bids for verification of the details of DD given online by the bidders.

The tender submission, tender closing and opening will be done electronically and online.

EESL will not be responsible for any delay, loss or non-receipt of Tender Document Cost sent by post/courier. The instrument should reach in original to EESL office before the Bid Opening date. Bids not accompanied with the requisite tender document cost may not be opened.

The bid securities of unsuccessful bidders will be returned as promptly as possible after the award is made to lowest evaluated technically acceptable bidder.

The bid security of the successful bidder will be returned when the bidder has signed the contract agreement, and has furnished the required performance security/CPG/BG to the respective SNA.

NIT/Bid Document No.: EESL/06/2019-20/KUSUM/SWPS/Phase-1/Off Grid/ 18072019 Dated:- 18-07-2019	SECTION –4 Technical & SCC	Page 87 of 102
---	-------------------------------	----------------

Signature :
Subject : CN=DEEPAK MITTAL, ST=DELHI, OID.2.5.4.17=110003, OU=CONTRACTS AND
PROCUREMENT, O=ENERGY EFFICIENCY SERVICES LIMITED, C=IN
User ID : deepak.mittal
Serial No : F3FA77



The bid security may be forfeited if:

- a. If the bidder withdraws its bid during the period of bid validity as specified in the bid.
- b. If the bidder does not accept computational/arithmetical error correction made by EESL and as explained in “Financial Evaluation” section of the Bid/ RFP document.
- c. If the bidder does not accept assumptions, estimations etc. used for evaluation of bids as specified by EESL in tender documents and revision of his bid accordingly, in case other assumptions are used. If the bidder does not accept the sharing as specified in the bid.
- d. If the Bidder refuses to withdraw, without any cost to the EESL, any deviation not listed in Attachment 5 but found elsewhere in the bid; or
- e. In the case of successful bidder, if the bidder fails within the specified time limit:
 - To sign the contract agreement within 15 days of placement of LoA.
 - To furnish the required performance guarantee, in accordance with the tender document.

17. Period of Validity of Bid

Bids shall remain valid for a period of 180 days after the closing date prescribed by the EESL for the receipt of bids. A bid valid for a shorter period may be rejected by the EESL as being non responsive. In exceptional circumstances, the EESL may solicit the bidder’s consent to an extension of the bid validity period. The request and response thereto shall be made in writing thro’ letters/ e-mails. If the bidder accepts to prolong the period of validity, the bid security/EMD shall also be suitably extended. A bidder may refuse the request for Bid Validity Extension without forfeiting its bid security. A bidder granting the request will not be required nor permitted to modify its bid.

18. The bidder should not have been black-listed by any Central / State Government or Public Sector Undertakings. If at any stage of tendering process or during the currency of the contract, any suppression / falsification of such information is brought to the knowledge, EESL/SNA shall have the right to reject the proposal or terminate the contract, as the case may be, without any compensation to the tenderer & forfeiture of bid security/EMD/CPG.

19. Statutory Compliance/ Certification regarding Cyber Security Products:

A certificate (in the format at *Attachment-13 of Section-6) is to be submitted by the bidders that the items offered meet the definition of domestically manufactured/produced Cyber Security Products as per MeitY notification vide File no. 1(10)/2017-CLES dt. 02.07.18. The above certificate shall be on Company’s letterhead and signed by Statutory Auditor or Cost Auditor of the Company.

'Cyber Security Products means a product or appliance or software manufactured/ produced for the purpose of protecting, information, equipment, devices computer, computer resource, communication device, and information stored therein from unauthorized access, use, disclosure, disruption, modification or destruction'.

On behalf of EESL

Sd/-

NIT/Bid Document No.: EESL/06/2019-20/KUSUM/SWPS/Phase-1/Off
Grid/ 18072019 Dated:- 18-07-2019

SECTION –4 Technical
& SCC

Page 88 of 102

Signature :-
Subject : CN=DEEPAK MITTAL, ST=DELHI, OID.2.5.4.17=110003, OU=CONTRACTS AN
PROCUREMENT, O=ENERGY EFFICIENCY SERVICES LIMITED, C=IN
User ID : deepak.mittal
Serial No : F3FA77



PRICE BID**(For Indicative purpose. To be filled online only).**

Name of Work: - Design, Manufacture, Supply, Transport, Installation, Testing and Commissioning of approximate 1,75,000 numbers of Off Grid Solar Photovoltaic Water Pumping Systems in selected states on PAN India basis, including complete system warranty and its repair and maintenance for 5 Years under MNRE off-grid and decentralized solar PV applications scheme on behalf of State Nodal Agencies (SNAs).

NIT/Bid Document No.: - EESL/06/2019-20/KUSUM/SWPS /Phase-1/Off Grid/01082019

Dated:- 01-08-2019

Cluster-1 : Andhra Pradesh, Telangana

Package-1 (with normal controller): Design, Manufacture, Supply, Transport, Installation, Testing and Commissioning of Solar Photovoltaic Water Pumping Systems with a Remote Monitoring Facility with repair and maintenance period of 5 Years as per Technical Specification in Annexure-II.

Total quantity to be considered is as per Annexure VII

Sr. No.	Description of Work	Unit of Measurement (UOM)	Total Amount exclusive of GST (IGST/SGST/ CGST/ UGST) (in Rs.) on F.O.R Destination Basis	Total Amount exclusive of GST (IGST/SGST/ CGST/ UGST) (in Rs.) on F.O.R Destination Basis
			(In Figure)	(In Words)
A	1HP DC	1		
B	2HP DC			
C	3HP DC			
D	5HP DC			
E	7.5HP DC			
F	1HP AC			
G	2HP AC			
H	3HP AC			
I	5HP AC			
J	7.5HP AC			

NIT/Bid Document No.: EESL/06/2019-20/KUSUM/SWPS/Phase-1/Off Grid/ 18072019 Dated:- 18-07-2019

SECTION –4 Technical & SCC

Page 89 of 102

Signature :
Subject : CN=DEEPAK MITTAL, ST=DELHI, OID.2.5.4.17=110003, OU=CONTRACTS AND PROCUREMENT, O=ENERGY EFFICIENCY SERVICES LIMITED, C=IN
User ID : deepak.mittal
Serial No : F3FA77



For Cluster-2 – Chhattisgarh, Madhya Pradesh

Package-1 (with normal controller): Design, Manufacture, Supply, Transport, Installation, Testing and Commissioning of Solar Photovoltaic Water Pumping Systems with a Remote Monitoring Facility with repair and maintenance period of 5 Years as per Technical Specification in Annexure-II.

Total quantity to be considered is as per Annexure VII

Sr. No.	Description of Work	Unit of Measurement (UOM)	Total Amount exclusive of GST (IGST/SGST/ CGST/ UGST) (in Rs.) on F.O.R Destination Basis	Total Amount exclusive of GST (IGST/SGST/ CGST/UGST) (in Rs.) on F.O.R Destination Basis
			(In Figure)	(In Words)
A	1HP DC	1		
B	2HP DC			
C	3HP DC			
D	5HP DC			
E	7.5HP DC			
F	1HP AC			
G	2HP AC			
H	3HP AC			
I	5HP AC			
J	7.5HP AC			



For Cluster-3- Rajasthan:-

Package-1 (with normal controller): Design, Manufacture, Supply, Transport, Installation, Testing and Commissioning of Solar Photovoltaic Water Pumping Systems with a Remote Monitoring Facility with repair and maintenance period of 5 Years as per Technical Specification in Annexure-II.

Total quantity to be considered is as per Annexure VII

Sr. No.	Description of Work	Unit of Measurement (UOM)	Total Amount exclusive of GST (IGST/SGST/ CGST/ UGST) (in Rs.) on F.O.R Destination Basis	Total Amount exclusive of GST (IGST/SGST/ CGST/UGST) (in Rs.) on F.O.R Destination Basis
			(In Figure)	(In Words)
A	1HP DC	1		
B	2HP DC			
C	3HP DC			
D	5HP DC			
E	7.5HP DC			
F	1HP AC			
G	2HP AC			
H	3HP AC			
I	5HP AC			
J	7.5HP AC			



For Cluster-4:- Tamil Nadu

Package-1 (with normal controller): Design, Manufacture, Supply, Transport, Installation, Testing and Commissioning of Solar Photovoltaic Water Pumping Systems with a Remote Monitoring Facility with repair and maintenance period of 5 Years as per Technical Specification in Annexure-II.

Total quantity to be considered is as per Annexure VII

Sr. No.	Description of Work	Unit of Measurement (UOM)	Total Amount exclusive of GST (IGST/SGST/CGST/UGST) (in Rs.) on F.O.R Destination Basis	Total Amount exclusive of GST (IGST/SGST/CGST/UGST) (in Rs.) on F.O.R Destination Basis
			(In Figure)	(In Words)
A	1HP DC	1		
B	2HP DC			
C	3HP DC			
D	5HP DC			
E	7.5HP DC			
F	1HP AC			
G	2HP AC			
H	3HP AC			
I	5HP AC			
J	7.5HP AC			



For Cluster-5:- Haryana, Punjab:-

Package-1 (with normal controller): Design, Manufacture, Supply, Transport, Installation, Testing and Commissioning of Solar Photovoltaic Water Pumping Systems with a Remote Monitoring Facility with repair and maintenance period of 5 Years as per Technical Specification in Annexure-II.

Total quantity to be considered is as per Annexure VII

Sr. No.	Description of Work	Unit of Measurement (UOM)	Total Amount exclusive of GST (IGST/SGST/ CGST/ UGST) (in Rs.) on F.O.R Destination Basis	Total Amount exclusive of GST (IGST/SGST/ CGST/UGST) (in Rs.) on F.O.R Destination Basis
			(In Figure)	(In Words)
A	1HP DC	1		
B	2HP DC			
C	3HP DC			
D	5HP DC			
E	7.5HP DC			
F	1HP AC			
G	2HP AC			
H	3HP AC			
I	5HP AC			
J	7.5HP AC			



For Cluster-6- Bihar, West Bengal, Odisha:-

Package-1 (with normal controller): Design, Manufacture, Supply, Transport, Installation, Testing and Commissioning of Solar Photovoltaic Water Pumping Systems with a Remote Monitoring Facility with repair and maintenance period of 5 Years as per Technical Specification in Annexure-II.

Total quantity to be considered is as per Annexure VII

Sr. No.	Description of Work	Unit of Measurement (UOM)	Total Amount exclusive of GST (IGST/SGST/ CGST/ UGST) (in Rs.) on F.O.R Destination Basis	Total Amount exclusive of GST (IGST/SGST/ CGST/UGST) (in Rs.) on F.O.R Destination Basis
			(In Figure)	(In Words)
A	1HP DC	1		
B	2HP DC			
C	3HP DC			
D	5HP DC			
E	7.5HP DC			
F	1HP AC			
G	2HP AC			
H	3HP AC			
I	5HP AC			
J	7.5HP AC			



Cluster-7:- Gujarat, Maharashtra

Package-1 (with normal controller): Design, Manufacture, Supply, Transport, Installation, Testing and Commissioning of Solar Photovoltaic Water Pumping Systems with a Remote Monitoring Facility with repair and maintenance period of 5 Years as per Technical Specification in Annexure-II.

Total quantity to be considered is as per Annexure VII

Sr. No.	Description of Work	Unit of Measurement (UOM)	Total Amount exclusive of GST (IGST/SGST/ CGST/ UGST) (in Rs.) on F.O.R Destination Basis	Total Amount exclusive of GST (IGST/SGST/ CGST/UGST) (in Rs.) on F.O.R Destination Basis
			(In Figure)	(In Words)
A	1HP DC	1		
B	2HP DC			
C	3HP DC			
D	5HP DC			
E	7.5HP DC			
F	1HP AC			
G	2HP AC			
H	3HP AC			
I	5HP AC			
J	7.5HP AC			



Cluster-8:- Jharkhand, Uttar Pradesh

Package-1 (with normal controller): Design, Manufacture, Supply, Transport, Installation, Testing and Commissioning of Solar Photovoltaic Water Pumping Systems with a Remote Monitoring Facility with repair and maintenance period of 5 Years as per Technical Specification in Annexure-II.

Total quantity to be considered is as per Annexure VII

Sr. No.	Description of Work	Unit of Measurement (UOM)	Total Amount exclusive of GST (IGST/SGST/ CGST/ UGST) (in Rs.) on F.O.R Destination Basis	Total Amount exclusive of GST (IGST/SGST/ CGST/UGST) (in Rs.) on F.O.R Destination Basis
			(In Figure)	(In Words)
A	1HP DC	1		
B	2HP DC			
C	3HP DC			
D	5HP DC			
E	7.5HP DC			
F	1HP AC			
G	2HP AC			
H	3HP AC			
I	5HP AC			
J	7.5HP AC			



Cluster-9:- Himachal Pradesh, Jammu & Kashmir, Uttarakhand:-

Package-1 (with normal controller): Design, Manufacture, Supply, Transport, Installation, Testing and Commissioning of Solar Photovoltaic Water Pumping Systems with a Remote Monitoring Facility with repair and maintenance period of 5 Years as per Technical Specification in Annexure-II.

Total quantity to be considered is as per Annexure VII

Sr. No.	Description of Work	Unit of Measurement (UOM)	Total Amount exclusive of GST (IGST/SGST/ CGST/ UGST) (in Rs.) on F.O.R Destination Basis	Total Amount exclusive of GST (IGST/SGST/ CGST/UGST) (in Rs.) on F.O.R Destination Basis
			(In Figure)	(In Words)
A	1HP DC	1		
B	2HP DC			
C	3HP DC			
D	5HP DC			
E	7.5HP DC			
F	1HP AC			
G	2HP AC			
H	3HP AC			
I	5HP AC			
J	7.5HP AC			

NIT/Bid Document No.: EESL/06/2019-20/KUSUM/SWPS/Phase-1/Off
Grid/ 18072019 Dated:- 18-07-2019

SECTION –4 Technical
& SCC

Page 97 of 102

Signature :-
Subject : CN=DEEPAK MITTAL, ST=DELHI, OID.2.5.4.17=110003, OU=CONTRACTS AND
PROCUREMENT, O=ENERGY EFFICIENCY SERVICES LIMITED, C=IN
User ID : deepak.mittal
Serial No : F3FA77



Cluster-10 - Meghalaya, Mizoram, Tripura, Assam

Package-1 (with normal controller): Design, Manufacture, Supply, Transport, Installation, Testing and Commissioning of Solar Photovoltaic Water Pumping Systems with a Remote Monitoring Facility with repair and maintenance period of 5 Years as per Technical Specification in Annexure-II.

Total quantity to be considered is as per Annexure VII

Sr. No.	Description of Work	Unit of Measurement (UOM)	Total Amount exclusive of GST (IGST/SGST/ CGST/ UGST) (in Rs.) on F.O.R Destination Basis	Total Amount exclusive of GST (IGST/SGST/ CGST/UGST) (in Rs.) on F.O.R Destination Basis
			(In Figure)	(In Words)
A	1HP DC	1		
B	2HP DC			
C	3HP DC			
D	5HP DC			
E	7.5HP DC			
F	1HP AC			
G	2HP AC			
H	3HP AC			
I	5HP AC			
J	7.5HP AC			



Price bid (Difference in price with Universal Solar Pump controller): Difference in price for Design, Manufacture, Supply, Transport, Installation, Testing and Commissioning of Solar Photovoltaic Water Pumping Systems with a Remote Monitoring Facility with repair and maintenance period of 5 Years as per Technical Specification in Annexure-II.

Sr. No.	Description of Work	Unit of Measurement (UOM)	Total Amount exclusive of GST (IGST/SGST/ CGST/ UGST) (in Rs.) on F.O.R Destination Basis	Total Amount exclusive of GST (IGST/SGST/ CGST/ UGST) (in Rs.) on F.O.R Destination Basis
			(In Figure)	(In Words)
A	1HP DC	1		
B	2HP DC			
C	3HP DC			
D	5HP DC			
E	7.5HP DC			
F	1HP AC			
G	2HP AC			
H	3HP AC			
I	5HP AC			
J	7.5HP AC			

Notes:

1. Difference amount to be quoted in the above price bid table (with Universal Solar Pump Controller). For ex: If a bidder quotes 3 Lakh for 5HP DC SPWPS (with normal controller) as per cluster wise price bid table, and bidder estimate cost of 5HP DC SPWPS (with Universal Solar Pump Controller) to be 3.4 Lakh, then bidder shall quote 0.4 Lakhs in the 5 HP DC category of above price table.
2. Price quoted in the above table will be paid by the Farmer directly.
3. Price quoted in the above table shall be valid for all clusters.
4. It will be on sole discretion of the farmer to opt for SPWPS with Universal Solar Pump Controller.
5. Successful bidder shall match the price of L1 bidder for SPWPS with Universal Solar Pump Controller.
6. The prices for SPWPS (with Universal Solar Pump Controller) will not be considered for price bid evaluation.
7. Bidder has to mandatory quote for the SPWPS (with Universal Solar Pump Controller).

NIT/Bid Document No.: EESL/06/2019-20/KUSUM/SWPS/Phase-1/Off Grid/ 18072019 Dated:- 18-07-2019	SECTION –4 Technical & SCC	Page 99 of 102
--	----------------------------	----------------

Signature :
 Subject : CN=DEEPAK MITTAL, ST=DELHI, OID.2.5.4.17=110003, OU=CONTRACTS AND PROCUREMENT, O=ENERGY EFFICIENCY SERVICES LIMITED, C=IN
 User ID : deepak.mittal
 Serial No : F3FA77



Other terms and conditions

1. The Bidder shall indicate in the Price Bid, the unit prices in Rs. (INR) and total Bid prices of the Goods & Services in the prescribed format only. Bidders shall quote for the complete requirement of Goods and Services specified under the Contract on a single responsibility basis, failing which such Bids will not be taken into account for evaluation and will not be considered for award.
2. The bidder should compulsorily quote for all heads in the price-bid format for which separate analysis/ reasonable estimation of all heads should be done by the bidder before quoting the rates in the financial bid. Any contravention may lead to rejection of offer submitted.
3. If there is a discrepancy between words and figures, the amount written in words will prevail.
4. Any other item as required for commissioning the system for reliable and efficient operation to be provided within the quoted price.
5. Any other item as required for commissioning the system for reliable and efficient operation to be provided within the quoted price.
6. The above prices are exclusive of GST.
7. The bidder shall submit PAN and GST Registration Certificate in support of claim of GST.
8. Please note that selection of the bidder will be done on the technically acceptable and L-1 (Lowest One) price basis. Bidder should quote for complete scope of work as defined above.
9. Bidder's to quote for all items otherwise their bid will be rejected.
10. Prices will remain firm till the execution of the contract and nothing shall be payable extra apart from the prices quoted abo

I/We have read all the terms and conditions of the RfP/IFB/NIT and the Annexure(s) thereto and agree to accept and abide by the same in toto. The above quotation has been prepared after taking into account all the terms and conditions of the RfP/IFB/NIT.

Dated:

(SEAL)

Signature of Tenderer or
Their Authorized Representative:

Name & Address of Tenderer:
Phone No:
Fax no.:

NIT/Bid Document No.: EESL/06/2019-20/KUSUM/SWPS/Phase-1/Off
Grid/ 18072019 Dated:- 18-07-2019

SECTION –4 Technical
& SCC

Page 100 of 102

Signature :
Subject : CN=DEEPAK MITTAL, ST=DELHI, OID.2.5.4.17=110003, OU=CONTRACTS AND
PROCUREMENT, O=ENERGY EFFICIENCY SERVICES LIMITED, C=IN
User ID : deepak.mittal
Serial No : F3FA77



Annexure-VII

Following shall be the list of allocations approved to various States/UTs:

Cluster. No.	State	No. of Pumps
1	Andhra Pradesh	25000
	Telangana	1000
	Total	26000
2	Chattisgarh	15000
	Madhya Pradesh	12600
	Total	27600
3	Rajasthan	25000
	Total	25000
4	Tamil Nadu	25000
	Total	25000
5	Haryana	15000
	Punjab	4500
	Total	19500
6	Bihar	2500
	West Bengal	700
	Odisha	2500
	Total	5700
7	Gujarat	4000
	Maharashtra	9000
	Total	13000
8	Jharkhand	10000
	Uttar Pradesh	15000
	Total	25000
9	Himachal Pradesh	1700
	Jammu & Kashmir	1000
	Uttarakhand	300
	Total	3000
10	Meghalaya	1700
	Mizoram	200
	Tripura	1300
	Assam	700
	Total	3900
	Grand Total	173700

Cluster wise W1, W2, W3, W4, W5, W6, W7, W8, W9, W10 to be used for price bid evaluation:

Cluster	W1	W2	W3	W4	W5	W6	W7	W8	W9	W10	Total
	1HP DC	2HP DC	3HP DC	5HP DC	7.5HP DC	1HP AC	2HP AC	3HP AC	1HP AC	7.5HP AC	
1											1
2											1
3											1
4											1
5											1
6											1
7											1
8											1
9											1
10											1

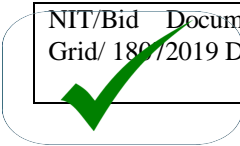



SECTION-5

1. Measurement and Verification (M&V)

NA for this tender.



SECTION-6

Forms & Procedures

ATTACHMENT – 1

BID FORM

To,

Energy Efficiency Services Limited.
(A JV of PSUs of Ministry of Power, Govt. of India)
Core-3, 6th Floor,
SCOPE Complex,
Lodhi Road, New Delhi-110003

Subject:-IFB/RfP No/Package No. Due for opening on

Dear Sir,

With Reference to your subject IFB/RfP, we are pleased to submit our bid for “.....” in a sealed cover as detailed below:

Envelope I: Bid document fee/cost of tender documents [wherever applicable], Bid Security fees/Earnest Money Deposit, Bid Form, Power of attorney, Certificate regarding acceptance of important terms and conditions, Form of acceptance of EESL fraud prevention policy.

Envelope II: Deviation statement, Techno-commercial bid, Signed copy of RfP and subsequent amendments, if any.

Envelope III: Price Bid

We confirm that we have quoted as per instructions and terms and conditions of tender documents. We have submitted all the four attachments as stated in “Instructions to Bidders”

We declare that the prices left blank in price schedule/price bid will be deemed to have been included in the prices of other items. We confirm that except as otherwise specifically provided, our bid prices include all applicable taxes including service tax, entry tax(if any) , duties , levies , charges as may be assessed on us.

We further declare that additional conditions, variations, deviations, if any, found in the proposal other than those listed in Attachment-5 save those pertaining to any rebates offered, shall not be given effect to.

We undertake, if our bid is accepted, we shall commence the work immediately upon your Letter of Intent /Letter of Award to us, to achieve completion of work within the time specified in the bidding documents.

If our bid is accepted, we undertake to provide contract performance securities and securities for Deed(s) of Joint Undertaking (as applicable) in the form and amounts and within the times specified in the bidding documents.

We agree to abide by this bid for a period 180 days from the date of opening of bids as stipulated in the bidding documents and it shall remain binding upon us and may be accepted by you at any time before the expiration of that period. Further, the prices of recommended spares, if asked for; contained in our bid shall re-main valid for the entire project period after placement of Lol/LoA.

Until a formal contract is prepared and executed between us, this bid, together with your written acceptance thereof in the form of your Letter of Intent/ Letter of Award shall constitute a binding contract between us.

We understand that you are not bound to accept the lowest or any other bid you may receive.

 We, hereby declare that only the persons or firms interested in this proposal as principals are named here and that no other persons or firms other than those mentioned herein have any interest in this proposal or in the contract to be entered into, if the award is made on us, that this proposal is made

Signature :-
Subject : CN=DEEPAK MITTAL, ST=DELHI, OID.2.5.4.17=110003, OU=CONTRACTS AN
PROCESSED BY: ENERGY EFFICIENCY SERVICES LIMITED, C.O.P.
Date: 11/06/2014
Serial No: F3FA77

without any connection with any other person, firm or party likewise submitting a proposal, is in all respects for and in good faith, without collusion or fraud.

Dated -----

NAME/S & AUTHORIZED SIGNATORIES

ADDRESS :

MOBILE NO. :

LAND LINE NO. :

Our correspondence details are:

1	Name of the bidder	
2	Address of the bidder	
3	Name of the contact person to whom all references shall be made regarding this tender	
4	Designation of the person to whom all references shall be made regarding this tender	
5	Address of the person to whom all references shall be made regarding this tender	
6	Telephone (with STD code)	
7	E-Mail of the contact person	
8	Fax No. (with STD code)	
9	GST No. of the bidder	



Signature :-
Subject : CN=DEEPAK MITTAL, ST=DELHI, OID.2.5.4.17=110003, OU=CONTRACTS AN
PROCUREMENT, O=ENERGY EFFICIENCY SERVICES LIMITED, C=IN
User ID : deepak.mittal
Serial No : F3FA77

**Bid Security Form
Bank Guarantee**

(To be stamped in accordance with Stamp Act, if any, of the country of the issuing Bank)

Bank Guarantee No.

Date.....

To:

Energy Efficiency Services Limited.
(A JV of PSUs of Ministry of Power, Govt. of India)
Core-3, 6th Floor,
SCOPE Complex,
Lodhi Road, New Delhi-110003.

Dear Sir(s),

In accordance with invitation for bids under your bidding document/package no.....dated.....M/s.....havi ng its registered/head office at.....(here in after called "Bidder") wish to participate in the said bid for (name of package)

We, the (Name and address of the bank), having our head office atguarantee and undertake to pay immediately on demand by Energy Efficiency services Limited, the amount ofwithout any reservation, protest, recourse. Any such demand made by the employer shall be conclusive and binding on us irrespective of any dispute or difference raised by the bidder.

The Guarantee shall be irrevocable and shall remain valid upto If any further extension of guarantee is required, the same shall be extended to such period (not exceeding one year) on receiving instructions from.....(Bidder's Name)....., on whose behalf guarantee is issued.

In witness whereof the bank, through its authorized officer, has set its hand and stamp on this.....day of20.....at.....

Witness:

Signature:

Name:

Official address:

Signature:

Name :

Designation with Bank Stamp

Authorized vide

Power of Attorney no.

Date

NOTE:

- Bid Security amount shall be as specified in the IFB/ITB. Complete mailing address of the Head Office of the Bank to be given. The bank guarantee validity date shall be forty five (45) days after the last date for which the bid is valid.
- The Stamp Paper of appropriate value shall be purchased in the name of guarantee issuing Bank. The Bank Guarantee shall be issued on a stamp paper of value as applicable in the State of the issuing bank in India or the State of Delhi in India or the State of India from where the BG shall be operated, whichever is higher.
- While getting the Bank Guarantee issued, Bidders are required to ensure compliance to the Bank Guarantee Verification Check List. Further, Bidders are required to fill up this Form 16 and enclose the same with the Bank Guarantee.



Subject : CN=DEEPAK MITTAL@SI=DELHI, Oid.2.5.4.17=110003, OU=CONTRACTS AN
PROCUREMENT-TO-ENERGY EFFICIENCY SERVICES LIMITED, C=IN
Serial No. 43FA77

BANK GUARANTEE CHECK LIST

1	Bank Guarantee No.	
2	Issuing Bank	
3	Nature of BG & No. of Pages	
4	Validity of BG	
5	Package Description	
6	Party & Contracts ref.	Name, Address, Tel, Fax, E—mail
7	Bank Reference	

CHECK LIST

Sl.No.	Details of Checks	YES / NO
a)	Is the BG on non-judicial Stamp Paper of appropriate value, as per Stamp Act ?	
b)	Whether date, purpose of purchase of stamp paper and name of the purchaser are indicated on the back of Stamp paper under the Signature of Stamp vendor? (The date of purchase of stamp paper should be not later than the date of execution of BG and the stamp paper should be purchased either in the name of the executing Bank or the party on whose behalf the BG has been issued. Also the Stamp Paper should not be older than six months from the date of execution of BG)	
c)	In case the BG has been executed on Letter Head of the Bank, whether adhesive Stamp of appropriate value has been affixed thereon?	
d)	Has the executing Officer of BG indicated the name, designation and Power of Attorney No. / Signing Power no. etc., on the BG ?	
e)	Is each page of BG duly signed / initiated by executants and whether stamp of Bank is affixed thereon? Whether the last page is signed with full particulars including two witnesses under seal of Bank as required in the prescribed proforma?	
f)	Does the Bank Guarantees compare verbatim with the proforma prescribed in the bid documents ?	
g)	In case of any changes in contents of text, whether changes are of minor/clerical nature (which in no way limits the right of EESL in any manner) ?	
h)	Incase of deviations in text of BG, which materially affect the right of EESL, whether the changes have been agreed based on the opinion by Legal Department or BG I considered acceptable on the basis of opinion of law Department already available on the similar issue.	
i)	Are the factual details such as Bid Document No. NOA/LOA/Contact No., Contract Price, Percentage of Advance, Amount of BG and Validity of BG correctly mentioned in the BG ?	
j)	Whether overwriting / cutting if any on the BG have been properly authenticated under signature and seal of executant ?	
k)	Whether the BG has been issued by a Bank in line with the provisions of Bid /Contract documents ?	
l)	In case BG has been issued by a Bank other than those specified of Bid / Contract Documents, is the BG confirmed by a Bank in India acceptable as per Bid / Contract documents?	



ANNEXURE-I

LIST OF BANKS ACCEPTABLE FOR SUBMISSION OF BANK GUARANTEE FOR BID SECURITY

SCHEDULED COMMERCIAL BANKS

• **SBI AND ASSOCIATES**

Sl.No.	Name of Banks	Sl. No.	Name of Banks
1.	State Bank of India	5.	State Bank of Mysore
2.	State Bank of Bikaner and Jaipur	6.	State Bank of Patiala
3.	State Bank of Hyderabad	7.	State Bank of Saurashtra
4.	State Bank of Indore	8.	State Bank of Travancore

• **NATIONALISED BANKS**

Sl.No.	Name of Banks	Sl. No.	Name of Banks
9.	Allahabad Bank	13.	Canara Bank
10.	Andhra Bank	14.	Central Bank of India
11.	Bank of India	15.	Corporation Bank
12.	Bank of Maharashtra	16.	Dena Bank
17.	Indian Bank	18.	Indian Overseas Bank
19.	Oriental Bank of Commerce	20.	Punjab National Bank
21.	Punjab & Sind Bank	22.	Syndicate Bank
23.	Union Bank of India	24.	United Bank of India
25.	UCO Bank	26.	Vijaya Bank
27.	Bank of Baroda		

• **SCHEDULED PRIVATE BANKS (INDIAN BANKS)**

Sl.No.	Name of Banks	Sl. No.	Name of Banks
27.	Bank of Rajasthan	41.	Sangli Bank Ltd.
28.	Bharat Overseas Bank Ltd.	42.	South Indian Bank Ltd.
29.	Catholic Syrian Bank	43.	Tamilnad Mercantile Bank Ltd.
30.	City Union Bank	44.	United Western Bank Ltd.
31.	Dhanalakshmi Bank	45.	ING Vysya Bank Ltd.
32.	Federal Bank Ltd.	46.	UTI Bank Ltd.
33.	Jammu & Kashmir Bank Ltd.	47.	S.B.I. Commercial & International Bank Ltd.
34.	Karnataka Bank Ltd.	48.	Ganesh Bank of Kurundwad Ltd.
35.	Karuvysya Bank Ltd.	49.	INDUSIND Bank Ltd.
36.	Lakshmi Vilas Bank Ltd.	50.	ICICI Bank Ltd.
37.	Lord Krishna Bank Ltd.	51.	HDFC Bank Ltd.
38.	Nainital Bank Ltd.	52.	Centurion Bank of Punjab Limited
39.	Kotak Mahindra Bank	53.	Development Credit Bank Ltd.
40.	Ratnakar Bank Ltd.	54.	Yes Bank

(D) SCHEDULED PRIVATE BANKS (FOREIGN BANKS)

Sl.No.	Name of Banks	Sl. No.	Name of Banks
55.	Abu Dhabi Commercial Bank Ltd.	71.	Sonali Bank
56.	ABN Amro Bank Ltd.	72.	Standard Chartered Bank
57.	American Express Bank Ltd.	73.	J.P Morgan Chase Bank
58.	Bank of America NA	74.	State Bank of Mauritius
59.	Bank of Bahrain & Kuwait	75.	Development Bank of Singapore
60.	Mashreq Bank	76.	Bank of Ceylon
61.	Bank of Nova Scotia	77.	Bank International Indonesia
62.	The Bank of Tokyo-Mitsubishi UFJ	78.	Arab Bangladesh Bank

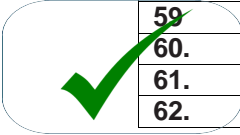

	Limited.		
63.	Calyon Bank	79.	Cho Hung Bank
64.	BNP Paribas	80.	China Trust Bank
65.	Barclays Bank	81.	Mizuho Corporate Bank Ltd.
66.	Citi Bank	82.	Krung Thai Bank
67.	Deutsche Bank	83.	Antwerp Diamond Bank N.V. Belgium
68.	The Hong Kong and Shanghai Banking Corporation Ltd.	84.	InternationaleNederlanden Bank N.V. (ING Bank)
69.	Oman International Bank	85.	Bank of China Ltd.
70.	SocieteGenerale		

(E) PUBLIC SECTOR BANK

Sl.No.	Name of Banks	Sl. No.	Name of Banks
86.	IDBI Ltd.		



Signature :-
Subject : CN=DEEPAK MITTAL, ST=DELHI, OID.2.5.4.17=110003, OU=CONTRACTS AN
PROCUREMENT, O=ENERGY EFFICIENCY SERVICES LIMITED, C=IN
User ID : deepak.mittal
Serial No : F3FA77

Tender Document No/Package No:

Dated:

Package Details.....

POWER OF ATTORNEY

BIDDER TO ATTACH THE POWER OF ATTORNEY IN THEIR OWN FORMAT



Signature :-
Subject : CN=DEEPAK MITTAL, ST=DELHI, OID.2.5.4.17=110003, OU=CONTRACTS AND
PROCUREMENT, O=ENERGY EFFICIENCY SERVICES LIMITED, C=IN
User ID : deepak.mittal
Serial No : F3FA77

ATTACHMENT - 4

Tender Document No/Package No:

Dated:

(CERTIFICATE REGARDING ACCEPTANCE OF IMPORTANT CONDITIONS)

Bidder's Name& Address

To,
CGM (SCM),
Energy Efficiency Services Limited,
Core-3, 6th Floor,
SCOPE Complex,
Lodhi Road, New Delhi-110003

Sub:

1.0 With reference to our bid proposal no.....dated.....**for**
...../ **Package no.** **Dated**
....., we hereby confirm that we have read the following provisions of the following
clauses and further confirm that notwithstanding anything stated elsewhere to the contrary, the
stipulation of these clauses are acceptable to us and we have not taken any deviation to these
clauses.

- Governing Laws - Clause 7 of ITB
- Settlement of Disputes - Clause 17 of ITB
- Terms of payment - Clause 1.0 of SCC
- Performance Security - Clause 5.9 of ITB
- Taxes and Duties - Clause 8 of ITB
- Completion Time Guarantee - Clause 9 of ITB
- Defects Liability - Clause 10 of ITB
- Functional Guarantee - Clause 11 of ITB
- Patent Indemnity - Clause 2.25 of ITB
- Limitations of Liability - Clause 2.27 of ITB
- Project information, Estimation, Assumptions and conditions for Evaluation - As per Tables in price bid

We further confirm that any deviation to the above clauses found anywhere in our bid proposal, implicit or explicit, shall stand unconditionally withdrawn, without any implication to EESL.

Date:

Signature:

Place:

Printed Name:

Designation:

Common Seal

Note: In the absence of this certificate, the bid shall be rejected and shall be returned unopened. Bidder can take a print out of it and sign.



Signature :-
Subject : CN=DEEPAK MITTAL, ST=DELHI, OID.2.5.4.17=110003, OU=CONTRACTS AN
PROCUREMENT, O=ENERGY EFFICIENCY SERVICES LIMITED, C=IN
User ID : deepak.mittal
Serial No : F3FA77

ATTACHMENT - 5

NAME OF WORK:.....

BIDDING DOCUMENT NO.....

(Deviations Statement)

Bidder's Name and Address:

To,

General Manager (C & P)
Energy Efficiency Services Limited.
(A JV of PSUs of Ministry of Power, Govt. of India)
C/o Projects & Development India Ltd.,
PDIL Bhawan, 1st Floor, A-14, Sector-1,
NOIDA-201 301, Distt. Gautam Budh Nagar, U.P.

Dear Sir,

The following are the deviations and variations from and exceptions to the terms, conditions and specification of the bidding documents for IFB/RfP No. These deviations and variations are exhaustive. We are furnishing below the cost of withdrawal for the deviations and variations stated in this Attachment. We shall withdraw the deviations proposed by us in this Attachment at the cost of withdrawal indicated herein, failing which our bid may be rejected and bid security may be forfeited. We confirm that except for these deviations and variations, the entire work shall be performed as per your specifications and conditions of bidding documents. Further, we agree that additional conditions, variations, deviations if any, found in the proposal documents other than those stated in this Attachment, save those pertaining to any rebates offered, shall not be given effect to:

Section/ Part/ Chapter	Clause No.	Page No.	Statement of Deviations/ Variations	Cost of withdrawal
------------------------------	---------------	-------------	---	--------------------

A. COMMERCIAL DEVIATIONS :

B. TECHNICAL DEVIATIONS :

Date : (Signature).....

Place : (Printed Name).....

(Designation).....

(Common Seal)

Note: Continuations sheets of like size and format may be used as per Bidder's requirement.

Signature :
Subject : CN=DEEPAK MITTAL, ST=DELHI, OID.2.5.4.17=110003, OU=CONTRACTS AN
PROCUREMENT, O=ENERGY EFFICIENCY SERVICES LIMITED, C=IN
User ID : deepak.mittal
Serial No : F3FA77



(On Non – Judicial Stamp Paper of appropriate value and purchased in the name of executing Bank)

PROFORMA OF BANK GUARANTEE FOR CONTRACT PERFORMANCE

Ref.:
Bank Guarantee No.....
Date.....

To,
Energy Efficiency Services Limited,
Core-3, 6th Floor,
SCOPE Complex,
Lodhi Road, New Delhi-110003
Dear Sirs,

In consideration of the EESL, (hereinafter referred to as the 'Owner,' which expression shall unless repugnant to the context or meaning thereof include its successors, administrators and assigns) having awarded to M/s.....with its Registered / Head Office at(hereinafter referred to as the 'Contractor', which expression shall unless repugnant to the context or meaning thereof, include its successors, administrators and assigns), a Contract by issue of Owner's Letter of Award No.....datedand the same having been unequivocally accepted by the Contractor and the contractor (Scope of Contract) having agreed to provide a Contract Performance Guarantee for the faithful performance of the entire Contract equivalent to * % (percent) of the said value of the Contract to the Owner.

We(Name & address) having its Head Office at(hereinafter referred to as the 'Bank', which expression shall, unless repugnant to the context or meaning thereof, include its successors administrators, executors and assigns) do hereby guarantee and undertake to pay the Owner, on demand any all money payable by the Contractor to the extent ofas aforesaid at any time up to(days/months/year) without any demur, reservation, contest, recourse or protest and / or without any reference to the Contractor. Any such demand made by the Owner on the Bank shall be conclusive and binding notwithstanding any difference between the Owner and the Contractor or any dispute pending before any court, tribunal, Arbitrator or any other authority. The Bank undertakes not to revoke this guarantee during its currency without previous consent of the Owner and further agrees that the guarantee herein contained shall continue to be enforceable till the owner discharges this guarantee.

The owner shall have the fullest liberty without affecting in any way the liability of the Bank under this guarantee from time to time to extent the time for performance of the Contract by the Contractor. The owner shall have the fullest liberty, without affecting this guarantee, to postpone from time to time the exercise of any powers vested in them or of any right which they to enforce or to forbear to enforce any covenants, contained or implied, in the Contract between the owner and Contractor or any other course of or remedy or security available to the owner. The Bank shall not be released of its obligations under these presents by any exercise by the owner of its liberty with reference to the matters aforesaid on any of other indulgence shown by the owner or by any other matter or thing whatsoever which under law would, but for this provision, have the effect of relieving the Bank.

The Bank also agree that the Owner at its option shall be entitled to enforce this Guarantee against the Bank as a Principal debtor, in the first instance without proceeding against the Contractor and not withstanding any security or other guarantee that the owner may have in relation to the Contractor's liabilities.

Notwithstanding anything contained herein above our liability under this guarantee is restricted to.....and it shall remain in force up to and including**.....and shall be extended from time to time for such period (not exceeding one year), as may be desired by M/s.....on whose behalf this guarantee has been given.



Witness
Signature :-
Subject : CN=DEEPAK MITTAL, ST=DELHI, OID.2.5.4.17=110003, OU=CONTRACTS AN
PROCUREMENT, O=ENERGY EFFICIENCY SERVICES LIMITED, C=IN
User ID : deepak.mittal
Serial No : F3FA77

Dated thisday of.....at.....

Witness

.....

Signature

.....

Name

.....

Official Address

.....

Signature

.....

Bank's Rubber Stamp

Name

Designation with Bank Stamp

Attorney as per power of Attorney

No.....dated.....

Note: ** Validity of Bank Guarantee should be 90 days in excess of the period for which it is required.

BANK GUARANTEE CHECK LIST

1	Bank Guarantee No.	
2	Issuing Bank	
4	Nature of BG & No. of Pages	
5	Validity of BG	
6	Package Description	
7	Party & Contracts ref.	Name, Address, Tel, Fax, E—mail
8	Bank Reference	

CHECK LIST

S.No.	Details of Checks	YES / NO
a)	Is the BG on non-judicial Stamp Paper of appropriate value, as per Stamp Act ?	
b)	Whether date, purpose of purchase of stamp paper and name of the purchaser are indicated on the back of Stamp paper under the Signature of Stamp vendor? (The date of purchase of stamp paper should be not later than the date of execution of BG and the stamp paper should be purchased either in the name of the executing Bank or the party on whose behalf the BG has been issued. Also the Stamp Paper should not be older than six months from the date of execution of BG)	
c)	In case the BG has been executed on Letter Head of the Bank, whether adhesive Stamp of appropriate value has been affixed thereon?	
d)	Has the executing Officer of BG indicated the name, designation and Power of Attorney No./ Signing Power no. etc., on the BG?	
e)	Is each page of BG duly signed / initiated by executants and whether stamp of Bank is affixed thereon? Whether the last page is signed with full particulars including two witnesses under seal of Bank as required in the prescribed proforma?	
f)	Does the Bank Guarantees compare verbatim with the Proforma prescribed in the Bid Documents?	
g)	In case of any changes in contents of text, whether changes are of minor / clerical nature (which in no way limits the right of EESL in any manner)?	
h)	Incase of deviations in text of BG, which materially affect the right of EESL, whether the changes have been agreed based on the opinion by Legal Department or BG I considered acceptable on the basis of opinion of law Department already available on the similar issue.	
i)	Are the factual details such as Bid Document No.NOA/LOA / Contact No., Contract Price, Percentage of Advance, Amount of BG and Validity of BG correctly mentioned in the BG?	
j)	Whether overwriting / cutting if any on the BG have been properly authenticated under signature and seal of executant?	
k)	Whether the BG has been issued by a Bank in line with the provisions of Bid / Contract documents?	
l)	In case BG has been issued by a Bank other than those specified of Bid / Contract Documents, is the BG confirmed by a Bank in India acceptable as per Bid / Contract documents?	

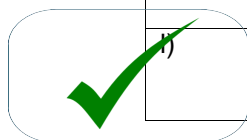

Source: C:\EESL\BID\BID-2017-110003-01-CONTRACTS.M
Project: C:\EESL\BID\BID-2017-110003-01-CONTRACTS.M
User: J:\Sakshita
Serial No: EFAAT

**LIST OF BANKS ACCEPTABLE FOR SUBMISSION OF BANK GUARANTEES FOR
ADVANCE PAYMENTS, PERFORMANCE SECURITIES AND SECURITIES FOR
DEED OF JOINT UNDERTAKING
SCHEDULED COMMERCIAL BANKS**

• **SBI and Associates**

Sl.No.	Name of Banks	Sl. No.	Name of Banks
1.	State Bank of India	5.	State Bank of Mysore
2.	State Bank of Bikaner and Jaipur	6.	State Bank of Patiala
3.	State Bank of Hyderabad	7.	State Bank of Saurashtra
4.	State Bank of Indore	8.	State Bank of Travancore

• **Nationalised Banks**

Sl.No.	Name of Banks	Sl. No.	Name of Banks
9.	Allahabad Bank	18.	Indian Overseas Bank
10.	Bank of India	19.	Oriental Bank of Commerce
11.	Bank of Maharashtra	20.	Punjab National Bank
12.	Canara Bank	21.	Punjab & Sind Bank
13.	Central Bank of India	22.	Syndicate Bank
14.	Corporation Bank	23.	Union Bank of India
15.	Dena Bank	24.	United Bank of India
16.	Indian Bank	25.	UCO Bank
17.	Vijaya Bank	26.	Bank of Baroda

C. Foreign Banks

Sl.No.	Name of Banks	Sl. No.	Name of Banks
27.	Bank of America NA	34.	Standard Chartered Bank
28.	The Bank of Tokyo-Mitsubishi UFJ Limited.	35.	SocieteGenerale
29.	BNP Paribas	36.	Barclays Bank
30.	Calyon Bank	37.	ABN Amro Bank N. V.
31.	Citi Bank N.A.	38.	Bank of Nova Scotia
32.	Deutsche Bank A. G.	39.	Development Bank of Singapore
33.	The Hong Kong and Shanghai Banking Corporation Ltd.		

D. SCHEDULED PRIVATE BANKS

Sl.No.	Name of Banks	Sl. No.	Name of Banks
40.	ING Vysya Bank Ltd.	43.	UTI Bank Ltd.
41.	ICICI Bank Ltd.	44.	YES Bank
42.	HDFC Bank Ltd.		

E. Other Public Sector Banks

Sl.No.	Name of Banks	Sl. No.	Name of Banks
45.	IDBI Ltd.		



FORM OF ACCEPTANCE OF FRAUD PREVENTION POLICY
(On the letter head)

To:

CGM (SCM),
Energy Efficiency Services Limited,
Core-3, 6th Floor,
SCOPE Complex,
Lodhi Road, New Delhi-110003

Sub: Letter of Acceptance of EESL Fraud Policy
Ref: NIT/RFP No.

Dear Sir/Madam,

We have read the contents of the Fraud Prevention Policy of EESL and undertake that we along with our associate / collaborator /sub contractors / sub-vendors / bidders/ service providers shall strictly abide by the provisions of the Fraud Prevention Policy of EESL.

Thanking You,

Yours faithfully,

Signature

Printed Name

Designation.....

Common Seal.....

Date:

Place:

FOR DETAILED POLICY, PLEASE VISIT OUR WEBSITE www.eeslindia.org



Signature :-
Subject : CN=DEEPAK MITTAL, ST=DELHI, OID.2.5.4.17=110003, OU=CONTRACTS AN
PROCUREMENT, O=ENERGY EFFICIENCY SERVICES LIMITED, C=IN
User ID : deepak.mittal
Serial No : F3FA77

PROFORMA OF BANK GUARANTEE FOR ADVANCE PAYMENT

(To be stamped in accordance with Stamp Act If any, of the Country of the issuing Bank)

To,
Energy Efficiency Services Limited,
Core-3, 6th Floor,
SCOPE Complex,
Lodhi Road, New Delhi-110003

Dear Sir,

In consideration of (Employer's Name).... (here in after referred to as the 'Employer', which expression shall, unless repugnant to the context of meaning thereof include its successors, administrators and assigns) having awarded to M/s.....(Contractor's Name)....with its Registered /Head Office at.....(hereinafter referred to as the 'Contractor' which expression in shall unless repugnant to the context or meaning thereof , include its successors, administrators, executors and assigns), a Contract, by issue of Employer's Letter of Award No.....dated.....and the same having been unequivocally accepted by the Contractor, resulting into a Contract bearing No.....dated.....valued atfor.....(Name of Contract).....(hereinafter called the 'Contract') and the Employer having agreed to make an advance ('said Advance') to the Contractor amounting to (in words and figures).....in terms of the said Contract for performance of the above Contract against Bank Guarantee to be furnished by the Contractor.

We.....(Name and address of the Bank).....having its Head Office at (hereinafter referred to as the 'Bank', which expression shall, unless repugnant to the context or meaning thereof, include its successors, administrators, executors and assigns) do hereby guarantee and undertake to pay the Employer, immediately on demand any or, all monies payable by the Contractor to the extent of(advance amount).....as aforesaid at any time up to.....(#).....without any demur, reservation, contest, recourse or protest and/ or without any reference to the Contractor. Any such demand made by the Employer on the Bank shall be conclusive and binding as to the amount claimed by the Employer under this guarantee notwithstanding any difference between the Employer and the contractor or any dispute pending before any Court, Tribunal, Arbitrator or any other authority. The Bank undertakes not to revoke this guarantee during its currency without previous consent of the employer and further agrees that the guarantee herein contained shall be enforceable till ninety (90) days after expiry of its validity.

The Employer shall have the fullest liberty without affecting in any way the liability of the Bank under this guarantee, from time to time to vary the advance or to extend the time for performance of the Contract by the Contractor. The Employer shall have the fullest liberty without affecting this guarantee, to postpone from time to time the exercise of any powers vested in them or of any right which they might have against the Contractor, and to exercise the same at any time in any manner, in the Contract between the Employer and the contractor or any other course or remedy or security available to the Employer. The Bank shall not be released of its obligations under these presents by any exercise by the Employer of its liberty with reference to the matters aforesaid or any of them or by reason of any other act or forbearance or other acts of omission or commission on the part of the Employer or any other



Signature
Subject: CN=DEEPAK MITTAL, ST=DELHI, O=D 3 5 4 17=110003, OU=CONTRACTS AN
User ID : deepak.mittal

indulgence shown by the Employer or by any other matter or thing whatsoever which under law would but for this provision, have the effect of relieving the Bank.

The Bank also agrees that the Employer at its option shall be entitled to enforce this Guarantee against the Bank as a principal debtor, in the first instance without proceeding against the Contractor and notwithstanding any security or other guarantee that the Employer may have in relation to the Contractor's liabilities.

Notwithstanding anything contained hereinabove our liability under this guarantee is limited to(advance amount)..... and it shall remain in force up to and including.....(#)..... and shall be extended from time to time for such period (not exceeding one year). As may be desired by M/s.....(Contractor's Name).....on whose behalf this guarantee has been given.

Dated thisday of20.....at.....

WITNESS:

(Name).....

(Signature).....

(Name).....

(Signature)

Stamp) (Designation with Bank

Attorney as per Power Of Attorney No.....

Dated.....

Notes:

1. (#) this date shall be ninety (90) days beyond the date of Completion of the Facilities.
2. The stamp papers of appropriate value shall be purchased in the name of guarantee issuing Bank.

NOTE:

Complete mailing address of the Head Office of the Bank to be given.

The bank guarantee validity date shall be forty five (45) days after the last date for which the bid is valid.

The Stamp Paper of appropriate value shall be purchased in the name of guarantee issuing Bank.

The Bank Guarantee shall be issued on a stamp paper of value as applicable in the State of the issuing bank in India or the State of Delhi in India or the State of India from where the BG shall be operated, whichever is higher.

While getting the Bank Guarantee issued, Bidders are required to ensure compliance to the Bank Guarantee Verification Check List.



Signature :-
Subject : CN=DEEPAK MITTAL, ST=DELHI, OID.2.5.4.17=110003, OU=CONTRACTS AN
PROCUREMENT, O=ENERGY EFFICIENCY SERVICES LIMITED, C=IN
User ID : deepak.mittal
Serial No : F3FA77

**PROFORMA OF LETTER OF UNDERTAKING
(TO BE FURNISHED ON NON-JUDICIAL STAMP PAPER OF APPROPRIATE VALUE)**

[To be executed by the Holding Company Supported by Board Resolution and submitted by the Bidder along with the Bid, in case financial support is being extended by the Holding Company to the Bidder for meeting the stipulated Financial Qualifying]

Ref. : NIT/Bid Document No.:

Our Reference NoDate :

Bidder's Name and Address :

To,

CGM (SCM),
Energy Efficiency Services Limited,
Core-3, 6th Floor,
SCOPE Complex,
Lodhi Road, New Delhi-110003
Dear Sir,

1.0 We, M/s..... (Name of the Holding Company) declare that we are the holding company of M/s..... (Name of the Bidder) and have controlling interest therein.

M/s..... (Name of the Bidder) proposes to submit the bid for the package (Name of the package) for (Name of the Project) under bid reference no..... dated and have sought financial strength and support from us for meeting the stipulated Financial Qualifying Requirement as per Clause Section 3 and its subsequent amendment.

2.0 We hereby undertake that we hereby pledge our unconditional & irrevocable financial support for the execution of the said package to M/s..... (Name of the Bidder), for the execution of the Contract, in case they are awarded the Contract for the said package at the end of the bidding process. We further agree that this undertaking shall be without prejudice to the various liabilities that M/s..... (Name of Bidder) would be required to undertake in terms of the Contract including the Performance Security as well as other obligations of M/s.....(Name of the Bidder).



Signature :-
Subject : CN=DEEPAK MITTAL, ST=DELHI, OID.2.5.4.17=110003, OU=CONTRACTS AN
PROCUREMENT, O=ENERGY EFFICIENCY SERVICES LIMITED, C=IN
User ID : deepak.mittal
Serial No : F3FA77

3.0 This undertaking is irrevocable and unconditional, and shall remain in force till the successful execution and performance of the entire contract and/or till it is discharged by EESL.

4.0 We are herewith enclosing a copy of the Board Resolution in support of this undertaking.

Witness:

Yours faithfully,

(1)

(Signature of Authorized Signatory)

on behalf of the Holding Company

(2)

Name & Designation

Name of the Holding Company

(Seal of Holding Company)



Signature :-
Subject : CN=DEEPAK MITTAL, ST=DELHI, OID.2.5.4.17=110003, OU=CONTRACTS AND
PROCUREMENT, O=ENERGY EFFICIENCY SERVICES LIMITED, C=IN
User ID : deepak.mittal
Serial No : F3FA77

REAL TIME GROSS SETTLEMENT (RTGS)/ NATIONAL ELECTRONIC FUND TRANSFER (NEFT)

From: M/s _____

Sub: RTGS/NEFT Payments

We are agree to accept admissible payments through electronic mode viz RTGS/NEFT. For this, we are providing the requisite information herein below. The RTGS/NEFT charges for the above facility may be deducted/Recovered from our admissible payment.

Name Of City	
Bank Code No.	
Branch Code No.	
Bank's Name	
Branch Address	
Branch Telephone/ Fax No.	
Supplier Account No.	
Type of Account	
IFSC Code for NEFT	
IFSC Code for RTGS	
Supplier's name as per Account	
Telephone No. of Supplier	
Supplier's E-mail ID	
GST No. of the supplier	

A cancelled cheque against above bank account number is also being enclosed.

Encl: As above:-

Confirmed by Banker
With SealSignature of supplier
With stamp & Address

Signature :-
Subject : CN=DEEPAK MITTAL, ST=DELHI, OID.2.5.4.17=110003, OU=CONTRACTS AN
PROCUREMENT, O=ENERGY EFFICIENCY SERVICES LIMITED, C=IN
User ID : deepak.mittal
Serial No : F3FA77

(Declaration for Quantity Quoted by the Bidder)

Ref. NIT/Bid Document No.: _____.

{Description: _____}

To,

**CGM (SCM),
Energy Efficiency Services Limited,
Core-3, 6th Floor,
SCOPE Complex,
Lodhi Road, New Delhi-110003**

Sub.: **Declaration for the Quantity Quoted by bidder in the Tendered Delivery Period**

Ref. above Tender, I/we (on behalf of M/s.....) hereby admit that I/we, have quoted for the following Clusters in the above-referred Tender.

Work Package	Cluster No.	Participated (Yes/No)
<i>Design, Manufacture, Supply, Transport, Installation, Testing and Commissioning of approximate 1,75,000 numbers of Off Grid Solar Photovoltaic Water Pumping Systems in selected States on PAN India basis, including complete system warranty and its repair and maintenance for 5 Years under MNRE off-grid and decentralized solar PV applications scheme on behalf of State Nodal Agencies (SNAs).</i>	Cluster 1	
	Cluster 2	
	Cluster 3	
	Cluster 4	
	Cluster 5	
	Cluster 6	
	Cluster 7	
	Cluster 8	
	Cluster 9	
	Cluster 10	

Signature of bidder
With stamp & Address

(*bidder has to mandatorily submit the declaration as above. The bid shall be evaluated on the basis of this declaration. Providing false information may lead to technically non-responsiveness of the bid.)



Signature :-
Subject : CN=DEEPAK MITTAL, ST=DELHI, OID.2.5.4.17=110003, OU=CONTRACTS AN
PROCUREMENT, O=ENERGY EFFICIENCY SERVICES LIMITED, C=IN
User ID : deepak.mittal
Serial No : F3FA77